







- | | | | |
|---|---|-------------|------------------|
| 1 |  | 2000.725 | Werkplatte |
| 2 |  | 3909.081 | Winkelhebelwelle |
| 3 |  | 3112.041.CO | Grossbodenrad |



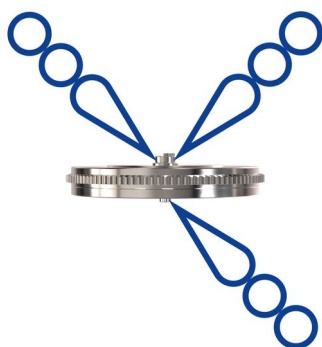

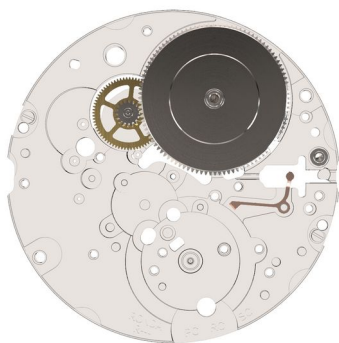

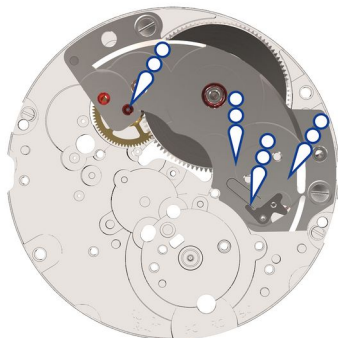

- | | | | |
|---|---|--------|--|
| 4 |  | HP1300 | Moebius HP1300
Ölen der Federwelle von nachfolgendem Artikel. |
|---|---|--------|--|







- | | | | |
|---|---|------------------|------------|
| 5 |  | 3100.054.CO.1140 | Federhaus |
| 6 |  | 3016.035 | Stopphebel |





7		2010.028	Federhausbrücke
8		4000.357	Schraube
9		4000.357	Schraube
10		3500.087	Klinke
11		3905.086	Feder für Klinke
12		HP1300	Moebius HP1300



13		3008.030.TA	Kronrad
14		2130.237	Kronradkern
15		4000.358	Schraube
16		4000.358	Schraube



17		3002.030.FI	Aufzugtrieb
18		3001.074.FI	Kupplungstrieb

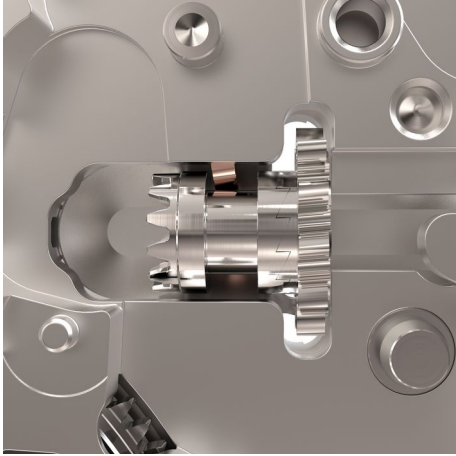

19

Position des Stophebels

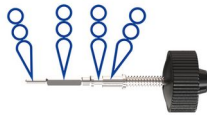

20



HP1300

Moebius HP1300

Ölen vor dem Einbau des nachfolgenden Artikels.

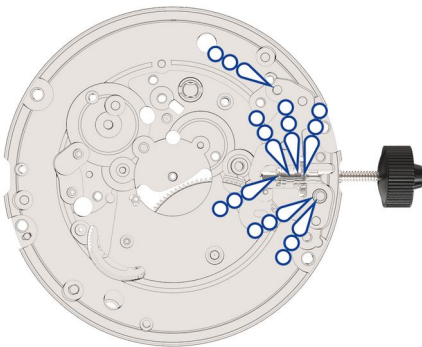

21



3000.214.CO

Arbeitsaufzugswelle L18.54mm





22



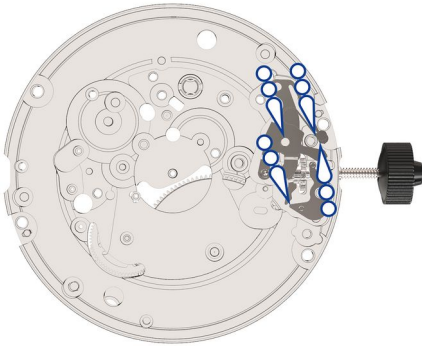



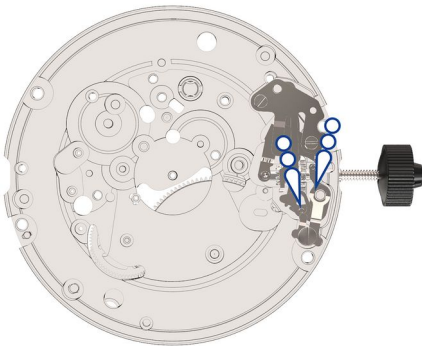

HP1300

Moebius HP1300





23		3017.066	Winkelhebel
24		3015.101	Wippe (3 Positionen)
25		3015.105.CO	Wippe für Zeigerstellrad
26		HP1300	Moebius HP1300

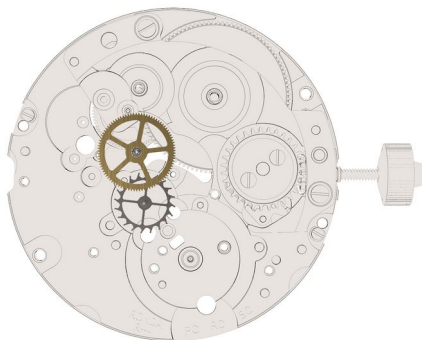

27		3905.092	Winkelhebelraste (3 Positionen)
28		4000.360	Schraube
29		4000.360	Schraube
30		3905.088	Winkelhebelfeder
31		4000.357	Schraube
32		HP1300	Moebius HP1300



33		3240.034.CO	Hemmungsrad
34		3122.079.CO	Kleinbodenrad



35



9010--9010s

Moebius 9010 / 9010 sehr kleine Menge

Ölen der Sekundenachse von nachfolgendem Artikel.

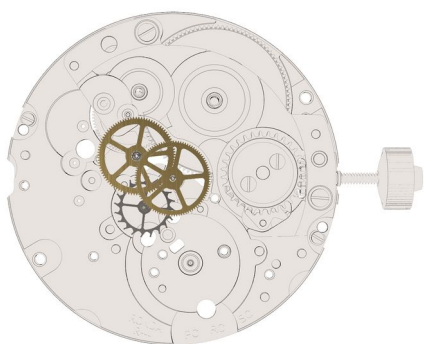

36



3136.222.CO

Sekundenrad (Aig.)

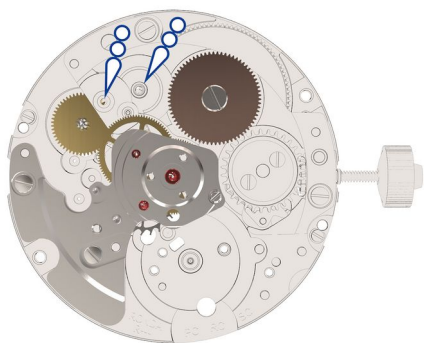

37



2020.214

Räderwerkbrücke

38



4000.357

Schraube

39



4000.357

Schraube

40



4000.362

Schraube

41



3011.048.TA

Sperrrad

42



4000.359

Schraube

43

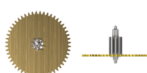

3400.031.CO

Reduktionsrad 1







44

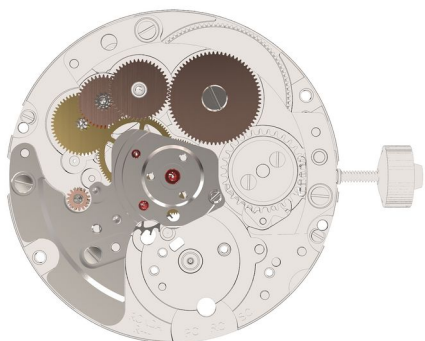

HP1300

Moebius HP1300





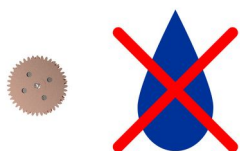

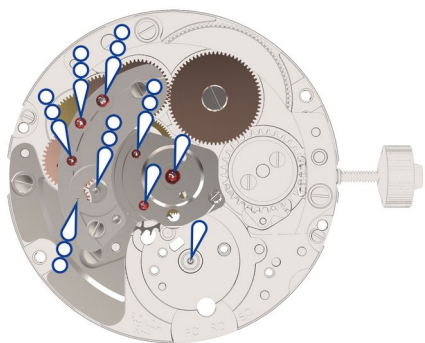

- | | | | | |
|----|---|---|-------------|----------------------|
| 45 |  |  | 3400.032.CO | Reduktionsrad 2 |
| 46 |  |  | 3004.259.TA | Wippenaufzugsrad |
| 47 |  |  | 3004.270.CO | Umkehrverbindungsrad |



- 48 Hinweis zu nachfolgendem Artikel:
Waschen nicht empfohlen. Stark verschmutzte oder rostige Teile sollen durch tauchgeschmierte Ersatzteile von Ronda AG ersetzt werden.



- | | | | | |
|----|---|---|--------------|-------------------------------|
| 49 |  |  | 3004.257.CO3 | Umkehrrad |
| 50 |  | | 2110.025 | Brücke für Automatik |
| 51 |  | | 4000.358 | Schraube |
| 52 |  | | 4000.358 | Schraube |
| 53 |  | | HP1300--9010 | Moebius HP1300 / Moebius 9010 |

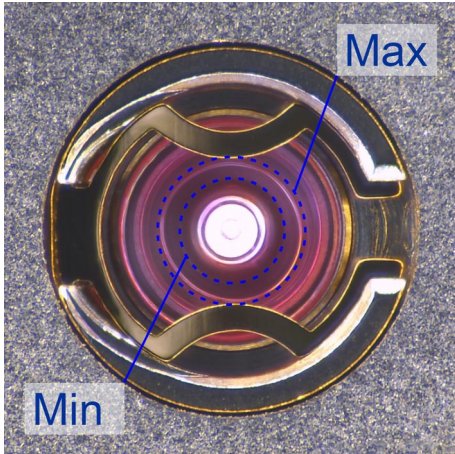

54

Ölmenge in Stossicherungen für Unruh

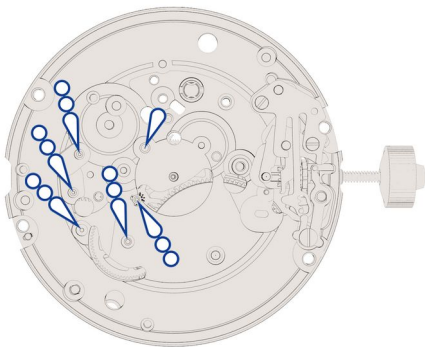

55



HP1300--9010

Moebius HP1300 / Moebius 9010



56





Vorsicht bei der Reinigung !

Das Waschen in einer Reinigungslösung wird bei nachfolgendem Artikel nicht empfohlen.

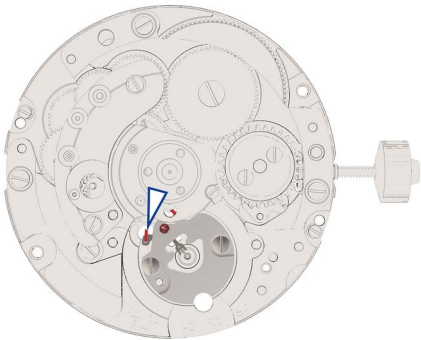

Vorsichtshalber mit Rodico und Alkohol reinigen.









57		3238.007.CO3	Anker
58		2040.025	Ankerbrücke
59		4000.357	Schraube
60		4000.357	Schraube
61		9415	Moebius 9415

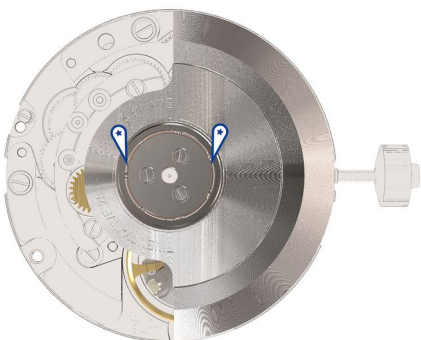

62		2050.047.CO4	Unruhbrücke
63		4000.357	Schraube
64		9010	Moebius 9010



65		3004.250.CO	Rad für Schwungmasse
66		2120.034.CO	Schwungmasse
67		4000.361	Schraube
68		4000.361	Schraube
69		4000.361	Schraube
70		9010s	Moebius 9010 sehr kleine Menge

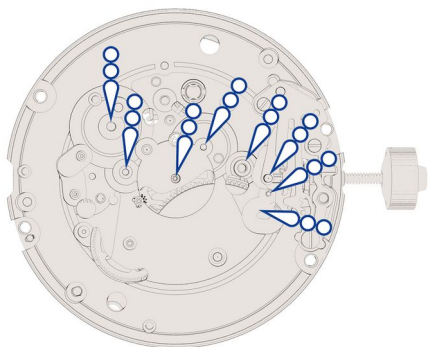

71



HP1300

Moebius HP1300

72

Hinweis zu nachfolgendem Artikel:
Waschen nicht empfohlen. Stark verschmutzte oder rostige Teile sollen durch tauchgeschmierte Ersatzteile von Ronda AG ersetzt werden.



73



3305.393.CO

Minutenrohr (Aig.)

74

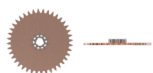

3007.093.CO

Wechselrad

75



3004.262.TA

Zwischen-Zeigerstellrad

76



3004.277.TA

Zeigerstellrad

77



3004.265.TA

Zwischenverbindungsrad für Korrektor

78



3507.075.CO

Datumkorrektor

79



3004.255.CO2

Datumsanzeiger-Mitnehmerrad

80



3504.245.AA.1.A

Datumsanzeiger (T3, G3)

81



HP1300

Moebius HP1300

Ölen vor dem Einbau des nachfolgenden Artikels.



82



3500.084.CO

Datumraste

83



2130.239

Halteplatte für Datumanzeige

84



4000.360

Schraube

85



4000.360

Schraube

86



4000.360

Schraube

87



HP1300

Moebius HP1300



88



3301.336.TA

Stundenrad (Aig.)

89



3315.003

Friktionsfeder