

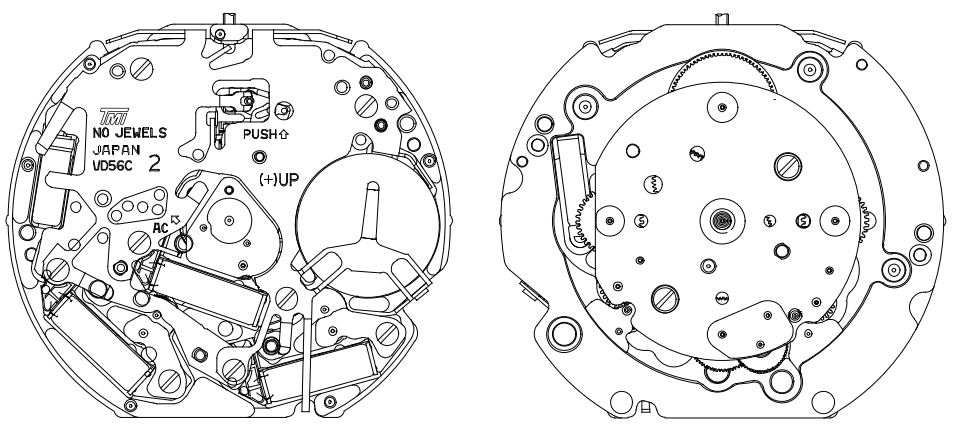



**TECHNICAL GUIDE  
&  
PARTS CATALOGUE**

**Cal.VD56C**

**ANALOGUE QUARTZ**

Item		Cal. No.	VD56C
Movement			
Movement size	Outside diameter	(φD)	(3H - 9H) (12H - 6H) φ29.50 mm × 26.00 mm × —
	Casing diameter	(φD)	(3H - 9H) (12H - 6H) φ28.80 mm × — × —
	Total height	3.97 mm	
Time indication		3 Hands (Hour, Minute, Second) Chronograph (Minute, Second, 1/10 second) 24 hour indicator	
Driving system		Two pole stepping motor Step motor 3 pieces	
Additional mechanism		Electronic circuit reset switch Second setting device [ Time ] Indicated by the Hour, Minute, Second and 24 hour hands [ Stop watch ] Up to 1 minute in 1/10 second (2 seconds per round) Up to 60 minutes in 1 second split time	
Antimagnetic		≥ 1600 A/m	
Accuracy		Less than ± 20 seconds : Monthly rate at normal temperature range	
Battery		SR920SW (SEIZAIKEN) Silver oxide battery φ9.5 × t 2.0 mm Battery life is approximately 3 years	
Measuring gate by quartz tester		Use 10 second gate *Set the winding stem with crown at the normal position	
Jewels		0 Jewel	

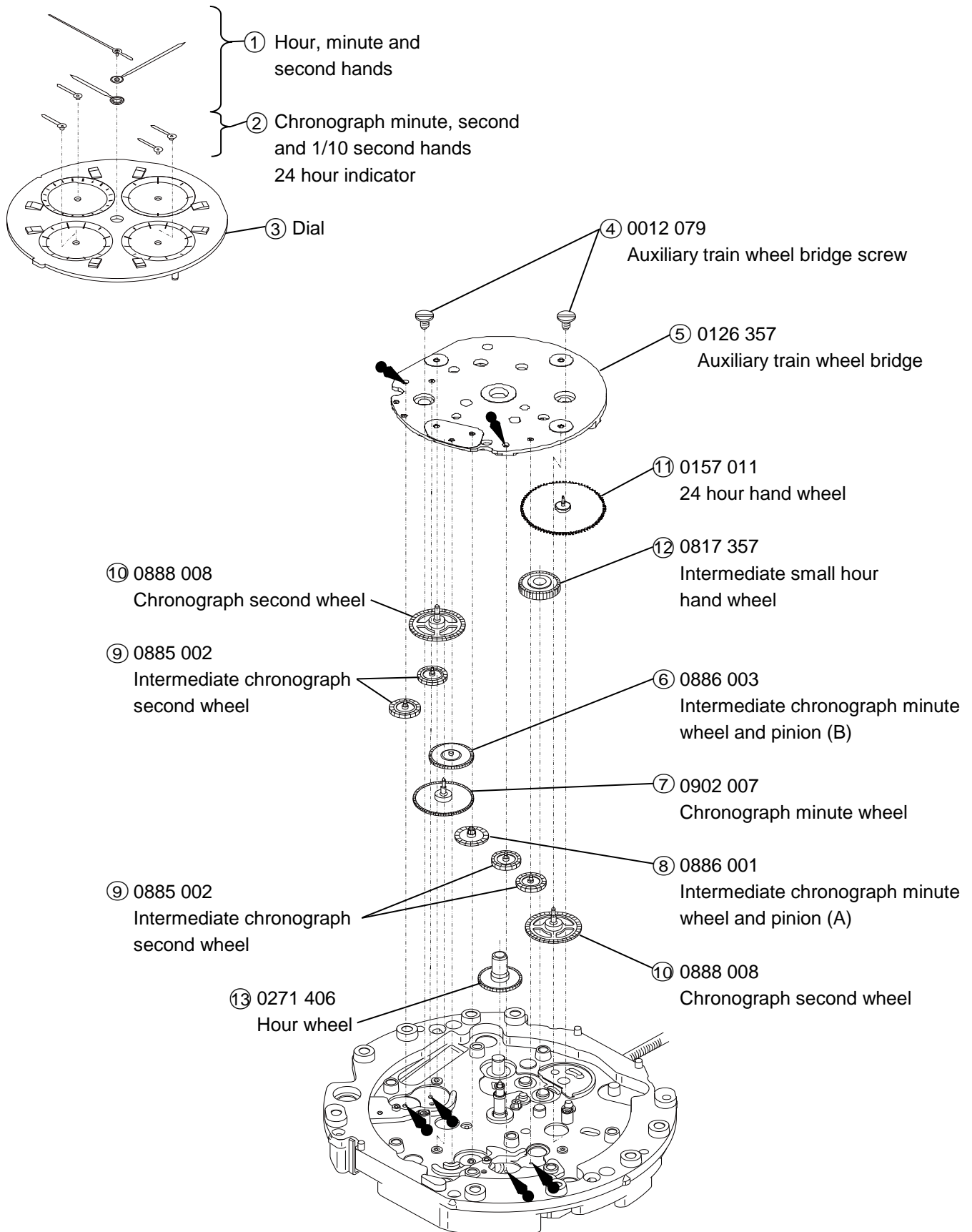

Disassembling procedures Figs. ① → ④⑤	Lubricating : Types of oil	
		A3a / Moebius 9010
Reassembling procedures Figs. ④⑤ → ①		A2a / Moebius 9030
		A3a (S-6)
Oil quantity		Normal quantity



Disassembling procedures Figs. ① → ④⑤





Reassembling procedures Figs. ④⑤ → ①

Lubricating : Types of oil

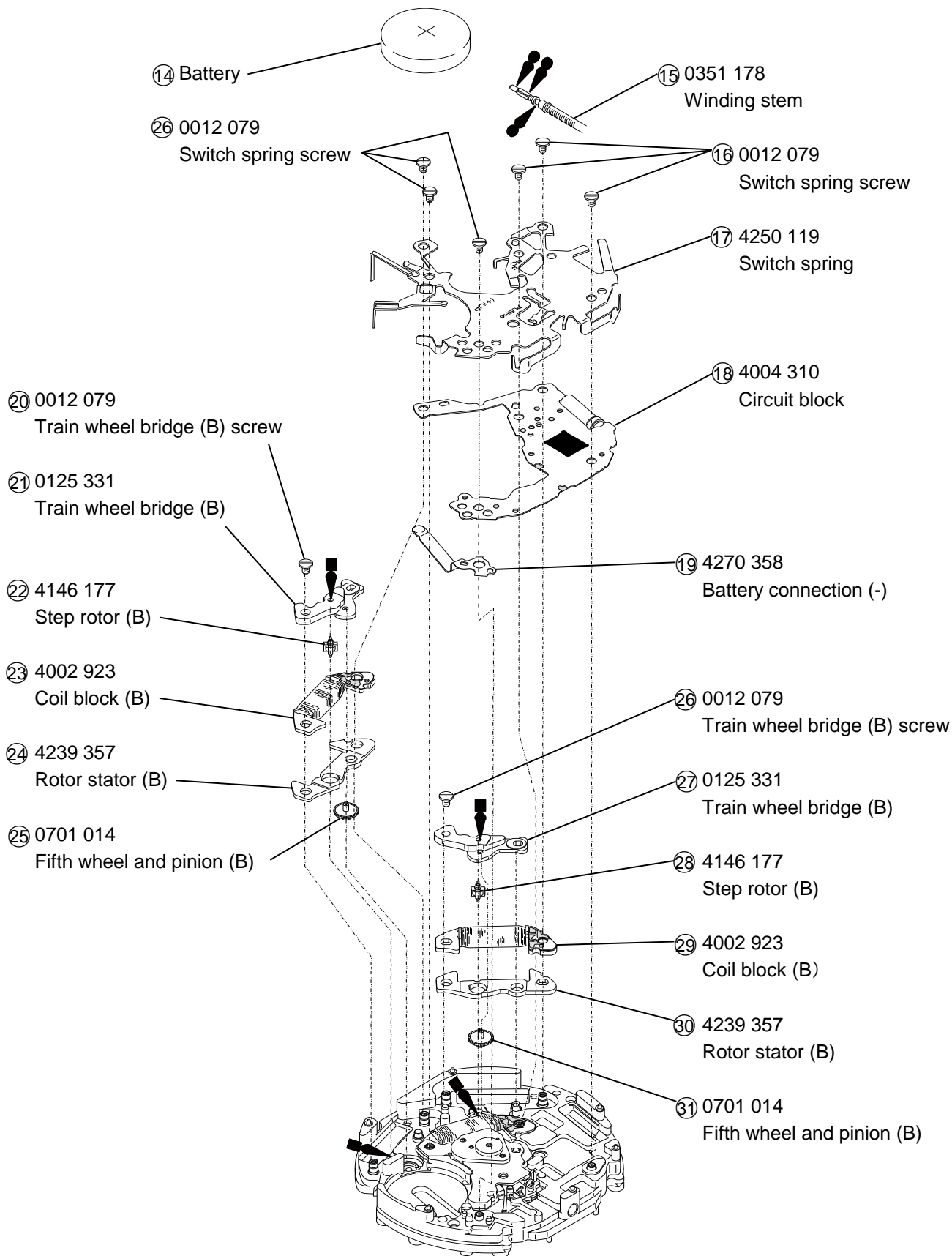
-  A3a / Moebius 9010
-  A2a / Moebius 9030
-  A3a (S-6)

Oil quantity  Normal quantity



Disassembling procedures Figs. ① → ④⑤	Lubricating : Types of oil
Reassembling procedures Figs. ④⑤ → ①	 A3a / Moebius 9010  A2a / Moebius 9030  A3a (S-6)
	Oil quantity  Normal quantity

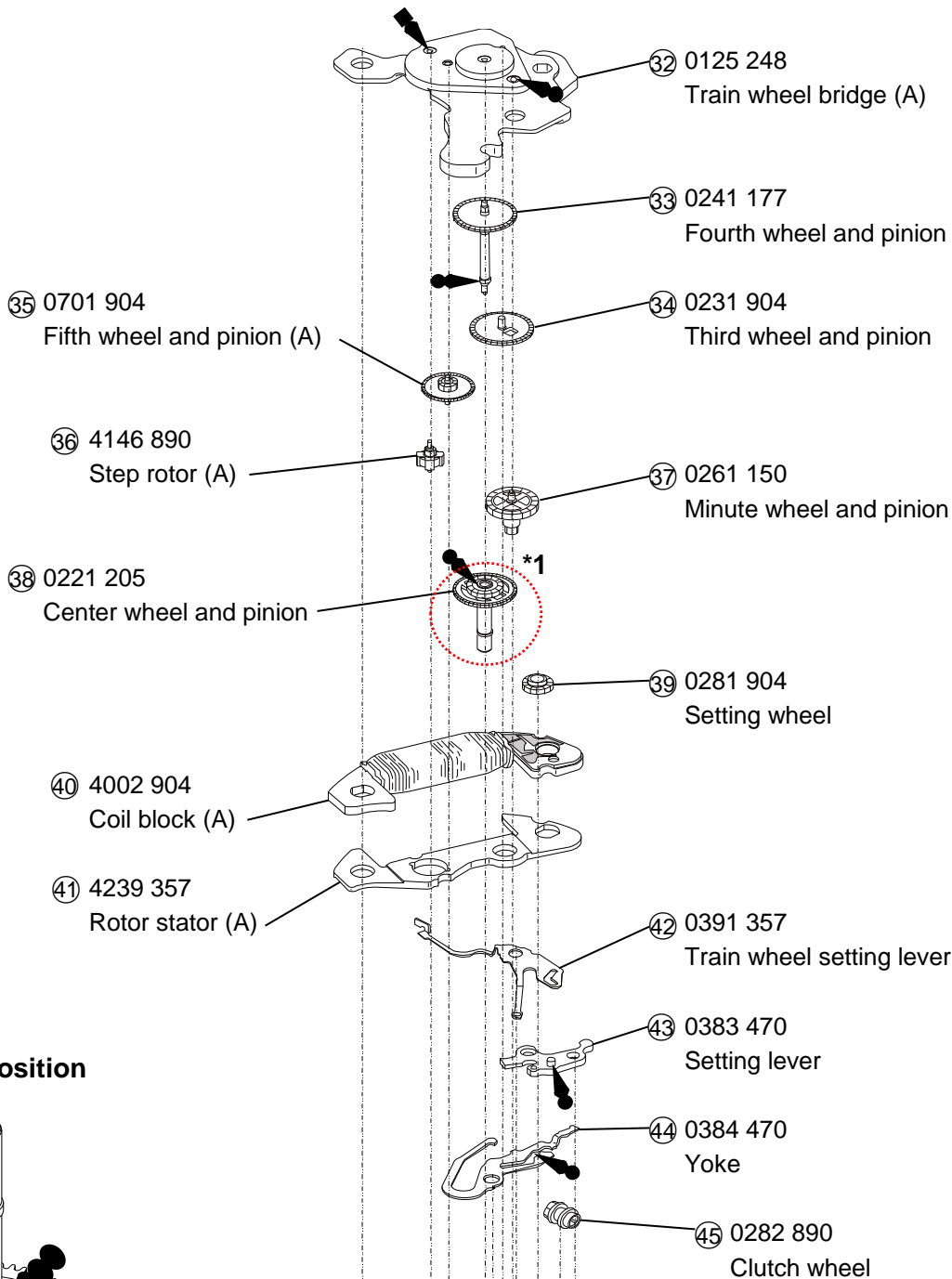

**\*1 Oiling position**

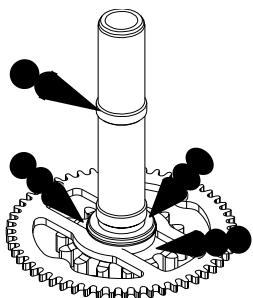

•The explanation here is only for the particular point of Cal.VD56C

## 1.REMARKS ON INSTALLING THE BATTERY

- 1) After the battery is replaced with a new one or after the battery is reinstalled following the repairing procedures, Be sure to touch the short-circuit the AC terminal of circuit block and the switch spring with conductive tweezers to reset the circuit as illustrated at right.

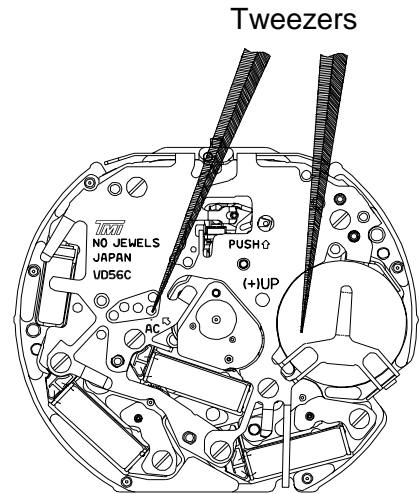

- 2) When the battery replaced with a new one, the time information stored in the built-in IC and the time indicated by the stopwatch hands do not correspond with each other. Reset the stopwatch hands to "0" position following the procedure below. If the stopwatch hands should move improperly, also follow the same procedure.

## ORDER

- ① Pull out the crown.
- ② Keep buttons "A" and "B" pressed at the same time for 2 seconds, and then, release the buttons. The stopwatch second hand move back and returned to where it was.
- ③ Press button "A" or "B" to reset the stopwatch second and minute hands to "0" position.
  - \* By pressing button "A", set the stopwatch 1/10 second hand.
  - \* By pressing button "B", set the stopwatch second and minute hands.
- ④ Turn the crown to set the hour, minute and 24 hour hands to the desired time, and push the crown back to the normal position.

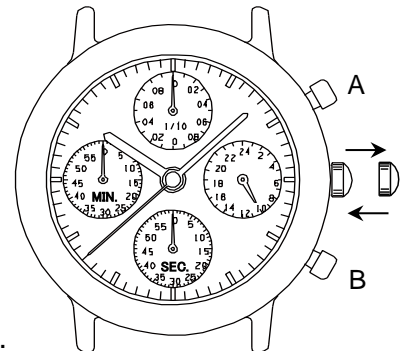

## 2.REMARKS ON DISASSEMBLING AND REASSEMBLING

### (1) Hand

•How to install the hands

Please put on the metal plate so as to avoid 6 protrusions.(Right figure: place of red circle)

\*Install the hour, minute and second hands at the "12" o'clock position.

\*Install the chrono minute, second and 1/10 second hands "0" o'clock position.

\*Install the 24 hour indicator at the "24" position.

**[ Reference ]** The power of press hands

Minute & Hour Hands	< 5kg
Second Hand	< 5kg
Chrono Minute & Second & 1/10 second hands	< 3kg
24 hour indicator	< 3kg

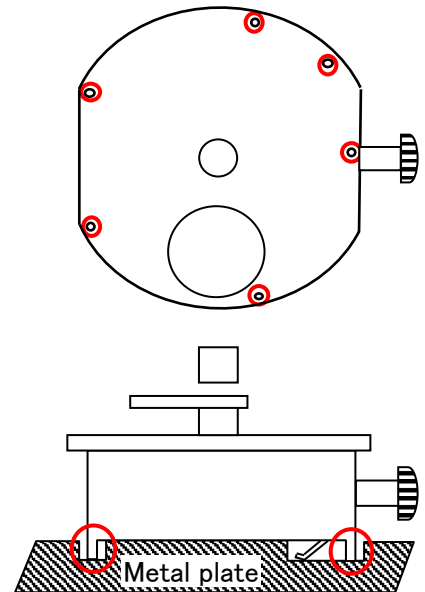

### (2) Battery

•How to install the battery

① Remove the hook of the switch springs battery clamp portion.

② Insert the battery sideways, and have the hook of the switch springs battery clamp portion catch the main plate.

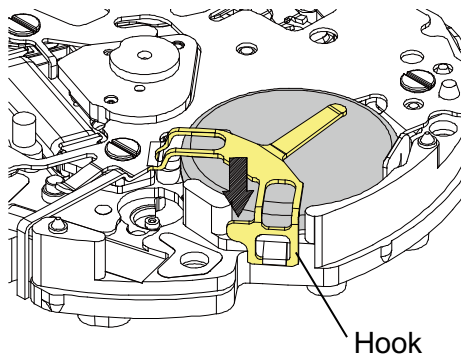

Battery clamp position

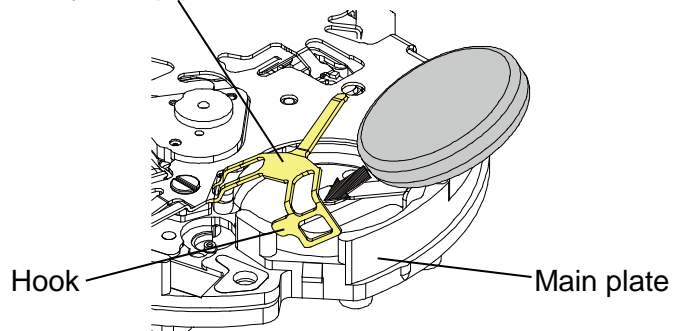

### (3) Winding stem

•How to remove

While pushing the indented portion of the arrow pull out the winding stem.

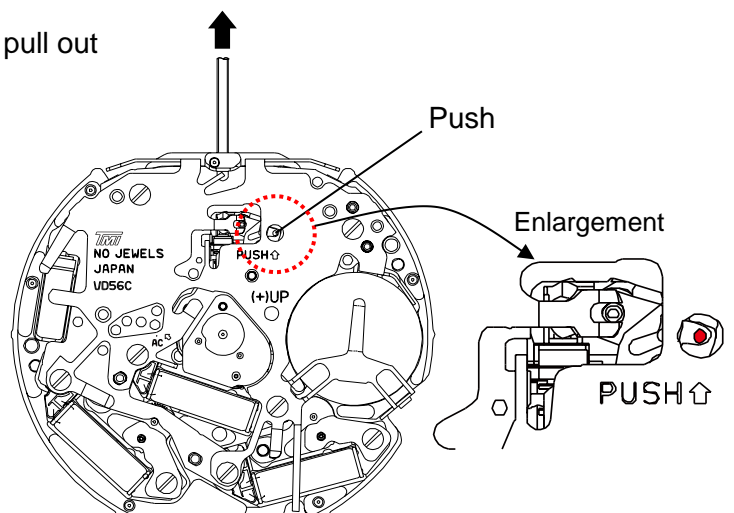

## DISPLAY AND CROWN / BUTTON OPERATION

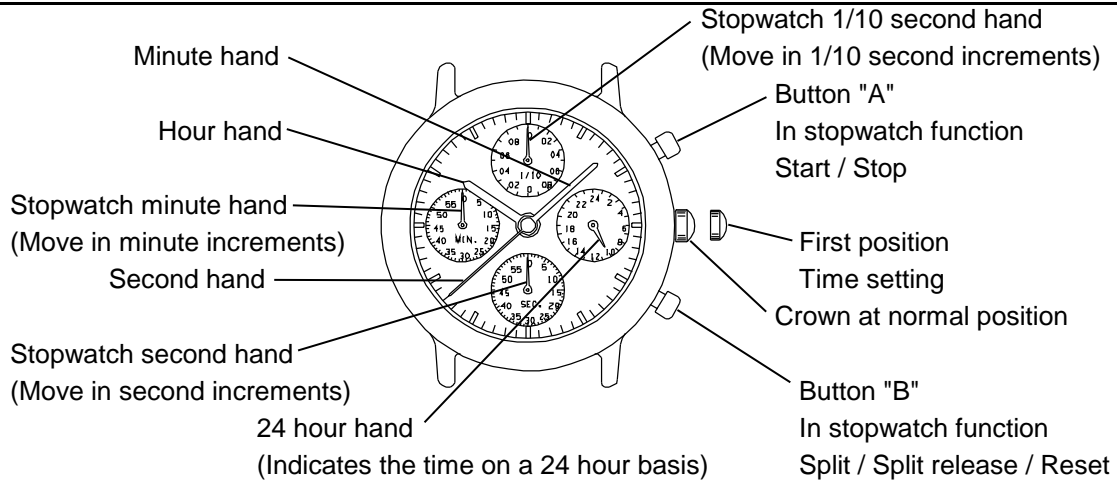

- \*The measurement time indicated by the stopwatch hands that move independently of center hands.
- \*Stopwatch 1/10 second hand moves for a first minute.  
After one minute, it indicates the measurement time when it is stopped.

## ADJUSTING THE STOPWATCH HAND POSITION

Before setting the time, check if the stopwatch 1/10 second, second and minute hands are in the "0" (12 o'clock) position.

\*If the stopwatch is in use, press the button in the following order to reset it, and then, check if the hands return to "0" position. (For details, see "HOW TO USE THE STOPWATCH")

- \* If the stopwatch is counting : A → B
- \* If the stopwatch is stopped : B
- \* If the split time is displayed : B → A → B

If either of the stopwatch hands are not in the "0" position, reset them following the procedure below.

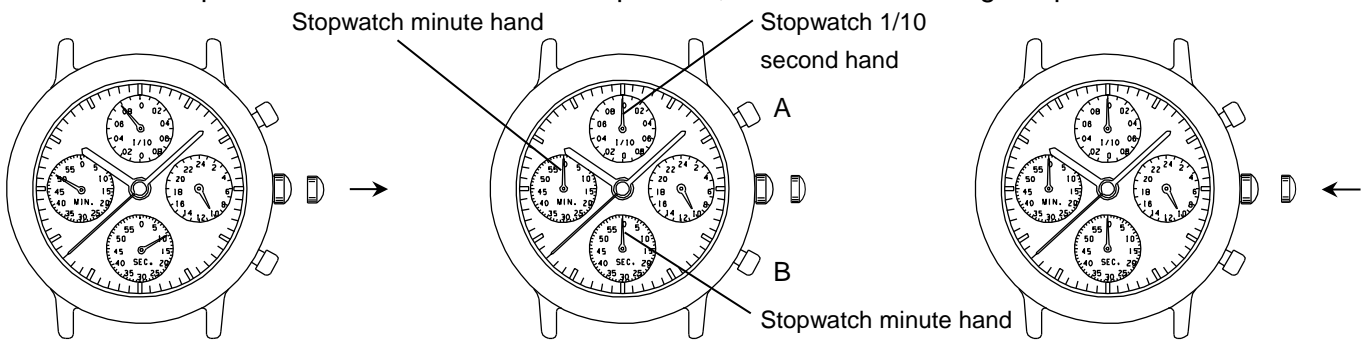

1.Pull out the crown.

2.Press button A or B to reset the stopwatch 1/10 second, second and minute hands to "0" position.

3.Push the crown back to the normal position.

- \*By pressing button A set the stopwatch 1/10 second hand.
- \*By pressing button B set the stopwatch second and minute hands.

- \*The stopwatch minute hand moves correspondingly with the stopwatch second hand.
- \*The hands move quickly if the respective buttons are kept pressed.



## TIME SETTING

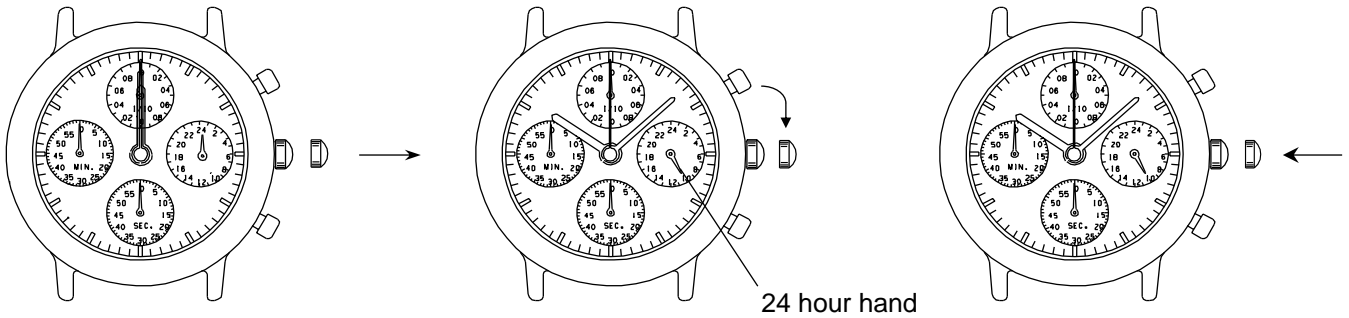

1. Pull out the crown to the second hand is at the 12 o'clock position. The second hand will stop on the spot.

\* Do not press any button. Otherwise, the chronograph hands will move.

2. Turn the crown to set the hour, minute and 24 hour hands to the desired time. As the hour hand moves, the 24 hour hand also moves correspondingly.

When setting the hour hand, check that the 24 hour hand is set properly.

3. Push the crown back in to the normal position in accordance with a time signal.

## HOW TO USE THE STOPWATCH

- The measurement time is indicated by the stopwatch hands that move independently of the center and 24 hour hands.
- The stopwatch can measure up to 60 minutes in 1/10 second.

(Standard measurement)

Ex) 100m race (Press the buttons in the following order A → A → B )

START → STOP (Finish) → RESET (Reset to "0'00")

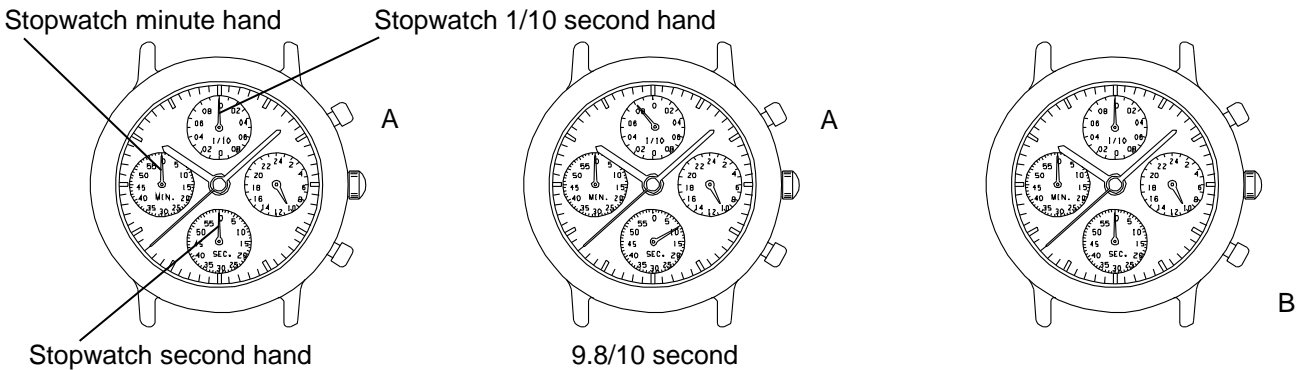

(Accumulated elapsed time measurement)

Ex) Basketball game (Press the buttons in the following order A → A / A → A → B )

START (Start of game) → STOP (Time out) / RESTART (Restart of game) → STOP (Game over) → RESET

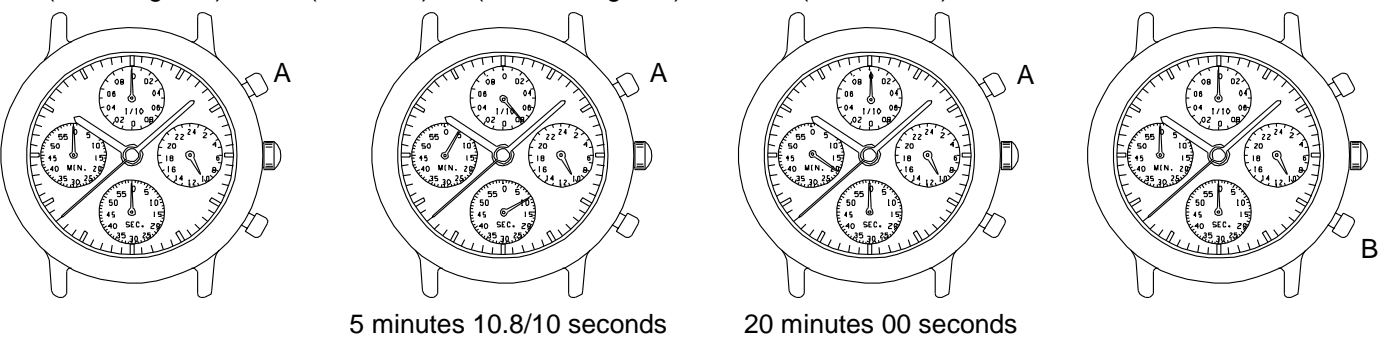

\*Restart and stop of the stopwatch can be repeated as many times as necessary by pressing button A.

(Split time measurement)

Ex.) 5,000m race (Press the buttons in the following order A → B / B → A → B )

START → SPLIT / SPLIT RELEASE → STOP → RESET

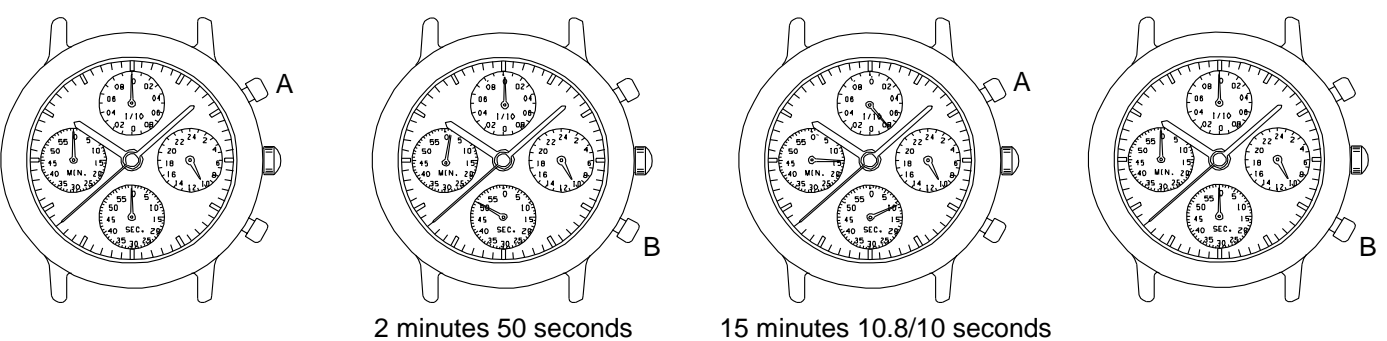

\*Measurement and release of the split time can be repeated as many times as necessary by pressing button B.