

LES ATELIERS ZENITH

EL PRIMERO

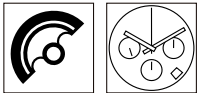

El Primero 400



PRINCIPALES CARACTÉRISTIQUES

Mouvement à remontage automatique commandé par une roue à colonnes
Remontage bidirectionnel par un rotor central monté sur roulement à billes
Diamètre d'encadrement: 30,00 mm
Hauteur totale du mouvement: 6,50 mm
Aiguille de petite seconde
Totalisateurs de 30 minutes et de 12 heures
Date: changement instantané
Mise à la date rapide par rotation de la couronne en position tirée de 2 crans
Réserve de marche: 50 heures
Fréquence: 36'000 alt/h
31 rubis
Angle de l'évée du balancier: 52°
Raquetterie avec réglage fin
Balancier annulaire, spiral autocompensateur

MAIN FEATURES

Self-winding chronograph movement co-ordinated by a column wheel
Bi-directional automatic winding with central ball bearing rotor
Casing diameter: 30.00 mm
Overall height: 6.50 mm
Small second hand
30 minutes & 12 hours recorders
Date: instantaneous change
Rapid date setting: by rotating the crown when it is pulled out two notches
Power reserve: 50 hours
Frequency: 36'000 vib/hr
31 jewels
Lift angle of the balance: 52°
Fine adjustment index-assembly
Annular balance, self-compensating hairspring

HAUPTMERKMALE

Uhrwerk mit automatischem Aufziehen von einem Säulenrad gesteuert
Schwungmasse auf Kugellager montiert, die Zugfeder in den beiden Richtungen ihrer Drehung aufzieht
Gehäusepassungs-Durchmesser: 30.00 mm
Totalhöhe: 6.50 mm
Kleiner Sekundenzeiger auf 9 Uhr
30-Minuten und 12-Stunden-Zähler
Datum: schnellschaltend
Datumschnellkorrektur durchs Umdrehen der Krone um 2 Kerben herausgezogen
Gangreserve: 50 Stunden
Frequenz: 36'000 Halbschwingungen/St.
31 Rubine
Hebungswinkel der Unruh: 52°
Rückervorrichtung mit Feinregulierung
Unruh mit glattem Reif, selbstkompensierte Spiralfeder

PRINCIPALI CARATTERISTICHE

Movimento cronografo automatico coordinato dalla ruota a colonna
Massa oscillante montata su cuscinetto a sfere, carica la molla motrice nei due sensi della sua rotazione
Diametro d'incassatura: 30,00 mm
Altezza totale del movimento: 6,50 mm
Piccola lancetta dei secondi alle nove
Totalizzatore 30 minuti e totalizzatore 12 ore
Data: cambiamento istantaneo
Cambio istantaneo della data mediante la corona posizione tirata di due livelli
Riserva di marcia: 50 ore
Frequenza: 36'000 alt/ora
31 Rubini
Angolo di leva del bilanciante: 52°
Racchetta con regolazione di precisione
Bilanciere anulare, spirale autocompensatore

El Primero 405



PRINCIPALES CARACTÉRISTIQUES

Mouvement à remontage automatique commandé par une roue à colonnes
 Remontage bidirectionnel par un rotor central monté sur roulement à billes
 Fonction «retour de vol» (flyback)
 Diamètre d'encadrement: 30,00 mm
 Hauteur totale du mouvement: 6,50 mm
 Aiguille de petite seconde
 Totalisateurs de 30 minutes et de 12 heures
 Date: changement instantané
 Mise à la date rapide par rotation de la couronne en position tirée de 2 crans
 Réserve de marche: 50 heures
 Fréquence: 36'000 alt/h
 31 rubis
 Angle de levée du balancier: 52°
 Raquetterie avec réglage fin
 Balancier annulaire, spiral autocompensateur

MAIN FEATURES

Self-winding chronograph movement co-ordinated by a column wheel
 Bi-directional automatic winding with central ball bearing rotor
 Fly-back function
 Casing diameter: 30.00 mm
 Overall height: 6.50 mm
 Small second hand
 30 minutes & 12 hours recorders
 Date: instantaneous change
 Rapid date setting: by rotating the crown when it is pulled out two notches
 Power reserve: 50 hours
 Frequency: 36'000 vib/hr
 31 jewels
 Lift angle of the balance: 52°
 Fine adjustment index-assembly
 Annular balance, self-compensating hairspring

HAUPTMERKMALE

Uhrwerk mit automatischem Aufziehen von einem Säulenrad gesteuert
 Schwungmasse auf Kugellager montiert, die Zugfeder in den beiden Richtungen ihrer Drehung aufzieht
 Fly-back-Funktion
 Gehäusepassungs-Durchmesser: 30.00 mm
 Totalhöhe: 6.50 mm
 Kleiner Sekundenzeiger auf 9 Uhr
 30-Minuten und 12-Stunden-Zähler
 Datum: schnellschaltend
 Datumschnellkorrektur durchs Umdrehen der Krone um 2 Kerben herausgezogen
 Gangreserve: 50 Stunden
 Frequenz: 36'000 Halbschwingungen/St.
 31 Rubine
 Hebungswinkel der Unruh: 52°
 Rückervorrichtung mit Feinregulierung
 Unruh mit glattem Reif, selbstkompensierte Spiralfeder

PRINCIPALI CARATTERISTICHE

Movimento cronografo automatico coordinato dalla ruota a colonna
 Massa oscillante montata su cuscinetto a sfere, carica la molla motrice nei due sensi della sua rotazione
 Funzione Fly-back
 Diametro d'incassatura: 30,00 mm
 Altezza totale del movimento: 6,50 mm
 Piccola lancetta dei secondi alle nove
 Totalizzatore 30 minuti e totalizzatore 12 ore
 Data: cambiamento istantaneo
 Cambio istantaneo della data mediante la corona posizione tirata di due livelli
 Riserva di marcia: 50 ore
 Frequenza: 36'000 alt/ora
 31 Rubini
 Angolo di leva del bilanciere: 52°
 Racchetta con regolazione di precisione
 Bilanciere anulare, spirale autocompensatore

El Primero 410

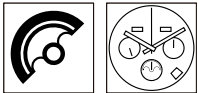

PRINCIPALES CARACTÉRISTIQUES

Mouvement à remontage automatique commandé par une roue à colonnes
Remontage bidirectionnel par un rotor central monté sur roulement à billes
Indication date, jour de la semaine, mois et des phases de la lune
Diamètre d'encadrement: 30,00 mm
Hauteur totale du mouvement: 7,55 mm
Aiguille de petite seconde
Totalisateurs de 30 minutes et de 12 heures
Date, jour de la semaine et mois: changement simultané et instantané
Mise à la date rapide: par rotation de la couronne en position tirée de 2 crans (position des aiguilles avant correction doit être sous l'axe virtuel 09:00 - 03:00) - Saut du mois au passage du 31 au 1
Changement rapide du jour de la semaine et de l'indication de phases de lune par pressions répétées sur le correcteur correspondant
Réserve de marche: 50 heures
Fréquence: 36'000 alt/h
31 rubis
Angle de levée du balancier: 52°
Raquetterie avec réglage fin
Balancier annulaire, spiral autocompensateur

MAIN FEATURES

Self-winding chronograph movement co-ordinated by a column wheel
Bi-directional automatic winding with central ball bearing rotor
Date, day, month & moonphase indications
Casing diameter: 30.00 mm
Overall height: 7.55 mm
Small second hand
30 minutes & 12 hours recorders
Date, day & month: instantaneous & simultaneous change
Rapid date setting: by rotating the crown when it is pulled out two notches (hands position must be below the virtual axis 9.00 - 03:00 on the dial) - Months change automatically while turning from 31 to 1
Rapid day & Moonphase setting: by pressing several times the correctors
Power reserve: 50 hours
Frequency: 36'000 vib/hr
31 jewels
Lift angle of the balance: 52°
Fine adjustment index-assembly
Annular balance, self-compensating hairspring

HAUPTMERKMALE

Uhrwerk mit automatischem Aufziehen von einem Säulenrad gesteuert
Schwungmasse auf Kugellager montiert, die Zugfeder in den beiden Richtungen ihrer Drehung aufzieht
Datum, Wochentag, Monat und Anzeige der Mondphase
Gehäusepassungs-Durchmesser: 30.00 mm
Totalhöhe: 7.55 mm
Kleiner Sekundenzeiger auf 9 Uhr
30-Minuten und 12-Stunden-Zähler
Simultaner und augenblicklicher Wechsel von Datum, Wochentag und Monat
Datumschnellkorrektur durchs Umdrehen der Krone um 2 Kerben herausgezogen (Zeigerstellung vor Korrektur unter Virtualachse 09:00 - 03:00) - Bei jedem Datumswechsel von 31 zu 1, dreht sich die Monatsangabe um eine Einheit weiter
Wochentageinstellung und Mondphasen: Korrektur mehrmals betätigen
Frequenz: 36'000 Halbschwingungen/St.
31 Rubine
Hebungswinkel der Unruh: 52°
Rückervorrichtung mit Feinregulierung
Spiralfeder

PRINCIPALI CARATTERISTICHE

Movimento cronografo automatico coordinato dalla ruota a colonna
Massa oscillante montata su cuscinetto a sfere, carica la molla motrice nei due sensi della sua rotazione
Data, giorno della settimana, mese, indicazione della fase lunare
Diametro d'incassatura: 30,00 mm
Altezza totale del movimento: 7,55 mm
Piccola lancetta dei secondi alle nove
Totalizzatore 30 minuti e totalizzatore 12 ore
Cambiamento istantaneo e simultaneo della data, del giorno della settimana e del mese
Aggiornamento rapido della data: con rotazione della corona in posizione tirata di due livelli (la posizione delle lancette prima della correzione deve essere sotto l'asse virtuale 09:00 - 03:00) - Salto del mese al passaggio dal 31 al 1
Cambiamento rapido del giorno della settimana et dell'indicazione delle fasi lunari con pressioni ripetute sul correttore corrispondente
Riserva di marcia: 50 ore
Frequenza: 36'000 alt/ore
31 Rubini
Angolo di leva del bilanciario: 52°
Racchetta con regolazione di precisione
Bilanciario anulare, spirale autocompensatore

El Primero 420

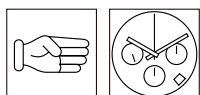

PRINCIPALES CARACTÉRISTIQUES

Mouvement à remontage manuel commandé par une roue à colonnes
Diamètre d'encadrement: 30,00 mm
Hauteur totale du mouvement: 5,70 mm
Aiguille de petite seconde
Totalisateurs de 30 minutes et de 12 heures
Date: changement instantané
Mise à la date rapide par rotation de la couronne en position tirée de 2 crans
Réserve de marche: 50 heures
Fréquence: 36'000 alt/h
31 rubis
Angle de lèvement du balancier: 52°
Raquetterie avec réglage fin
Balancier annulaire, spiral autocompensateur

MAIN FEATURES

Hand winding chronograph movement co-ordinated by a column wheel
Casing diameter: 30.00 mm
Overall height: 5.70 mm
Small second hand
30 minutes & 12 hours recorders
Date: instantaneous change
Rapid date setting: by rotating the crown when it is pulled out two notches
Power reserve: 50 hours
Frequency: 36'000 vib/hr
31 jewels
Lift angle of the balance: 52°
Fine adjustment index-assembly
Annular balance, self-compensating hairspring

HAUPTMERKMALE

Uhrwerk mit automatischem Aufziehen von einem Säulenrad gesteuert
Gehäusepassungs-Durchmesser: 30.00 mm
Totalhöhe : 5.70 mm
Kleiner Sekundenzeiger auf 9 Uhr
30-Minuten und 12-Stunden-Zähler
Datum: schnellschaltend
Datumschnellkorrektur durchs Umdrehen der Krone um 2 Kerben herausgezogen
Gangreserve: 50 Stunden
Frequenz: 36'000 Halbschwingungen/St.
31 Rubine
Hebungswinkel der Unruh: 52°
Rückervorrichtung mit Feinregulierung
Unruh mit glattem Reif, selbstkompensierte Spiralfeder.

PRINCIPALI CARATTERISTICHE

Movimento cronografo manuale coordinato dalla ruota a colonna
Diametro d'incassatura : 30,00 mm
Altezza totale del movimento : 5,70 mm
Piccola lancetta dei secondi alle nove
Totalizzatore 30 minuti e totalizzatore 12 ore
Data: cambiamento istantaneo
Cambio istantaneo della data mediante la corona posizione tirata di due livelli
Riserva di marcia: 50 ore
Frequenza: 36'000 alt/ore
31 Rubini
Angolo di leva del bilanciere: 52°
Racchetta con regolazione di precisione
Bilanciere anulare, spirale autocompensatore

El Primero 4001



PRINCIPALES CARACTÉRISTIQUES

Mouvement à remontage automatique commandé par une roue à colonnes
Remontage bidirectionnel par un rotor central monté sur roulement à billes
Fonction « retour de vol » (flyback)
Indication date, jour de la semaine, mois et des phases de la lune
Diamètre d'encastrement: 30,00 mm
Hauteur totale du mouvement: 7,55 mm
Aiguille de petite seconde
Totalisateurs de 30 minutes et 12 heures
Date, jour de la semaine et mois: changement simultané et instantané
Mise à la date rapide: par rotation de la couronne en position tirée de 2 crans (position des aiguilles avant correction doit être sous l'axe virtuel 09:00 -03:00) -Saut du mois au passage du 31 au 1.
Changement rapide du jour de la semaine et de l'indication de phases de lune par pressions répétées sur le correcteur correspondant
Réserve de marche: 50 heures
Fréquence: 36'000 alt/h
31 rubis
Angle de levée du balancier: 52°
Raquetterie avec réglage fin
Balancier annulaire, spiral autocompensateur

MAIN FEATURES

Self-winding chronograph movement co-ordinated by a column wheel
Bi-directional automatic winding with central ball bearing rotor
Fly-back function
Date, day, month & moonphase indications
Casing diameter: 30.00 mm
Overall height: 7.55 mm
Small second hand
30 minutes & 12 hours recorders
Date, day & month: instantaneous & simultaneous change
Rapid date setting: by rotating the crown when it is pulled out two notches (hands position must be below the virtual axis 9.00 - 03:00 on the dial) - Months change automatically while turning from 31 to 1
Rapid day & Moonphase setting: by pressing several times the correctors
Power reserve: 50 hours
Frequency: 36'000 vib/hr
31 jewels
Lift angle of the balance: 52°
Fine adjustment index-assembly
Annular balance, self-compensating hairspring

HAUPTMERKMALE

Uhrwerk mit automatischem Aufziehen von einem Säulenrad gesteuert
Schwungmasse auf Kugellager montiert, die Zugfeder in den beiden Richtungen ihrer Drehung aufzieht
Fly-back-Funktion
Datum, Wochentag, Monat und Anzeige der Mondphase
Gehäusepassungs-Durchmesser: 30.00 mm
Totalhöhe: 7.55 mm
Kleiner Sekundenzeiger auf 9 Uhr
30-Minuten und 12-Stunden-Zähler
Simultaner und augenblicklicher Wechsel von Datum, Wochentag und Monat
Datumschnellkorrektur durchs Umdrehen der Krone um 2 Kerben herausgezogen (Zeigerstellung vor Korrektur unter Virtualachse 09:00 -03:00) - Bei jedem Datumswechsel von 31 zu 1, dreht sich die Monatsangabe um eine Einheit weiter
Wochentageinstellung und Mondphasen: Korrektor mehrmals betätigen
Gangreserve: 50 Stunden
Frequenz: 36'000 Halbschwingungen/St.
31 Rubine
Hebungswinkel der Unruh: 52°
Rückvorrückung mit Feinregulierung
Unruh mit glattem Reif, selbstkompensierte Spiralfeder.

PRINCIPALI CARATTERISTICHE

Movimento cronografo automatico coordinato dalla ruota a colonna
Massa oscillante montata su cuscinetto a sfere, carica la molla motrice nei due sensi della sua rotazione
Funziono Fly-back
Data, giorno della settimana, mese, indicazione della fase lunare
Diametro d'incastatura: 30,00 mm
Altezza totale del movimento: 7,55 mm
Piccola lancetta dei secondi alle nove
Totalizzatore 30 minuti e Totalizzatore 12 ore
Cambiamento istantaneo e simultaneo della data, del giorno della settimana e del mese
Aggiornamento rapido della data: con rotazione della corona in posizione tirata di due livelle (la posizione delle lancette prima della correzione deve essere sotto l'asse virtuale 09:00 - 03:00) - Salto del mese al passaggio dal 31 al 1
Cambiamento rapido del giorno della settimana et dell'indicazione delle fasi lunari con pressioni ripetute sul correttore corrispondente
Riserva di marcia: 50 ore
Frequenza: 36'000 alt/ore
31 Rubini
Angolo di leva del bilanciante: 52°
Racchetta con regolazione di precisione
Bilanciere anulare, spirale autocompensatore

El Primero 4002



PRINCIPALES CARACTÉRISTIQUES

Mouvement à remontage automatique commandé par une roue à colonnes
Remontage bidirectionnel par un rotor central monté sur roulement à billes
Diamètre d'encastrement: 30,00 mm
Hauteur totale du mouvement: 6,50 mm
Aiguille de petite seconde
Totalisateur de 30 minutes
Date: changement instantané
Mise à la date rapide par rotation de la couronne en position tirée de 2 crans
Réserve de marche: 50 heures
Fréquence: 36'000 alt/h
31 rubis
Angle de levée du balancier: 52°
Raquetterie avec réglage fin
Balancier annulaire, spiral autocompensateur

MAIN FEATURES

Self-winding chronograph movement co-ordinated by a column wheel
Bi-directional automatic winding with central ball bearing rotor
Casing diameter: 30.00 mm
Overall height: 6.50 mm
Small second hand
30 minutes recorder
Date: instantaneous change
Rapid date setting: by rotating the crown when it is pulled out two notches
Power reserve: 50 hours
Frequency: 36'000 vib/hr
31 jewels
Lift angle of the balance: 52°
Fine adjustment index-assembly
Annular balance, self-compensating hairspring

HAUPTMERKMALE

Uhrwerk mit automatischem Aufziehen von einem Säulenrad gesteuert
Schwungmasse auf Kugellager montiert, die Zugfeder in den beiden Richtungen ihrer Drehung aufzieht
Gehäusepassungs-Durchmesser: 30.00 mm
Totalhöhe : 6.50 mm
Kleiner Sekundenzeiger auf 9 Uhr
30-Minuten-Zähler
Datum: schnellschaltend
Datumschnellkorrektur durchs Umdrehen der Krone um 2 Kerben herausgezogen
Gangreserve: 50 Stunden
Frequenz: 36'000 Halbschwingungen/St.
31 Rubine
Hebungswinkel der Unruh: 52°
Rückervorrichtung mit Feinregulierung
Unruh mit glattem Reif, selbstkompensierte Spiralfeder.

PRINCIPALI CARATTERISTICHE

Movimento cronografo automatico coordinato dalla ruota a colonna
Massa oscillante montata su cuscinetto a sfere, carica la molla motrice nei due sensi della sua rotazione
Diametro d'incassatura: 30,00 mm
Altezza totale del movimento: 6,50 mm
Piccola lancetta del secondi alle nove
Totalizzatore 30 minuti
Data: cambiamento istantaneo
Cambio istantaneo della data mediante la corona (position tirée de 2 crans)
Riserva di marcia : 50 ore
Frequenza: 36'000 alt/ore
31 Rubini
Angolo di leva del bilanciere: 52°
Racchetta con regolazione di precisione
Bilanciere anulare, spirale autocompensatore

El Primero 4009



PRINCIPALES CARACTÉRISTIQUES

Mouvement à remontage automatique commandé par une roue à colonnes
 Remontage bidirectionnel par un rotor central monté sur roulement à billes
 Fonction « retour de vol » (flyback)
 Indication date, jour de la semaine, mois
 Indication des phases de la lune par une aiguille
 Diamètre d'encadrement: 30,00 mm
 Hauteur totale du mouvement: 7,55 mm
 Aiguille de petite seconde
 Totalisateurs de 30 minutes et de 12 heures
 Date, jour de la semaine et mois: changement simultané et instantané
 Mise à la date rapide: par rotation de la couronne en position tirée de 2 crans (position des aiguilles avant correction doit être sous l'axe virtuel 09:00 - 03:00) - Saut du mois au passage du 31 au 1.
 Changement rapide du jour de la semaine et de l'indication de phases de lune par pressions répétées sur le correcteur correspondant
 Réserve de marche: 50 heures
 Fréquence: 36'000 alt/h
 31 rubis
 Angle de levée du balancier: 52°
 Raquetterie avec réglage fin; balancier annulaire, spiral autocompenseur

MAIN FEATURES

Self-winding chronograph movement co-ordinated by a column wheel
 Bi-directional automatic winding with central ball bearing rotor
 Fly-back function
 Date, day, month window & moonphase indication by hand
 Casing diameter: 30.00 mm
 Overall height: 7.55 mm
 Small second hand
 30 minutes & 12 hours recorders
 Date, day & month; instantaneous & simultaneous change
 Rapid date setting: by rotating the crown when it is pulled out two notches (hands position must be below the virtual axis 9.00 - 03:00 on the dial) - Months change automatically while turning from 31 to 1
 Rapid day & Moonphase setting: by pressing several times the correctors
 Power reserve: 50 hours
 Frequency: 36'000 vib/hr
 31 jewels
 Lift angle of the balance: 52°
 Fine adjustment index-assembly
 Annular balance, self-compensating hairspring

HAUPTMERKMALE

Uhrwerk mit automatischem Aufziehen von einem Säulenrad gesteuert
 Schwungmasse auf Kugellager montiert, die Zugfeder in den beiden Richtungen ihrer Drehung aufzieht
 Fly-back-Funktion
 Datum, Wochentag, Monat
 Anzeige der Mondphase durch einen Zeiger
 Gehäusepassungs-Durchmesser: 30.00 mm
 Totalhöhe: 7.55 mm
 Kleiner Sekundenzeiger auf 9 Uhr
 30-Minuten und 12-Stunden-Zähler
 Simultaner und augenblicklicher Wechsel von Datum, Wochentag und Monat
 Datumschnellkorrektur durchs Umdrehen der Krone um 2 Kerben herausgezogen (Zeigerstellung vor Korrektur unter Virtualachse 09:00 - 03:00) - Bei jedem Datumswechsel von 31 zu 1, dreht sich die Monatsgabe um eine Einheit weiter
 Wochentageinstellung und Mondphasen: Korrektor mehrmals betätigen
 Gangreserve: 50 Stunden
 Frequenz: 36'000 Halbschwingungen/St.
 31 Rubine
 Hebungswinkel der Unruh: 52°
 Rückvorrichtung mit Feinregulierung
 Unruh mit glattem Reif, selbstkompensierte Spiralfeder.

PRINCIPALI CARATTERISTICHE

Movimento cronografo automatico coordinato dalla ruota a colonna
 Massa oscillante montata su cuscinetto a sfere, carica la molla motrice nei due sensi della sua rotazione
 Funzioni Fly-back
 Data, giorno della settimana, mese
 Indicazione della fase lunare par una aiguille
 Diametro d'incassatura: 30,00 mm
 Altezza totale del movimento: 7,55 mm
 Piccola lancetta dei secondi alle nove
 Totalizzatore 30 minuti e totalizzatore 12 ore
 Cambiamento istantaneo e simultaneo della data, del giorno della settimana e del mese
 Aggiornamento rapido della data: con rotazione della corona in posizione tirata di due livelli (la posizione delle lancette prima della correzione deve essere sotto l'asse virtuale 09:00 - 03:00) - Salto del mese al passaggio dal 31 al 1
 Cambiamento rapido del giorno della settimana et dell'indicazione delle fasi lunari con pressioni ripetute sul correttore corrispondente
 Riserva di marcia: 50 ore
 Frequenza: 36'000 alt/ore
 31 Rubini
 Angolo di leva del bilanciere: 52°
 Racchetta con regolazione di precisione
 Bilanciere anulare, spirale autocompenseur

El Primero 4021



PRINCIPALES CARACTÉRISTIQUES

Mouvement à remontage automatique commandé par une roue à colonnes
Remontage bidirectionnel par un rotor central monté sur roulement à billes
Indication de la réserve de marche par une aiguille centrale
Diamètre d'encadrement: 30,00 mm
Hauteur totale du mouvement: 6,50 mm
Aiguille de petite seconde
Totalisateur de 30 minutes
Réserve de marche: 50 heures
Fréquence: 36'000 alt/h
31 rubis
Angle de levée du balancier: 52°
Raquetterie avec réglage fin
Balancier annulaire, spiral autocompensateur

PRINCIPALES CARACTÉRISTIQUES

Self-winding chronograph movement co-ordinated by a column wheel
Bi-directional automatic winding with central ball bearing rotor
Power reserve indication by means of a central hand
Casing diameter: 30.00 mm
Overall height: 6.50 mm
Small second hand
30 minutes recorder
Power reserve: 50 hours
Frequency: 36'000 vib/hr
31 jewels
Lift angle of the balance 52°
Fine adjustment index-assembly
Annular balance, self-compensating hairspring

HAUPTMERKMALE





Uhrwerk mit automatischem Aufziehen von einem Säulenrad gesteuert
Schwungmasse auf Kugellager montiert, die Zugfeder in den beiden Richtungen ihrer Drehung aufzieht
Anzeige der Gangreserve durch einen Zentralzeiger
Gehäusepassungs-Durchmesser: 30.00 mm
Totalhöhe: 6.50 mm
Kleiner Sekundenzeiger auf 9 Uhr
30-Minuten-Zähler
Gangreserve: 50 Stunden
Frequenz: 36'000 Halbschwingungen/St.
31 Rubine
Hebungswinkel der Unruh: 52°
Rückervorrichtung mit Feinregulierung
Unruh mit glattem Reif, selbstkompensierte Spiralfeder.

PRINCIPALI CARATTERISTICHE

Movimento cronografo automatico coordinato dalla ruota a colonna
Massa oscillante montata su cuscinetto a sfere, carica la molla motrice nei due sensi della sua rotazione
Indicatore della riserva di marcia
Diametro d'incassatura: 30,00 mm
Altezza totale del movimento: 6,50 mm
Piccola lancetta del secondi alle nove
Totalizzatore 30 minuti
Riserva di marcia: 50 ore
Fréquence: 36'000 alt/ore
31 Rubini
Angolo di leva del bilanciere: 52°
Racchetta con regolazione di precisione
Bilanciere anulare, spirale autocompensatore

400

EL PRIMERO



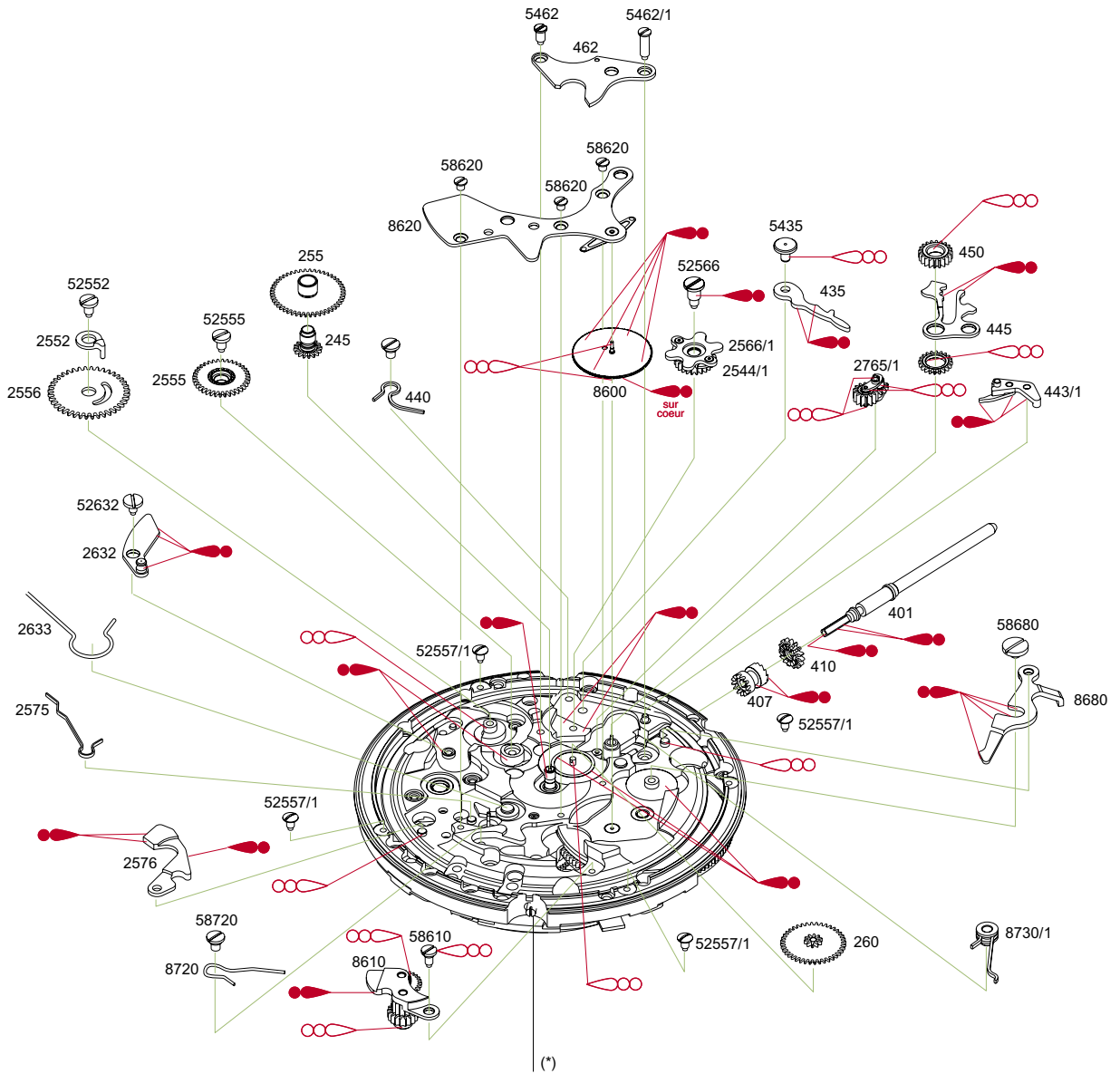
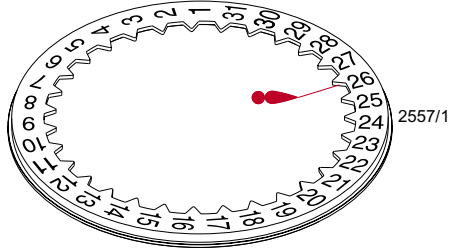



-  MOEBIUS 9010
-  JISMAA 124
-  MOEBIUS D5
-  MOEBIUS 9415
-  KT 22



(*) FREIN FILET / LOCK THREAD / GEWINDESICHERUNG / FRENORETE

400

EL PRIMERO

-  MOEBIUS 9010
-  JISMAA 124
-  MOEBIUS D5
-  MOEBIUS 9415
-  KT 22
-  Prélubrification
Vergölt
Pre oiled

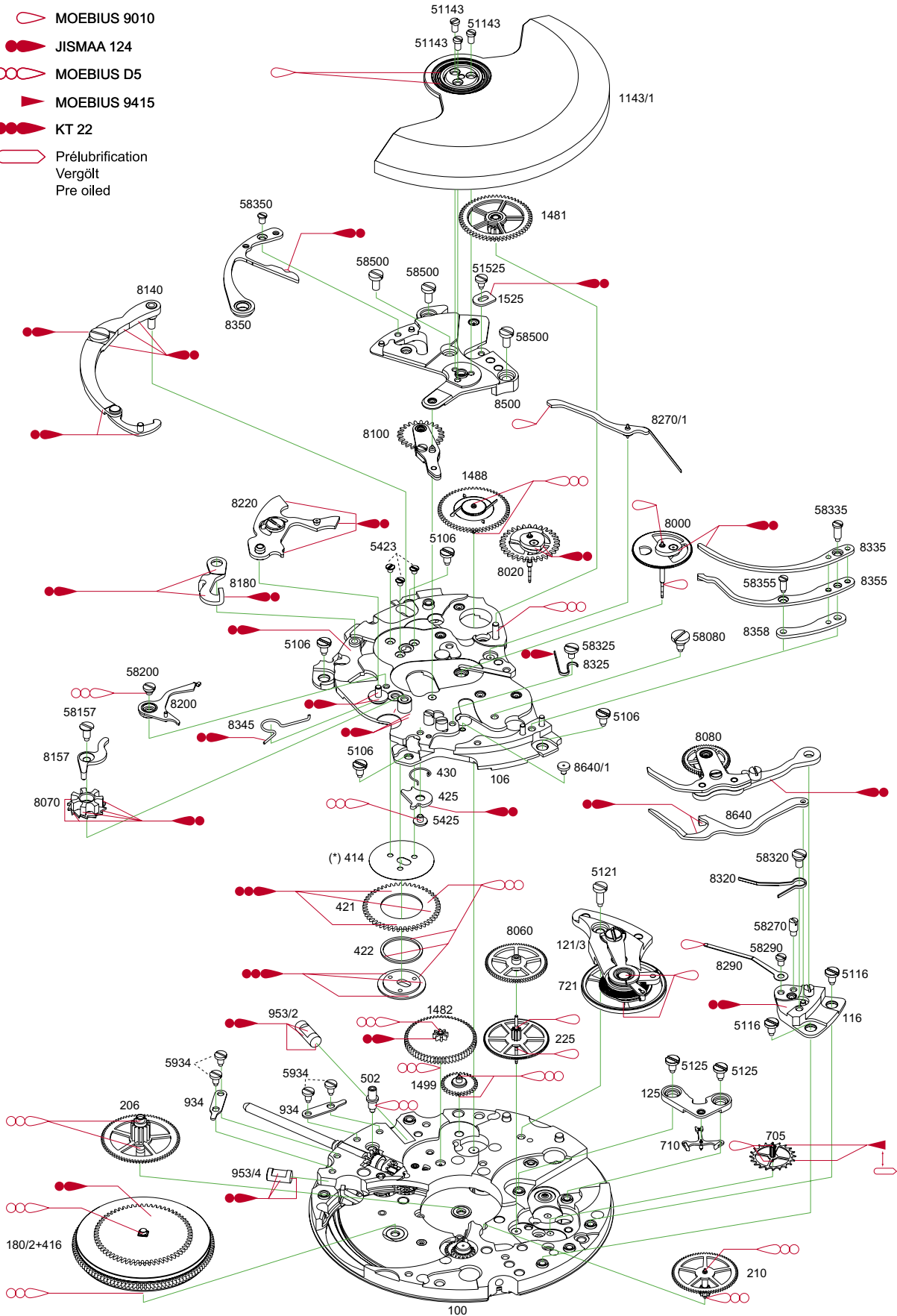

(*) SELON MODÈLE DE PONT DE ROUAGE

405 FLY BACK

Specific parts for the Flyback device

Some parts have been technically modified on the calibre El Primero with the Flyback device as followed:

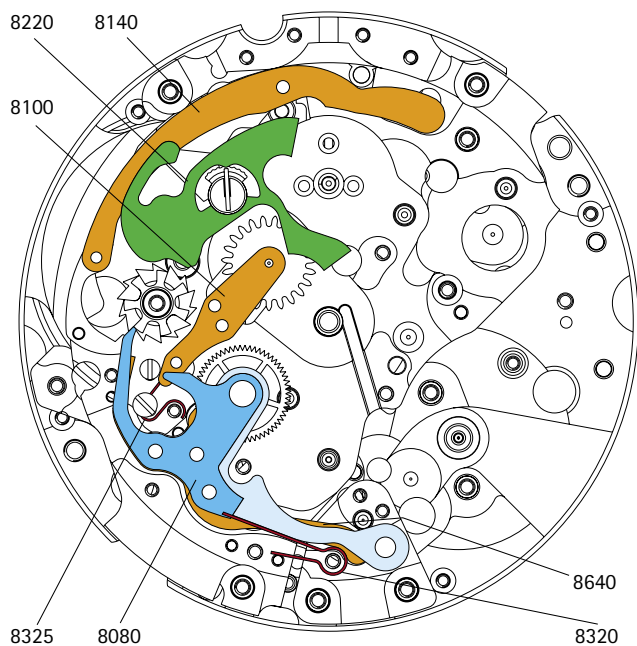

Coupling clutch, mounted (8080) Operating lever(8140)
Coupling clutch spring (8320) Hammer (8220)
Sliding gears (8100)
Switch (8640)
Sliding gear spring (8325)

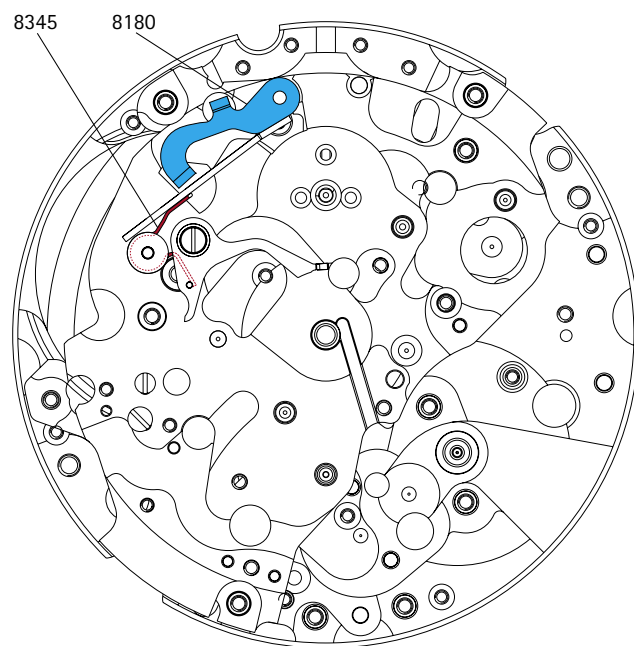

Blocking lever spring (8345)
Flyback lever (8180)

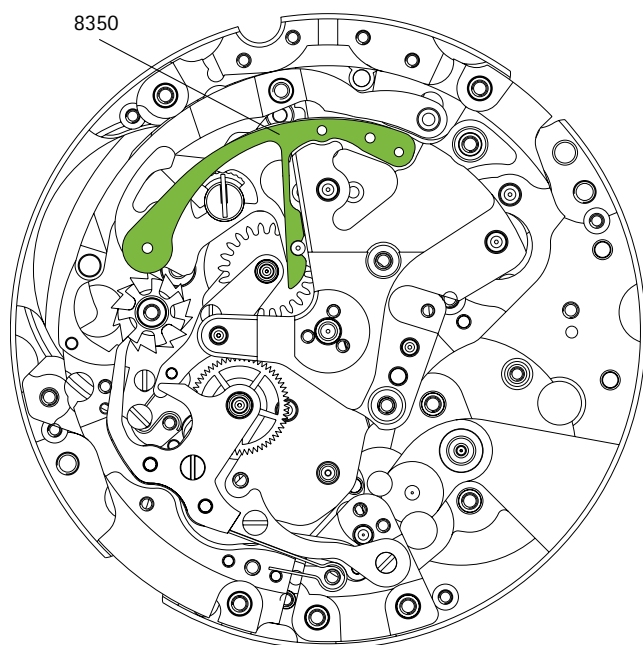



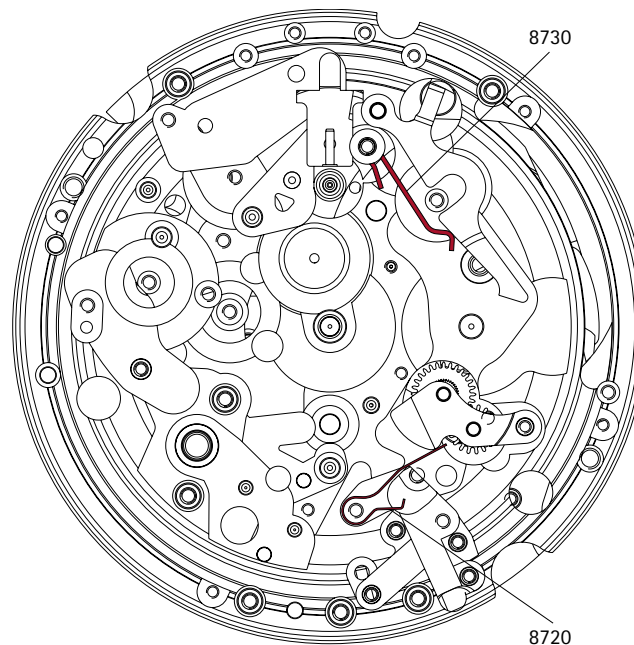

Hammer spring (8350)



Conveyor spring (8720)
Hour hammer spring (8730)

410

EL PRIMERO

-  MOEBIUS 9010
-  JISMAA 124
-  MOEBIUS D5
-  MOEBIUS 9415
-  KT 22



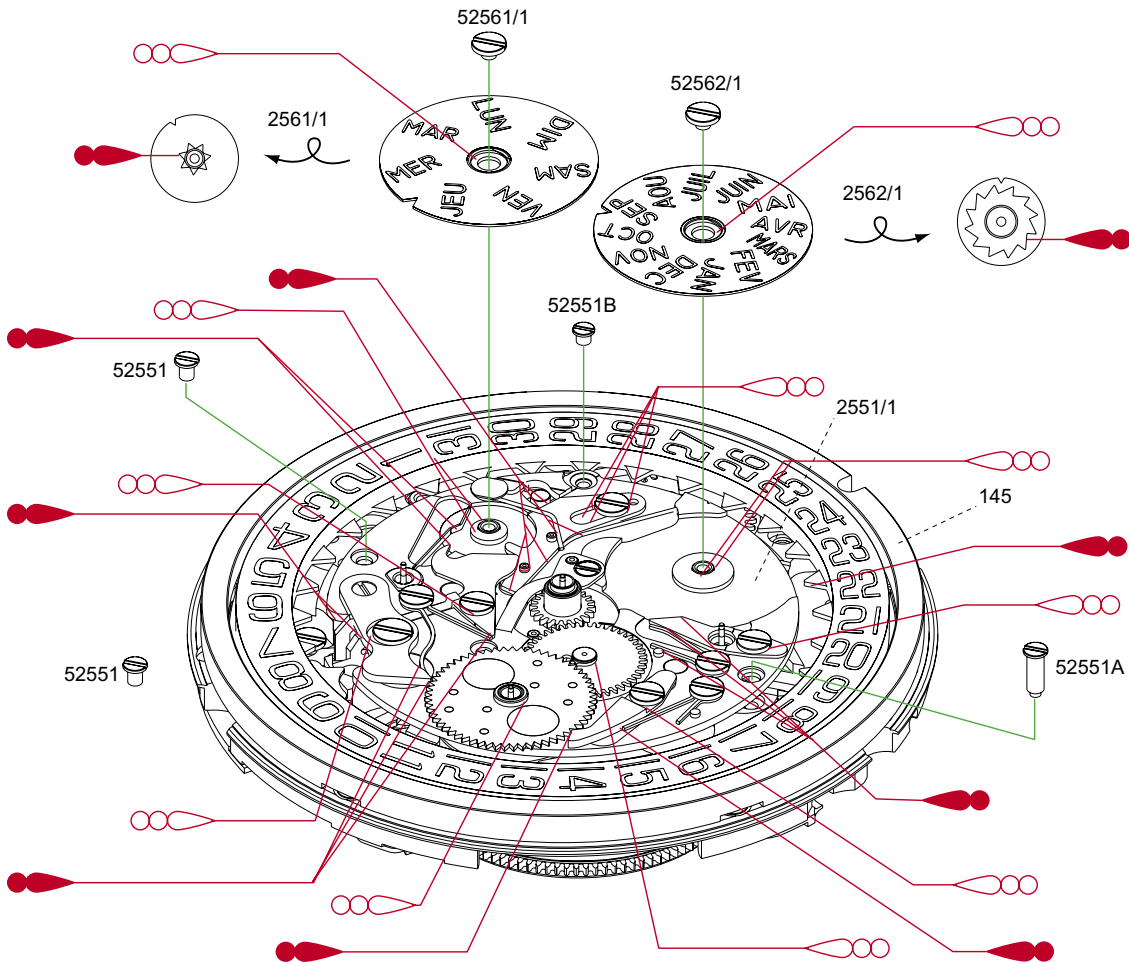

ORDRE DE DEMONTAGE
 DEMONTAGE - REIHENFOLGE
 ORDER OF DISASSEMBLING
 ORDINE DI SMONTAGGIO

- 2551/1
- 52551 X 2
- 52551A
- 52551B
- 2561/1
- 52561/1
- 2562/1
- 52562/1
- 145



410

EL PRIMERO

-  MOEBIUS 9010
-  JISMAA 124
-  MOEBIUS D5
-  MOEBIUS 9415
-  KT 22

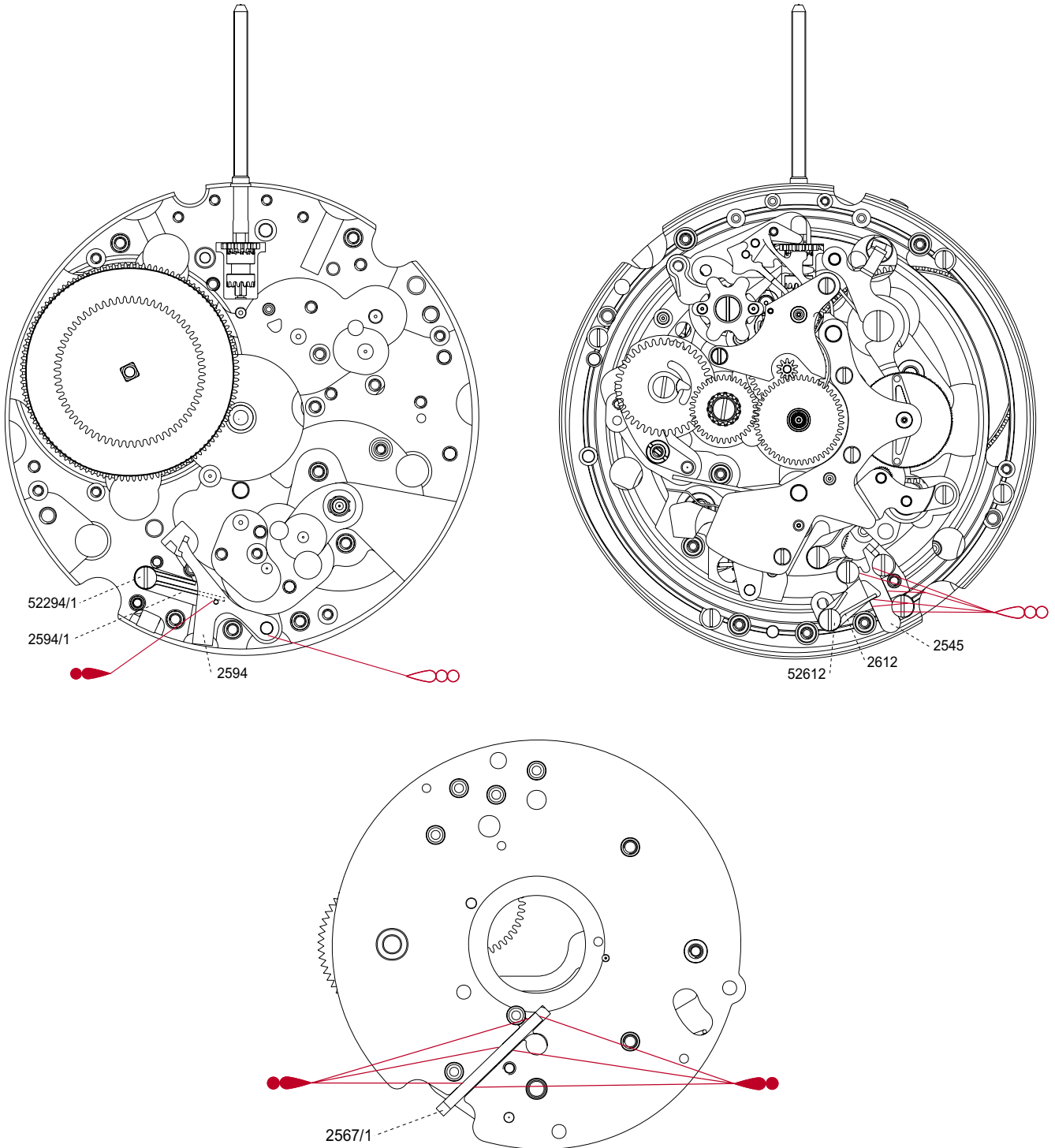

TECHNICAL SPECIFICATIONS

400-405-410-420 & 400Z-405Z-410Z-420Z

400-405-410-420

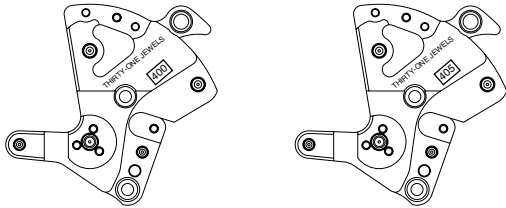

N° SAV : 8500

400Z-405Z-410Z-420Z

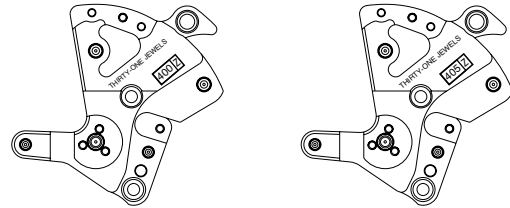

N° SAV : 8500Z

Chronograph
bridge

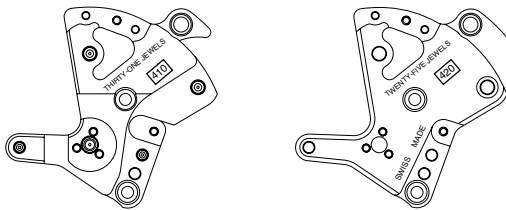

N° SAV : 225
53.74.0110.400

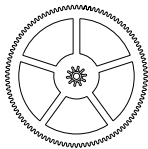

100 teeth / 5 arms

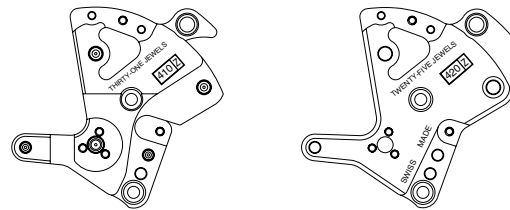

N° SAV : 225Z
53.74.0390.400

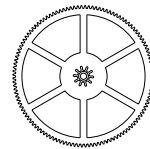

120 teeth / 6 arms

Fourth
wheel

N° SAV : 705
53.76.0160.400

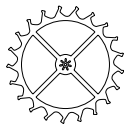

Wheel with 21 teeth / Pinion with 7 teeth

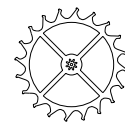

N° SAV : 705Z
53.76.0390.400

Wheel with 20 teeth / Pinion with 8 teeth

Escape
wheel

N° SAV : 710
54.79.0090.400

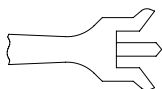

Shape of the horns

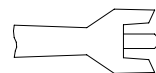





N° SAV : 710Z
54.79.0260.400

Shape of the horns

Pallet fork

4021

RÉSERVE DE MARCHE

-  MOEBIUS 9010
-  JISMAA 124
-  MOEBIUS D5
-  MOEBIUS 9415
-  KT 22

ORDRE DE DEMONTAGE
 DEMONTAGE - REIHENFOLGE
 ORDER OF DISASSEMBLING
 ORDINE DI SMONTAGGIO

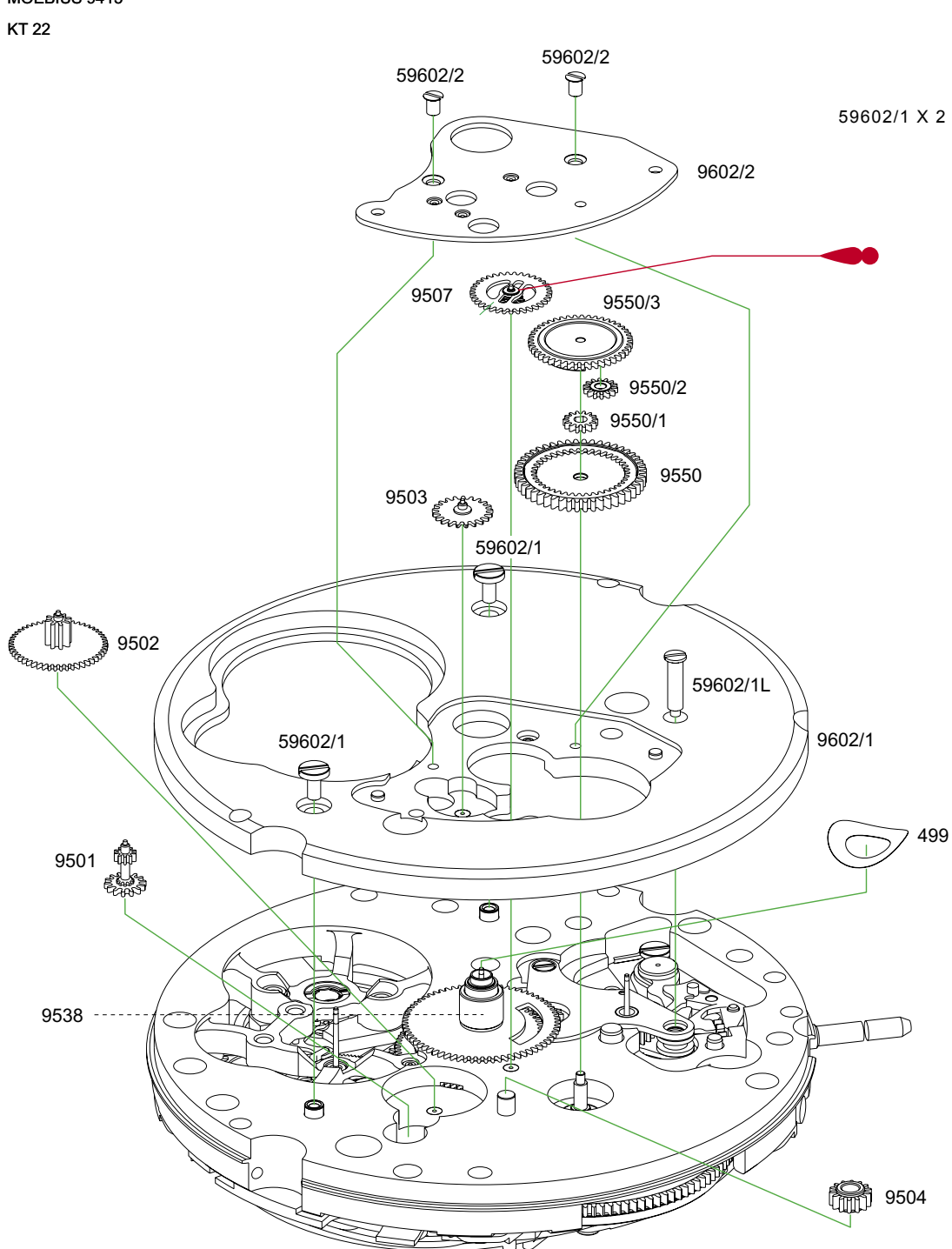

- 9501
- 9502
- 9538
- 499
- 9602/1
- 59602/1 X 2 + 59602/1L X 1
- 9550
- 9550/1
- 9550/2
- 9550/3
- 9503
- 9504
- 9507
- 9602/2
- 59602/2 X 2

4021

RÉSERVE DE MARCHE

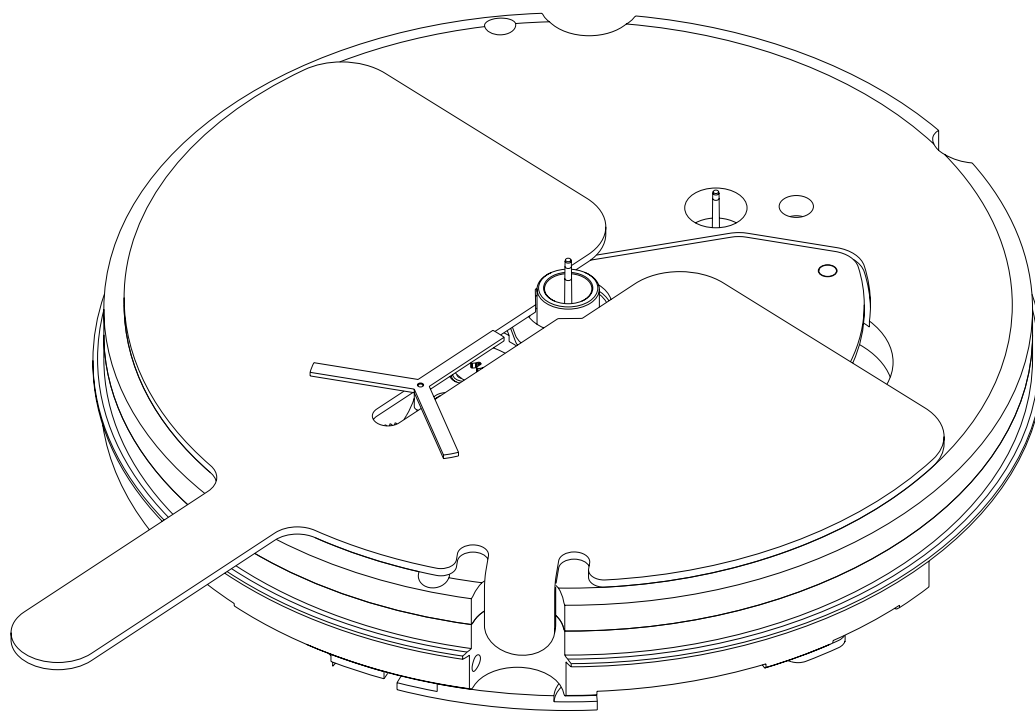

Movement / Mouvement / Werk / Movimento

PARTS No	CALIBRE EL PRIMERO								PARTS No	CALIBRE EL PRIMERO							
	400z	405z	410z	420 z	4001	4002	4009	4021		400z	405z	410z	420 z	4001	4002	4009	4021
100	1	1							255	1	1						
100			1(*)						255								1
100				1					260	1	1	1	1	1	1	1	1
100					1		1		380	1	1	1	1	1	1	1	1
100						1			381	1	1	1	1	1	1	1	1
100								1	401	1	1	1	1	1	1	1	1
106	1	1	1						407	1	1	1	1	1	1	1	1
106			1		1	1	1		410	1	1	1	1	1	1	1	1
106				1					414	1	1	1	1	1	1	1	1
106								1	421	1	1	1	1	1	1	1	1
116	1	1	1	1					422	1	1	1	1	1	1	1	1
116			1		1	1	1		423	1	1	1	1	1	1	1	1
116								1	425	1	1	1	1	1	1	1	1
121/3	1	1	1(*)	1					430	1	1	1	1	1	1	1	1
121/3			1		1	1	1		435	1	1	1	1	1	1	1	1
121/3								1	435								1
125	1	1	1	1					440	1	1	1	1	1	1	1	1
125			1		1	1	1		443/1	1	1	1	1	1	1	1	1
125								1	443								1
145	1	1		1					445	1	1	1	1	1	1	1	1
145			1		1		1		450	1	1	1	1	1	1	1	1
166	2	2	2	2	2	2	2	2	451	1	1	1	1	1	1	1	1
180/1 + 416				1					462	1	1	1	1	1		1	
180/2 + 416	1	1	1		1	1	1		462			1		1			1
180/2 + 416								1	499	1	1		1	1	1		
206	1	1	1	1	1	1	1	1	499								1
210	1	1	1	1	1	1	1	1	502	1	1	1	1	1	1	1	1
225	1	1	1	1	1	1			705	1	1	1	1	1	1	1	1
225							1		710	1	1	1	1	1	1	1	1
225								1	721	1	1	1	1	1	1	1	1
245	1	1		1		1			934	1	1	1	1	1	1	1	1
245			1		1				953/2	1	1	1	1	1	1	1	1
245							1		953/4	1	1	1	1	1	1	1	1
245								1	1143/1	*	*	*		*	*	*	*

Screws of mvt / Visserie mvt / Schraubenwerk / Viti del mov

PARTS No	CALIBRE EL PRIMERO								PARTS No	CALIBRE EL PRIMERO							
	400z	405z	410z	420 z	4001	4002	4009	4021		400z	405z	410z	420 z	4001	4002	4009	4021
5106	4	4	4	4	4	4	4	4	5125 (*)			2		2	2	2	2
5106 (*)			4		4	4	4	4	5121	1	1	1	1				
5116	2	2	2	2	2	2	2	2	5121 (*)			1		1	1	1	1
5116 (*)			2		2	2	2	2	5166	2	2	2	2	2	2	2	2
5125	2	2	2	2	2	2	2	2	5423	3	3	3	3				

* = variety / variété / Varianten / varietà (see new habillage code) (*) = Aesthetic difference only / Terminaison différente/ verschiedene Ausführungen / Rifinitura diversa

INTERCHANGEABILITE / INTERCHANGEABILITY
AUSWECHSELBARKEIT / INTERCAMBIABILITA

Screws of mvt / Visserie mvt / Schraubenwerk / Viti del mov

PARTS No	CALIBRE EL PRIMERO							
	400z	405z	410z	420z	4001	4002	4009	4021
5423			3		3	3	3	3
5425	1	1	1	1				
5425			1		1	1	1	1
5440	1	1	1	1	1	1	1	1
5462	1	1	1	1	1	1	1	1
5462/1	1	1		1		1		1

PARTS No	CALIBRE EL PRIMERO							
	400z	405z	410z	420z	4001	4002	4009	4021
5750	1	1	1	1	1	1	1	
5750 (/1)			1		1		1	1
5750 (/8)			1		1		1	
5934	4	4	4	4				
5934*			4		4	4	4	4

Auto. winding Et calendar / Remontage auto Et quantième / Aut. Aufzug. u. Kalender / Ricarica auto e calendario

PARTS No	CALIBRE EL PRIMERO							
	400z	405z	410z	420z	4001	4002	4009	4021
1481	1	1	1		1	1	1	1
1482	1	1	1		1	1	1	1
1488	1	1	1		1	1	1	1
1499	1	1	1		1	1	1	1
1525	1	1	1		1	1	1	1
2544/1	1	1	1	1	1	1	1	
2552	1	1	1	1	1	1	1	
2555	1	1	1	1	1	1	1	
2556	1	1	1	1	1	1	1	

PARTS No	CALIBRE EL PRIMERO							
	400z	405z	410z	420z	4001	4002	4009	4021
2557/1	*	*	*	*	*	*	*	
2558			1		1			
2558								1
2566/1	1	1	1	1	1	1	1	1
2575	1	1	1	1	1	1	1	1
2576	1	1	1	1	1	1	1	1
2632	1	1		1		1		
2633	1	1	1	1	1	1	1	1
2765/1	1	1	1	1	1	1	1	1

Screws of auto winding and calendar / Visserie remontage auto Et quantième / Schrauben für aut. Aufzug u. Kalender / Viti della ricarica auto e calendario

PARTS No	CALIBRE EL PRIMERO							
	400z	405z	410z	420z	4001	4002	4009	4021
51143	3	3	3					
51143 (*)			3		3	3	3	3
51525	1	1	1	1				
51525*			1		1	1	1	1
52552/55	1	1	1	1	1	1	1	

PARTS No	CALIBRE EL PRIMERO							
	400z	405z	410z	420z	4001	4002	4009	4021
52552/55			1		1	1	1	
52557/1	4	4	4	4	4	4	4	
52566	1	1	1	1	1	1	1	1
52632	1	1	1	1	1	1	1	

Chronograph mechanism/ Mécanisme de Chronographe / Chronograph Mechanismus / Meccanismo del cronografo

PARTS No	CALIBRE EL PRIMERO							
	400z	405z	410z	420z	4001	4002	4009	4021
8000	1	1		1		1		
8000			1		1			
8000							1	
8000								1
8020	1	1		1		1		
8020			1		1			
8020							1	
8020								1

PARTS No	CALIBRE EL PRIMERO							
	400z	405z	410z	420z	4001	4002	4009	4021
8060	1	1	1	1	1	1	1	1
8070	1	1	1	1	1	1	1	1
8080	1		1	1				
8080		1						
8080*			1			1		
8080					1		1	
8080								1
8100	1		1	1				

* = variety / variété / Varianten / varietà (see new habillage code) (*) = Aesthetic difference only / Terminaison différente/ verschiedene Ausführungen / Rifinitura diversa

Chronograph mechanism/ Mécanisme de Chronographe / Chronograph Mechanismus / Meccanismo del cronografo

PARTS No	CALIBRE EL PRIMERO								PARTS No	CALIBRE EL PRIMERO							
	400z	405z	410z	420 Z	4001	4002	4009	4021		400z	405z	410z	420 Z	4001	4002	4009	4021
8100		1							8350		1			1		1	
8100*			1			1		1	8350						1		
8100					1		1		8350								1
8140	1		1	1					8355	1	1	1	1	1	1	1	
8140		1							8355								1
8140*			1			1			8358	1	1	1	1	1	1	1	1
8140					1		1		8500	1							
8140								1	8500		1						
8157	1	1	1	1					8500			1(*)					
8157*			1		1	1	1		8500			1					
8157								1	8500				1				
8180	1		1	1		1		1	8500					1			
8180		1			1		1		8500						1		
8200	1	1	1	1	1	1	1		8500						1		
8200								1	8500								1
8220	1		1	1					8600	1	1		1				
8220		1							8600			1		1			
8220*			1			1			8600						1		
8220					1		1		8600								1
8220								1	8610	1	1	1	1	1		1	
8270/1	1	1	1	1	1	1	1	1	8620	1	1	1	1	1		1	
8290	1	1	1	1	1	1	1	1	8640	1		1	1				
8320	1		1	1		1		1	8640	1		1	1				
8320		1			1		1		8640		1			1		1	
8325	1		1	1		1		1	8640/1	1	1	1	1	1	1	1	1
8325		1			1		1		8680	1	1	1	1	1		1	
8335	1	1	1	1					8720	1		1	1				
8335*			1		1	1	1		8720		1						
8335								1	8720					1		1	
8345	1		1	1		1		1	8730/1	1		1	1				
8345		1			1		1		8730/1		1			1		1	
8350	1		1	1													

Screws of chrono mechanism / Visserie du mech. Chrono / Schrauben für Chronograph Mechanismus
Viti del meccanismo del cronografo

PARTS No	CALIBRE EL PRIMERO								PARTS No	CALIBRE EL PRIMERO							
	400z	405z	410z	420 Z	4001	4002	4009	4021		400z	405z	410z	420 Z	4001	4002	4009	4021
58080	1	1	1	1					58200 (*)			1		1	1	1	1
58080*			1		1	1	1	1	58270	1	1	1	1				
58140	1	1	1	1					58270*			1		1	1	1	1
58140 *			1		1	1	1	1	58290	1	1		1				
58157	1	1	1	1					58290 (*)			1		1	1	1	1
58157*			1		1	1	1	1	58320	1	1	1	1				
58200	1	1	1	1					58320*			1		1	1	1	1

* = variety / variété / Varianten / varietà (see new habillage code) (*) = Aesthetic difference only / Terminaison différente/ verschiedene Ausführungen / Rifinitura diversa

Screws of chrono mechanism / Visserie du mech. Chrono / Schrauben für Chronograph Mechanismus
Viti del meccanismo del cronografo

PARTS No	CALIBRE EL PRIMERO								PARTS No	CALIBRE EL PRIMERO							
	400z	405z	410z	420z	4001	4002	4009	4021		400z	405z	410z	420z	4001	4002	4009	4021
58325	1	1	1	1					58355*			1		1	1	1	
58325*			1		1	1	1	1	58500	3	3	3	3				
58335	1	1	1	1					58500*			3		3	3	3	3
58335*			1		1	1	1	1	58610	1	1	1	1	1	1	1	
58350	1	1	1	1					58620	2	2	2	2	2	2	2	
58350*			1		1	1	1	1	58680	1	1	1	1	1		1	
58355	1	1	1	1					58720	1	1	1	1	1		1	1

Complete calendar + moonphase module / Module triple quantième + phase de lune
Kalender komplet + Mondphasen /Modulo triplo calendario perpetuo + fasi lunari

PARTS No	CALIBRE EL PRIMERO								PARTS No	CALIBRE EL PRIMERO							
	400z	405z	410z	420z	4001	4002	4009	4021		400z	405z	410z	420z	4001	4002	4009	4021
2545			1		1		1		52551			2		2		2	
2551/1			1		1				52551A			1		1		1	
2551/1								1	52551B			1		1		1	
2561/1			*		*		*		52561/1(*)			1		1		1	
2562/1			*		*		*		52562/1(*)			1		1		1	
2567/1			1		1		1		52594 (*)			1		1		1	
2587/1			1		1				52594/1			1		1		1	
2587/1								1	52545A			1		1		1	
2594/1			1		1		1										

Power reserve indicator / Indicateur de réserve de marche / Gangreserve Anzeiger / Indicatore di riserva di marcia

PARTS No	CALIBRE EL PRIMERO				
	655	685	4021		
9550	1	1	1		
9550/1	1	1	1		
9550/2	1	1	1		
9550/3	1	1	1		

* = variety / variété / Varianten / varietà (see new habillage code) (*) = Aesthetic difference only / Terminaison différente/ verschiedene Ausführungen / Rifinitura diversa

SPARE PART AVAILABILITY ON CALIBERS 40.0 & 41.0

Some changes have been made in the availability of movements parts in accordance with the new spare parts chart of those calibers

PARTS NUMBER	NOT SOLD SEPARATELY	SOLD MOUNTED
121/3		X
300/2	X	
301	X	
358	X	
364	X	
5738	X	
8730	X	
445/1	X	
106(*)		X
116(*)		X
8400	X	
8401	X	
8406	X	
180/2+416		X
416	X	
2551/1		X
2587/1 for 410 & 4001	X	
52590A	X	

(*) with its eccentrics

ON CAL 400-410

380 (Ultraflex Kif upper); Exceptionally sold separately (not shown on spare parts chart)
 381 (Ultraflex Kif lower); Exceptionally sold separately (not shown on spare parts chart)
 Parts 2557/1, 2561/1 and 2562/1 need to be defined in «ZHD» code for order
 (see CD-Rom «Spare parts catalog»)
 For Part 145, the type of dial (flat or domed) need to be defined for order.

ON CAL 3019

324 (Incabloc upper); Exceptionally sold separately
 325 (Incabloc lower); Exceptionally sold separately
 58070 is no more available and replace by 8157 + its screw 58157

CALENDAR/MOONPHASE PLATE ON THE ZENITH EL PRIMERO CHRONOMASTER LINE

CALIBRE 410-4001-4009

PARTS NUMBER NOT SOLD SEPARATELY

2551	2632/2
2554	52554
2564	52564
2567	52567
2571/2593	52571/52593
2578	52578
2583	52583
2588	52588
2590	52590
2592	52590A
2612	52592v

NOTICE

The caliber 4009 is equipped with a moonphase hand. Find below the only movement part modified on this module for the calibre 4009 to fit its Moon age hand. The calendar/moonphase module and its components remain the same for the 3 different calibres.

MOON PHASES STAR (WITHOUT DIAL DISC)

4009 - 2587/1

400z

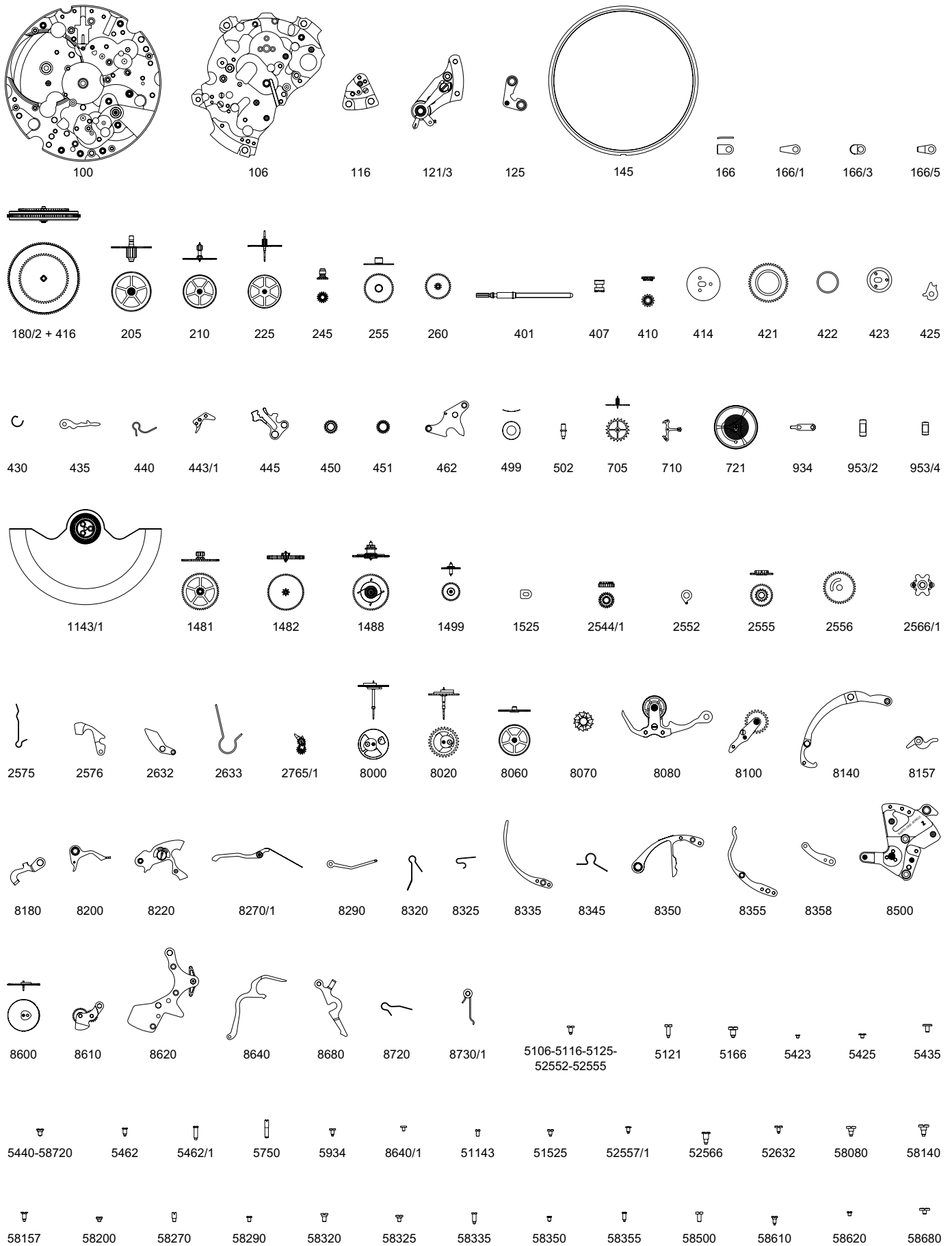

410z

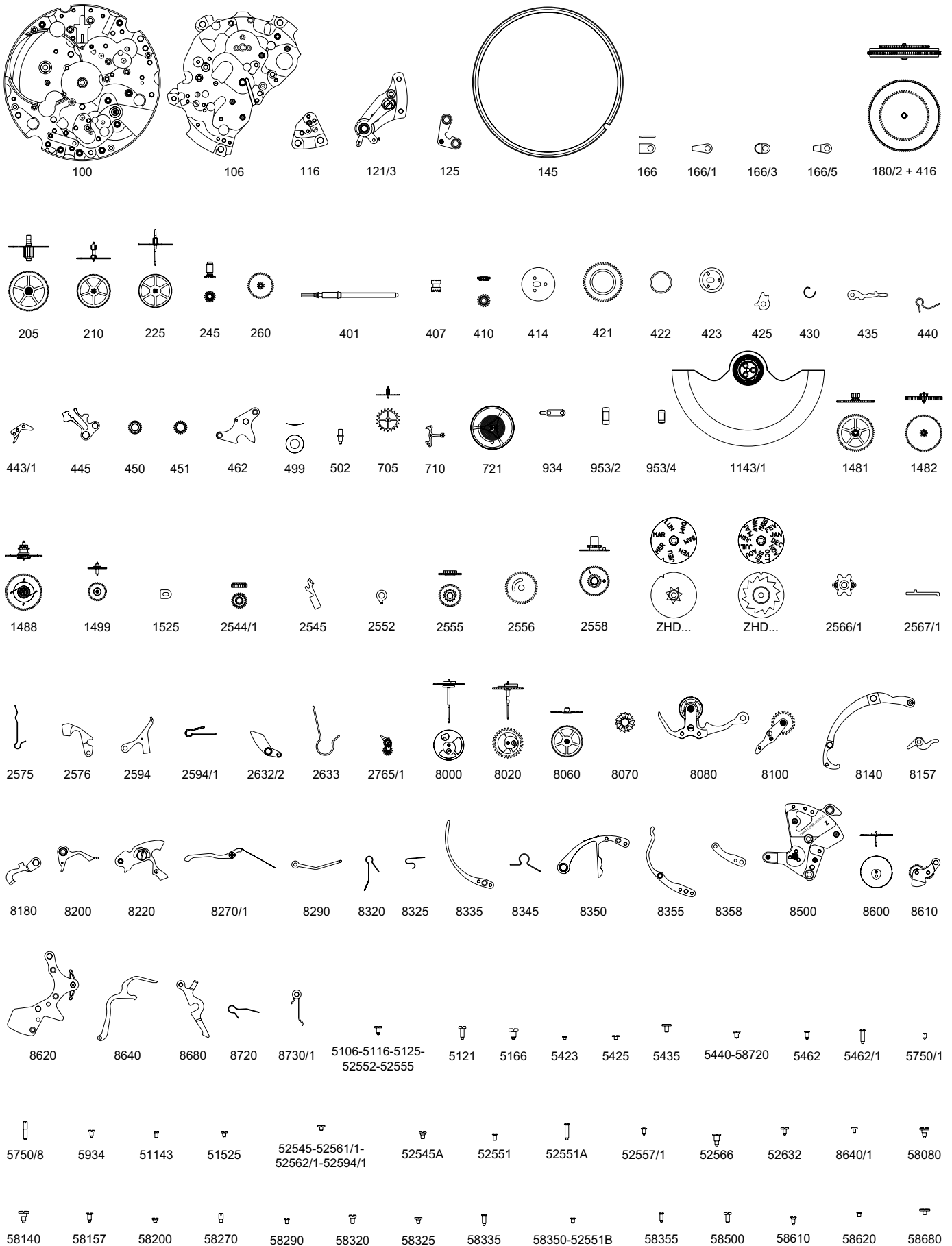

4001

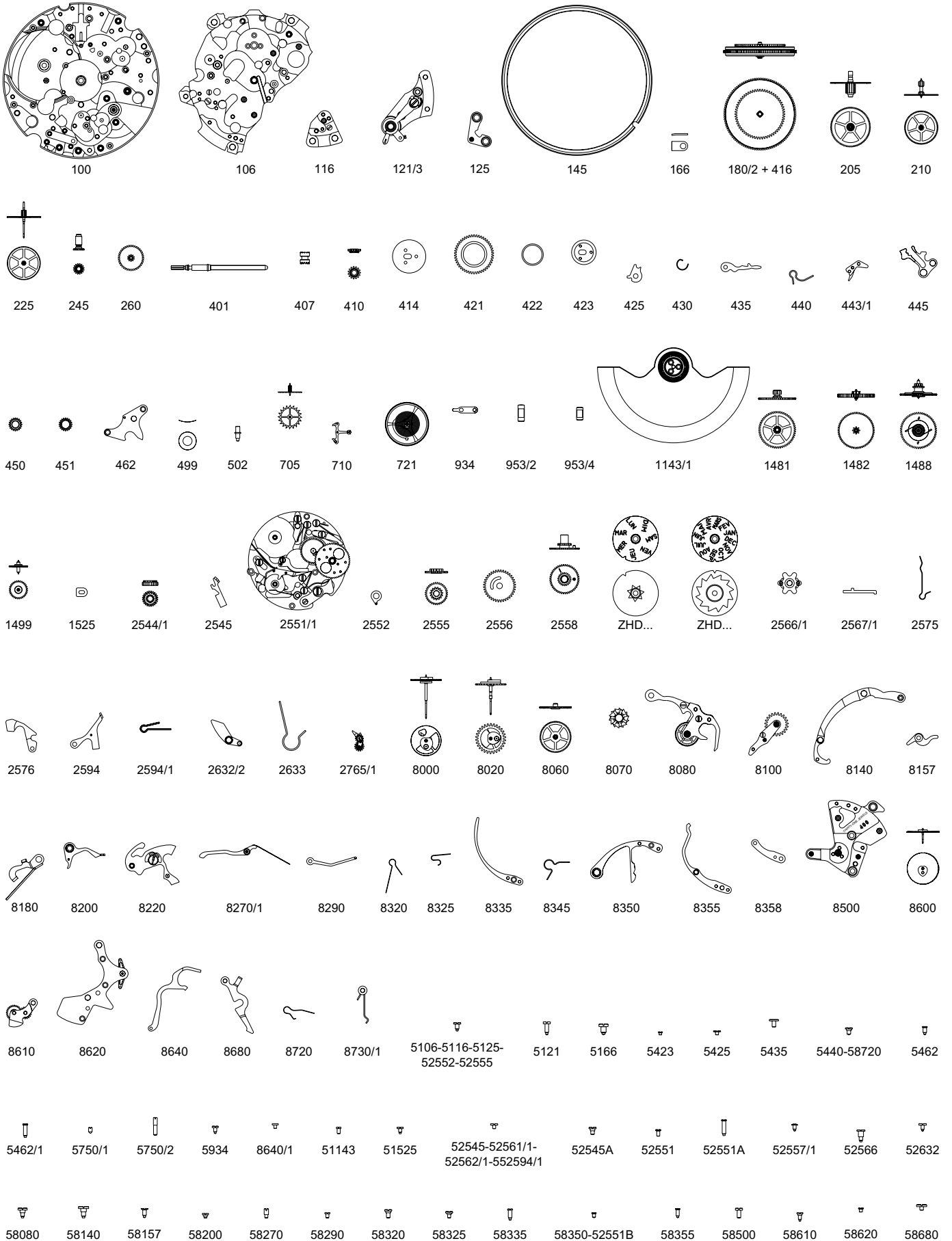

4002

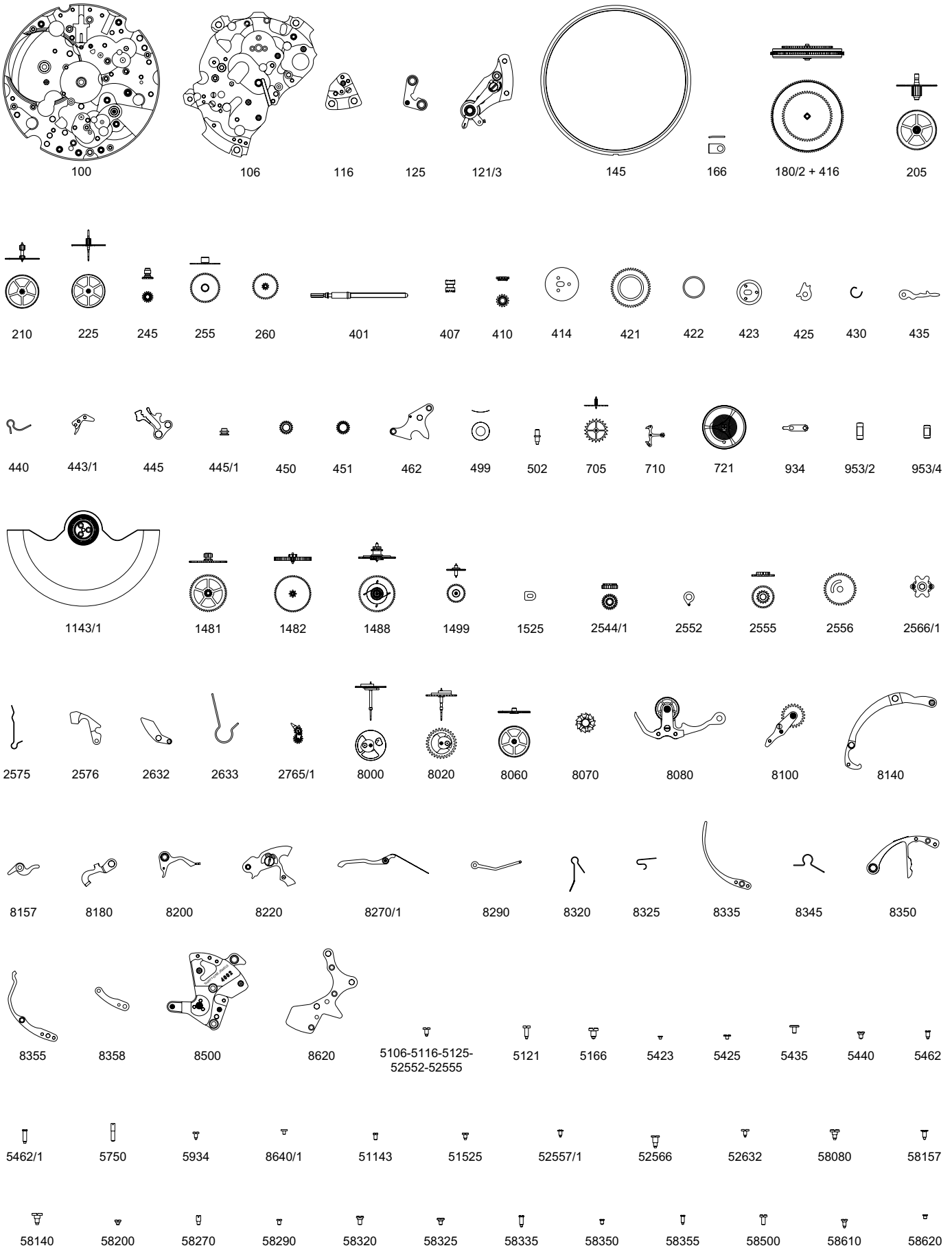

4009

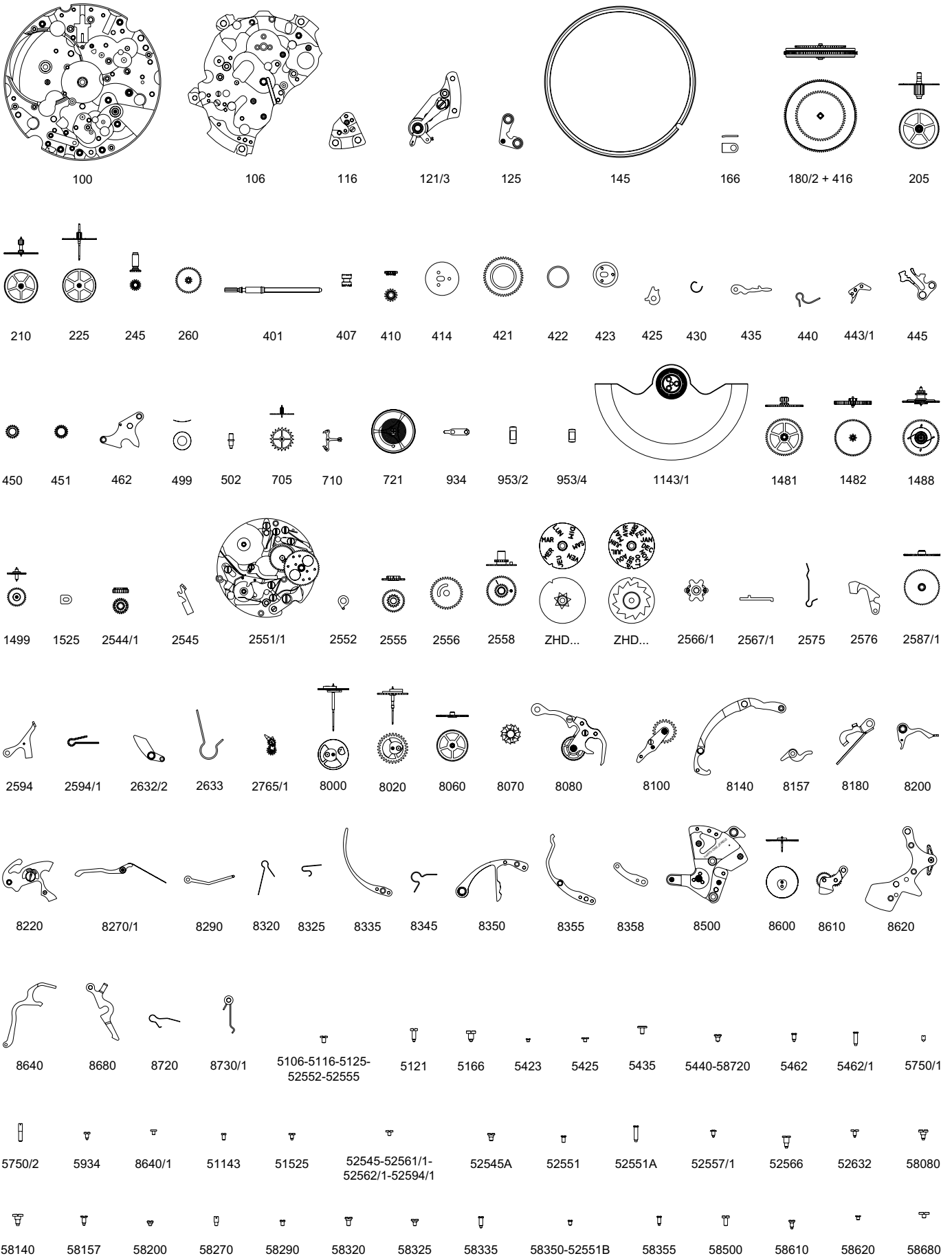

4021

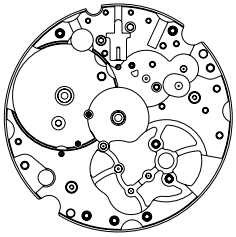

100

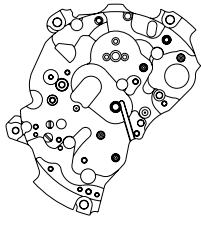

106



116



121/3



125



166

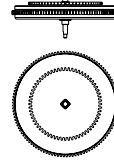

180/2 + 416



205



210



225



245



255



260



292

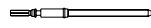

401



407



410



414



421



422



423



425



430



435



440



443



445



445/1



450



451



462



499



502



705



710



721



934



953/2



953/4

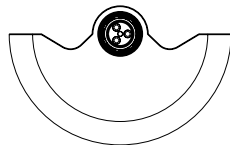

1143/1



1481



1482



1488



1499



1525



8000



8020



8060



8070



8080



8100



8140



8157



8180



8200



8220



8270/1



8290



8320



8325



8335



8345

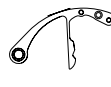

8350



8355



8358

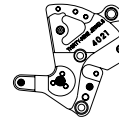

8500



9501



9502



9503



9504



9507



9538



9550



9550/1



9550/2



9550/3

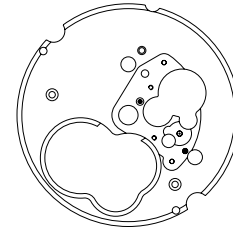

9602/1

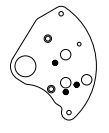

9602/2



5106/5116
5125



5121



5166



5423



5425



5435



5440



5462



5750



5934



51143



51525



58080



58140



58157



58200



58270



58290



58320



58325



58335



58350



58355



58500



59602/1



59602/1L



59602/2