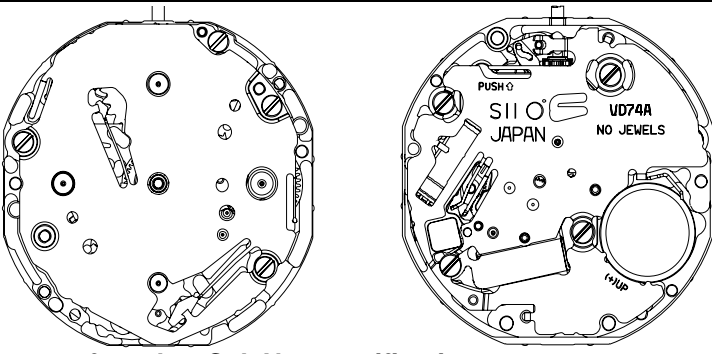

TECHNICAL GUIDE
&
PARTS CATALOGUE

Cal.VD7Series
(VD72/73/74/75/76/77/78/79A)

ANALOGUE QUARTZ

VD7Series

Item		Cal. No.	VD74A						
Movement		 <p>*Refer to the 2pages for other Cal. No. specifications.</p>							
Movement size	Outside diameter	φ23.70 mm 22.60 mm : between 12 o'clock and 6 o'clock sides 22.60 mm : between 3 o'clock and 9 o'clock sides							
	Casing diameter	φ23.30 mm 22.10 mm : between 12 o'clock and 6 o'clock sides 21.40 mm : between 3 o'clock and 9 o'clock sides							
	Total height	3.45 mm							
Time indication	Cal. No.	VD72A	VD73A	VD74A	VD75A	VD76A	VD77A	VD78A	VD79A
	hands	3	4	6	5	5	4	3	4
	2Hands (hour , minute)	O	O	O	O	O	O	O	O
	Small Second hand (6H)	x	O	O	O	O	O	O	x
	24Hour hand (12H)	x	x	O	x	x	O	x	x
	Date -Calendar Hand (3H)	x	x	O	O	x	x	x	O
	Date -Calendar Hand (2H)	O	O	x	x	O	x	x	x
	Day -Calendar Hand (9H)	x	x	O	O	x	x	x	O
Day -Calendar Hand (10H)	x	x	x	x	O	x	x	x	
Driving System	Step motor								
Additional mechanism	Electronic circuit reset switch Second setting device Date setting								
Antimagnetic	≥ 1600 A/m								
Accuracy	Less than ±20seconds : Monthly rate at normal temperature range								
Battery	SR626SW (Silver oxide battery) Battery life is approximately 3 years								
Measuring gate by quartz tester	Use 10-second gate * Set the winding stem with crown at the normal position								
Jewels	0 Jewel								

*** All specifications are subject to change without notice.**

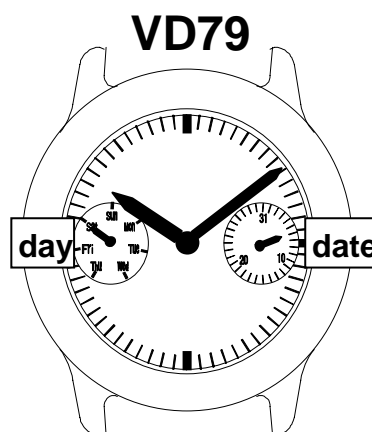
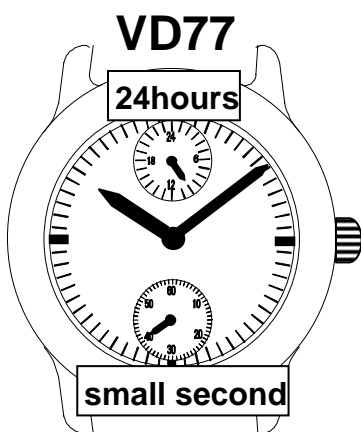
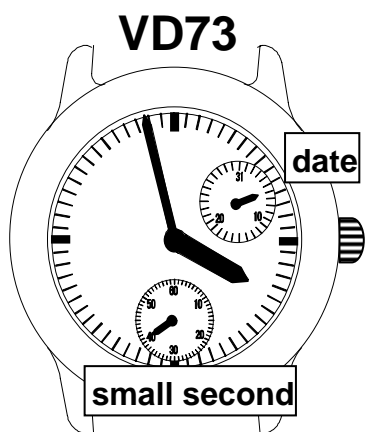
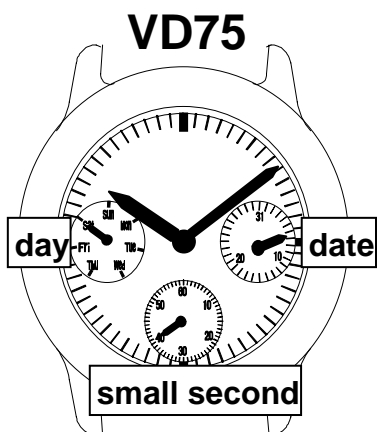

Disassembling procedures Figs. ① ⇒ ⑭

① ⇒ ⑭

Reassembling procedures Figs. ⑭ ⇒ ①

⑭ ⇒ ①

Lubricating : Types of oil

Oil quantity

●▶ Moebius A





Normal quantity

■▶ Moebius F

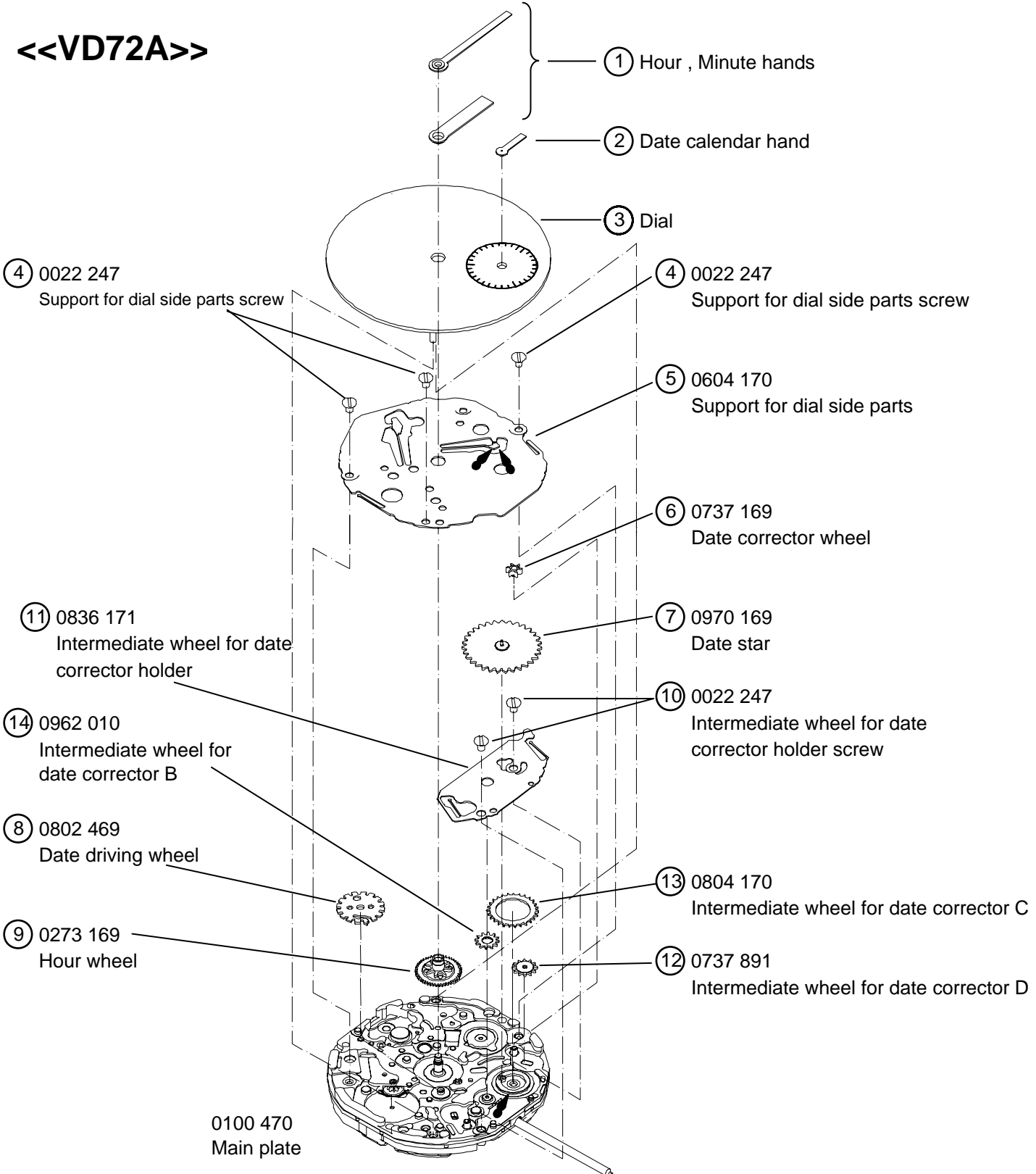
<<VD72A>>





Disassembling procedures Figs. (1) ⇒ (16)
Reassembling procedures Figs. (16) ⇒ (1)

Lubricating : Types of oil Oil quantity
 Moebius A  Normal quantity
 Moebius F

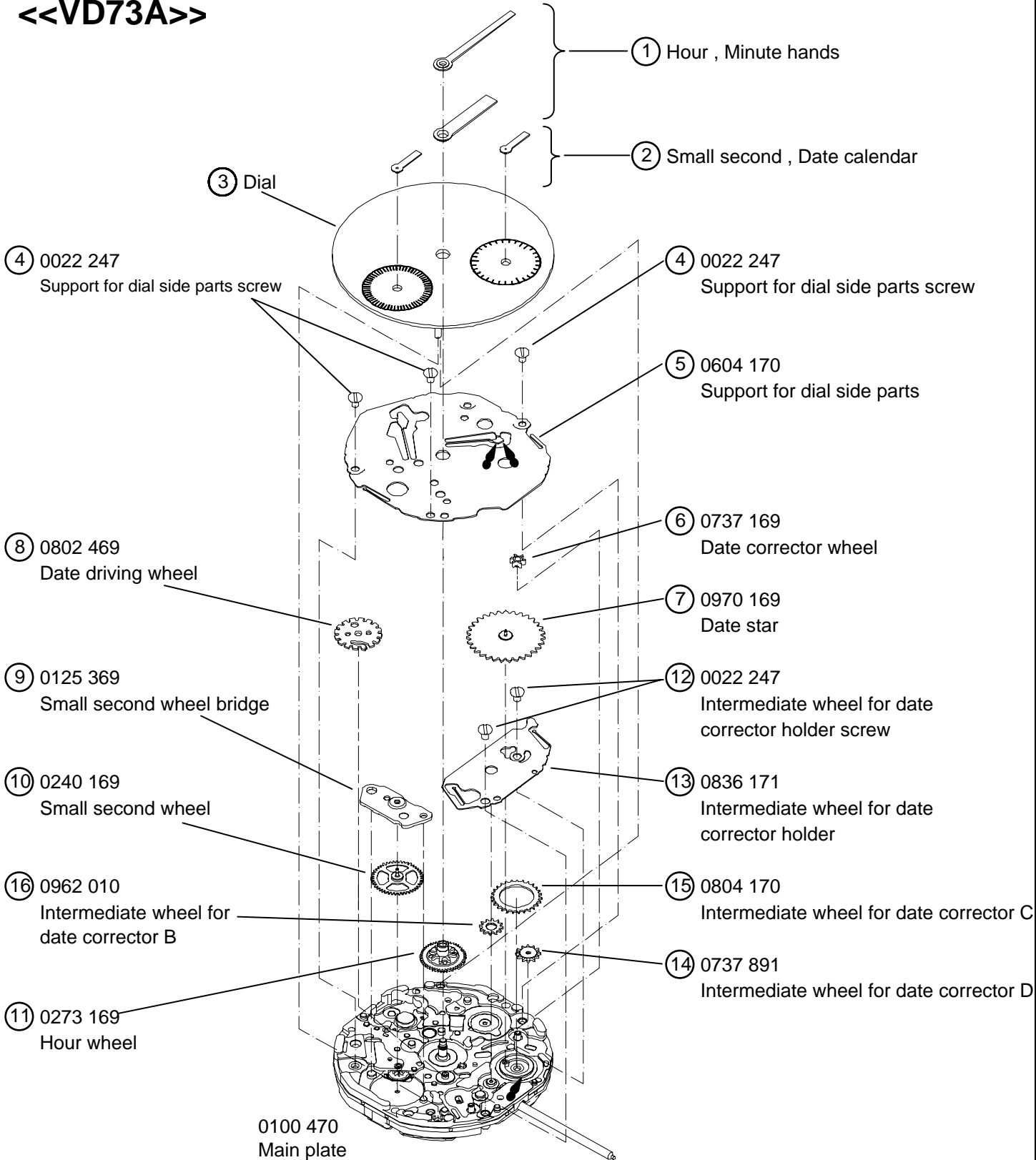
<<VD73A>>



Disassembling procedures Figs. ① ⇒ ⑳
Reassembling procedures Figs. ⑳ ⇒ ①

Lubricating : Types of oil Oil quantity
 Moebius A  Normal quantity
 Moebius F

<<VD74A>>

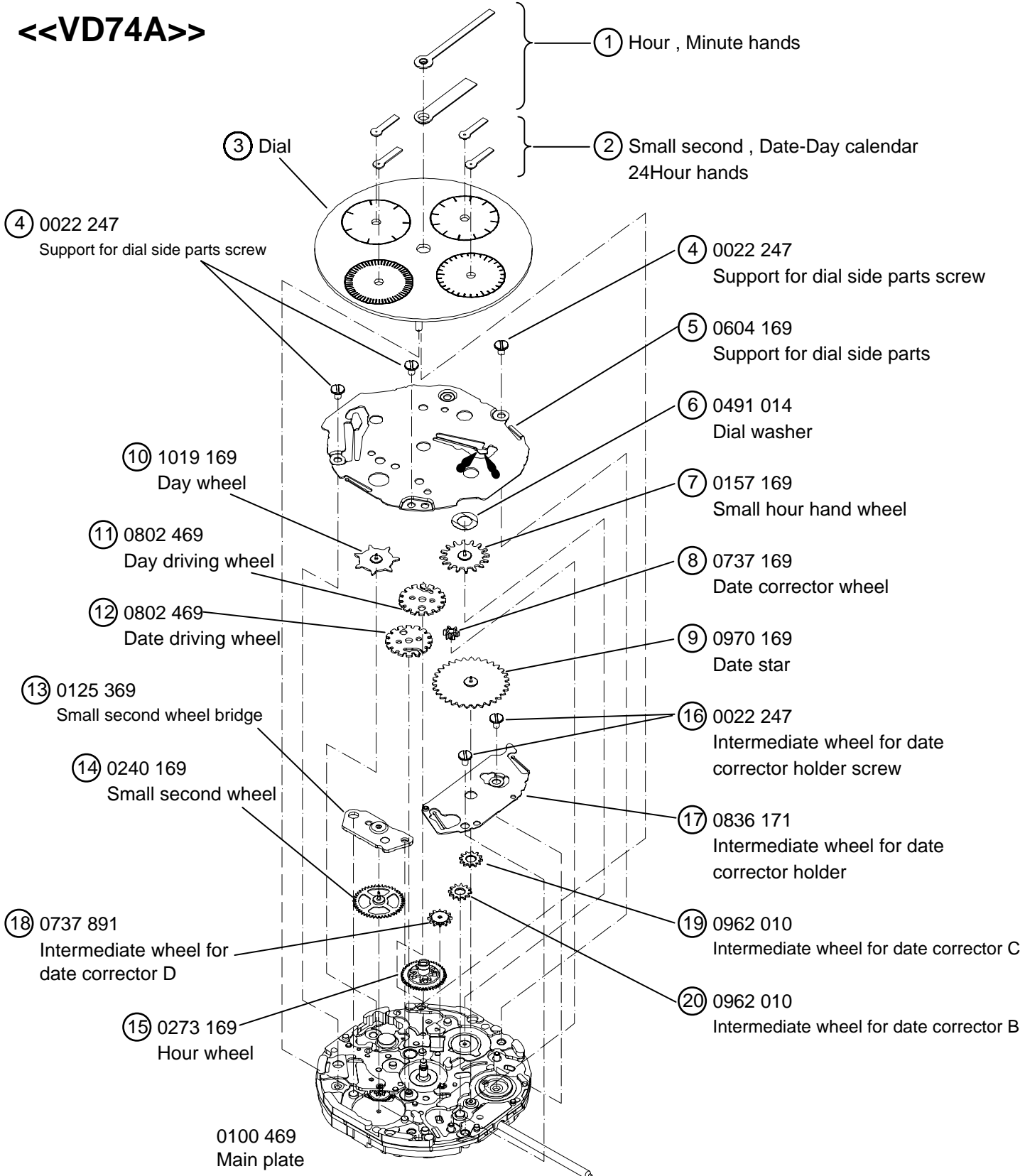

Disassembling procedures Figs. ① ⇒ ⑱

Reassembling procedures Figs. ⑱ ⇒ ①

Lubricating : Types of oil

Oil quantity

● Moebius A



Normal quantity

■ Moebius F

<<VD75A>>

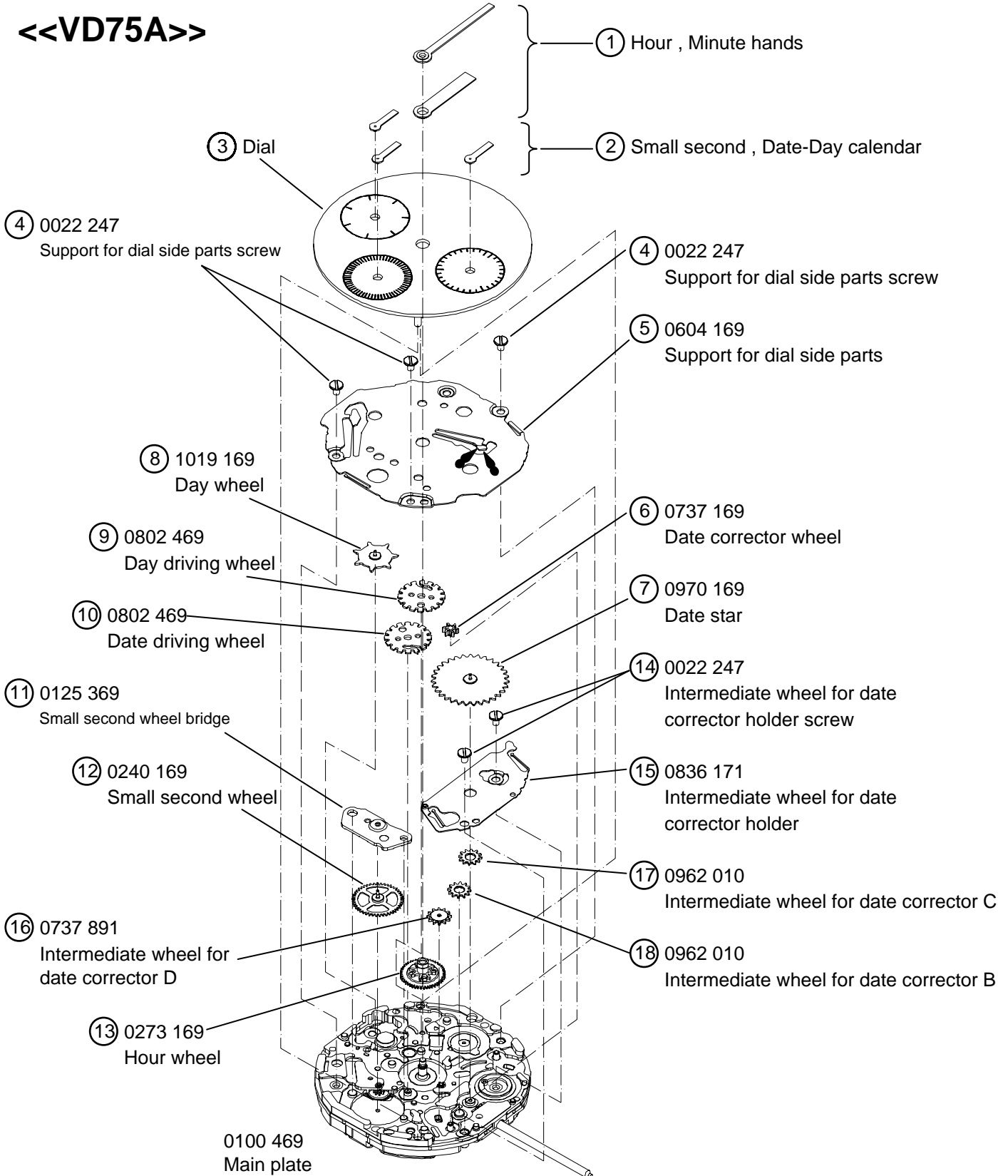

Disassembling procedures Figs. (1) ⇒ (18)

Reassembling procedures Figs. (18) ⇒ (1)

Lubricating : Types of oil

Oil quantity

Moebius A



Normal quantity

Moebius F

<<VD76A>>

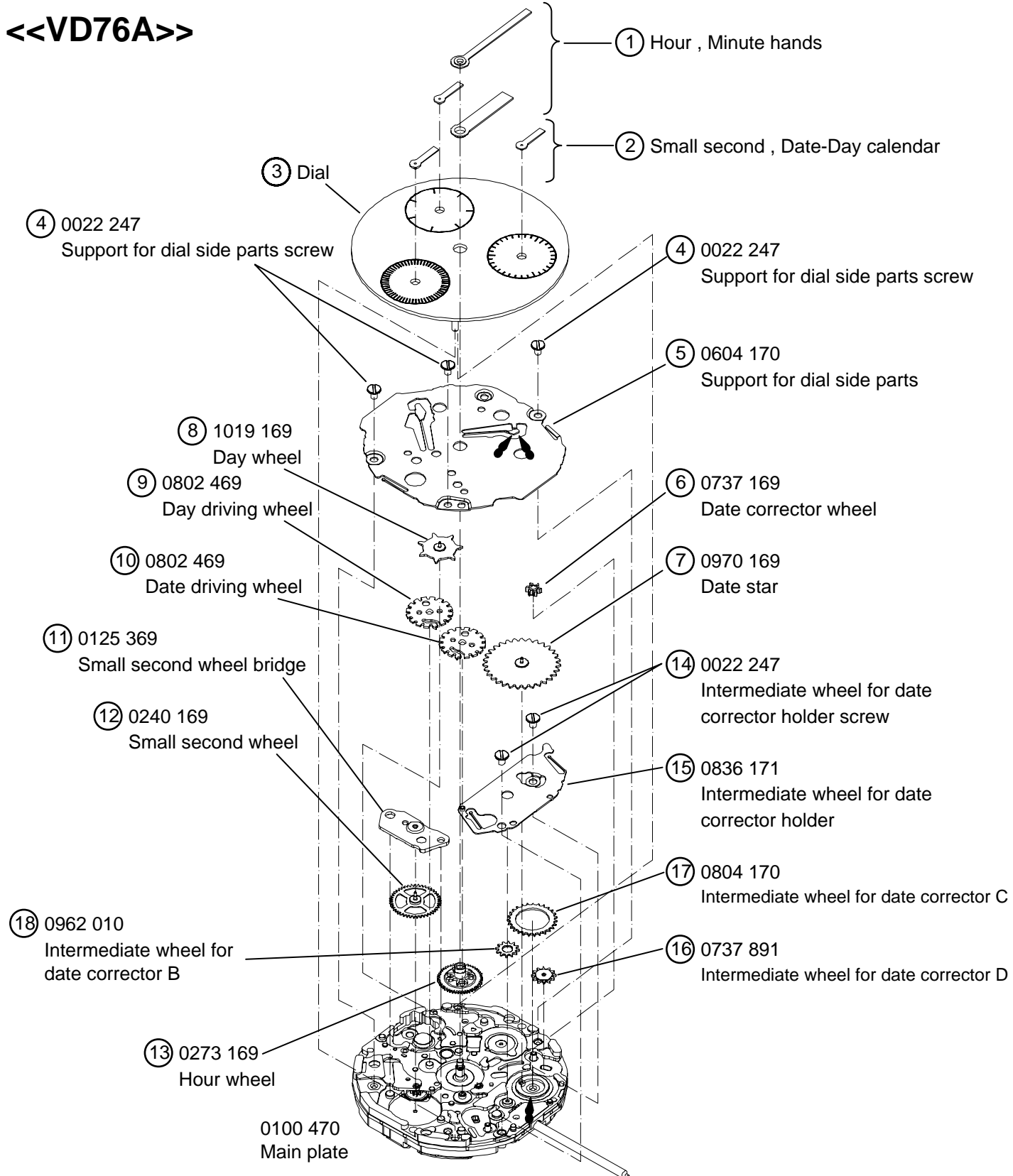

Disassembling procedures Figs.

① ⇒ ⑪

Reassembling procedures Figs.

⑪ ⇒ ①

Lubricating : Types of oil

Oil quantity

●▶ Moebius A

∞▶ Normal quantity

■▶ Moebius F

<<VD77A>>

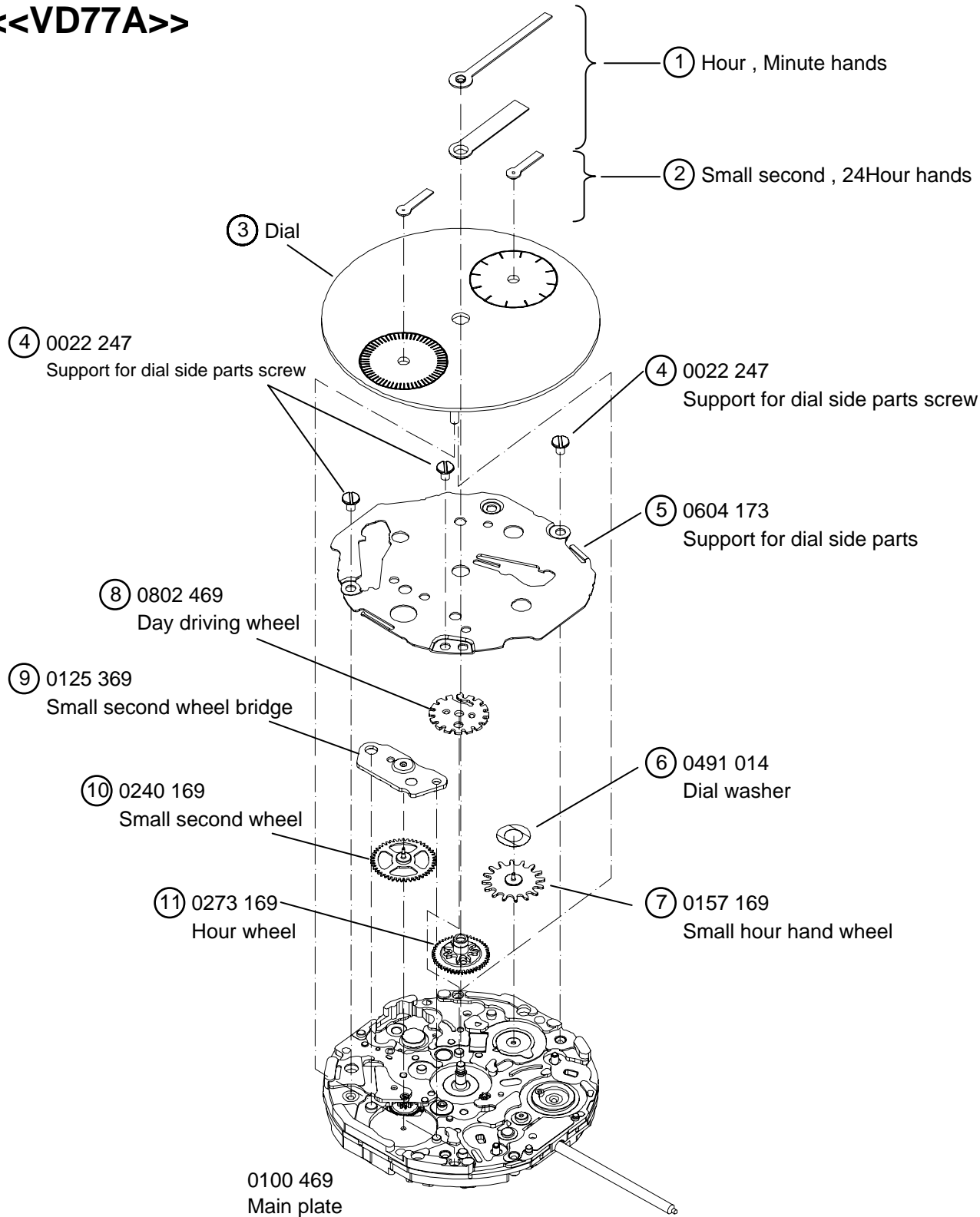

Disassembling procedures Figs.

① ⇒ ⑧

Reassembling procedures Figs.

⑧ ⇒ ①

Lubricating : Types of oil

Oil quantity

●▶ Moebius A



∞▶ Normal quantity

■▶ Moebius F

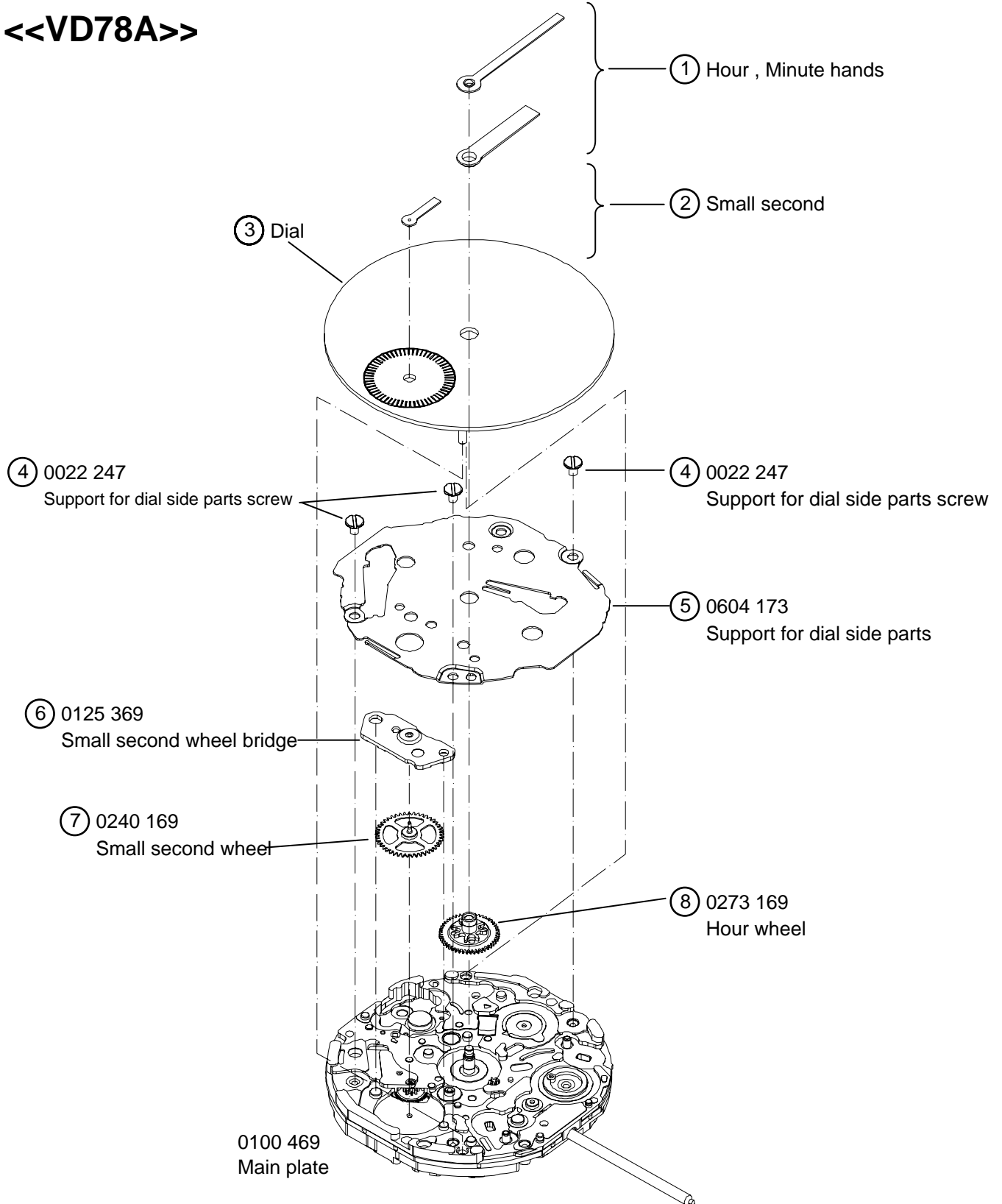
<<VD78A>>



Disassembling procedures Figs. (1) ⇒ (16)
Reassembling procedures Figs. (16) ⇒ (1)

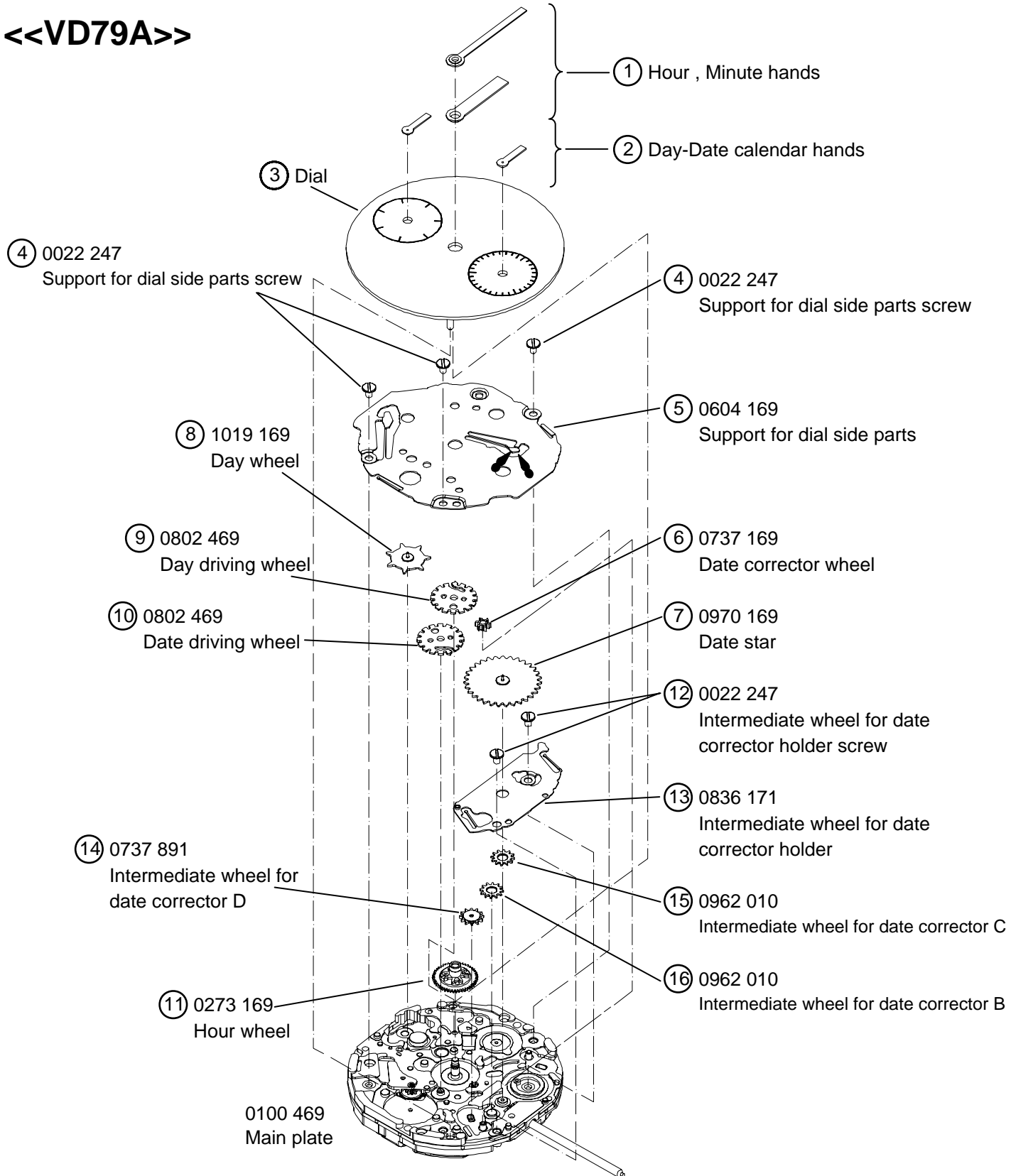

Lubricating : Types of oil Oil quantity
 Moebius A  Normal quantity
 Moebius F

<<VD79A>>



Disassembling procedures Figs. (1) ⇒ (22)
Reassembling procedures Figs. (22) ⇒ (1)

Lubricating : Types of oil Oil quantity

 Moebius A  Normal quantity
 Moebius F

***Refer to the 12pages for the each parts code**

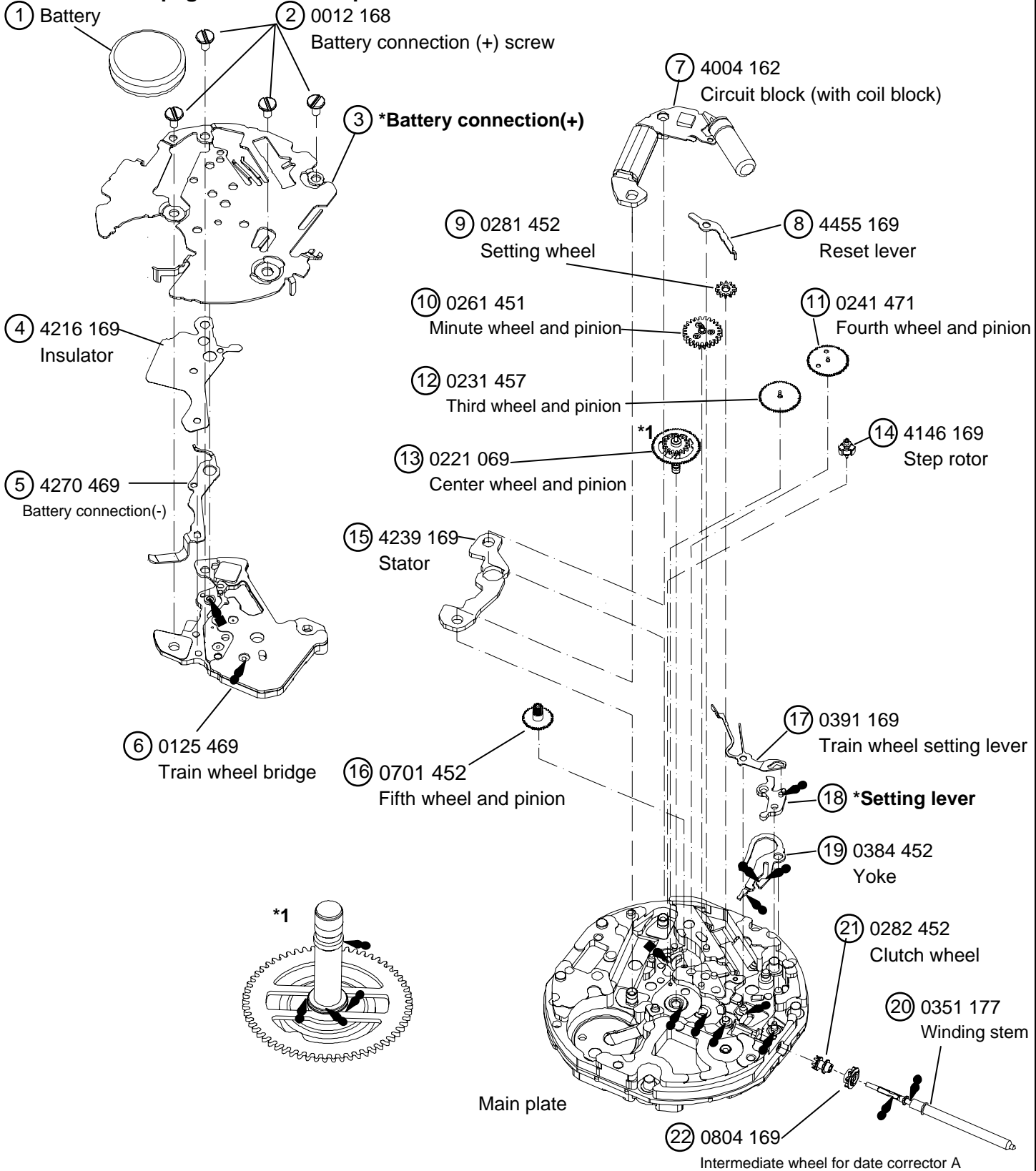

Remarks: **Different parts for each CAL.**

Parts name	Parts code	VD72A	VD73A	VD74A	VD75A	VD76A	VD77A	VD78A	VD79A
Main Plate	0100 469	—	—	○	○	—	○	○	○
	0100 470	○	○	—	—	○	—	—	—
Small second wheel	0240 169	—	○	○	○	○	○	○	—
Setting lever	0383 891	○	○	○	○	○	—	—	○
	0383 154	—	—	—	—	—	○	○	—
Battery connection(+)	4271 470	—	—	○	—	—	—	—	—
	4271 471	—	—	—	○	—	—	—	—
	4271 472	—	—	—	—	○	—	—	—
	4271 473	—	—	—	—	—	○	—	—
	4271 474	—	—	—	—	—	—	○	—
	4271 475	—	—	—	—	—	—	—	○
	4271 490	○	—	—	—	—	—	—	—
	2471 492	—	○	—	—	—	—	—	—
Date driving wheel	0802 469	○	○	○	○	○	—	—	○
Date star	0970 169	○	○	○	○	○	—	—	○
Intermediate wheel for date corrector A	0804 169	○	○	○	○	○	—	—	○
Intermediate wheel for date corrector B	0962 010	○	○	○	○	○	—	—	○
Intermediate wheel for date corrector C	0962 010	—	—	○	○	—	—	—	○
	0804 170	○	○	—	—	○	—	—	—
Intermediate wheel for date corrector D	0737 891	○	○	○	○	○	—	—	○
Date corrector wheel	0737 169	○	○	○	○	○	—	—	○
Intermediate wheel for date corrector holder	0836 171	○	○	○	○	○	—	—	○
Day driving wheel	0802 469	—	○	○	○	○	○	—	○
Day wheel	1019 169	—	○	○	○	○	—	—	○
Small hour hand wheel	0157 169	—	—	○	—	—	○	—	—
Small second wheel bridge	0125 369	—	○	○	○	○	○	○	—
Support for dial side parts	0604 169	—	—	○	○	—	—	—	○
	0604 170	○	○	—	—	○	—	—	—
	0604 173	—	—	—	—	—	○	○	—
Dial washer	0491 014	—	—	○	—	—	○	—	—
Intermediate wheel for date corrector holder screw	0022 247	○	○	○	○	○	—	—	○

*** All parts code are subject to change without notice.**

•The explanation here is only for the particular point of Cal.VD7A

1.REMARKS ON DISASSEMBLING AND REASSEMBLING

(1)HAND

•How to install hands

Place the movement directly on a flat metal plate or the like to install the hands.

Note: How to procedure hands

①Dial setting.

②Install the date calendar and small second hands at the 12 o'clock position.

③Pull out the crown to the second click position and rotation it clockwise the change date.

④Install the day calendar and 24hour and hour and minute hands at the 12 o'clock position.

•Cal.VD77A install the 24hour hand.

Pull out the crown to the second click position and rotation it clockwise to install 24hour hand.

※Cal.VD77A and VD78A not day-date calendar hands

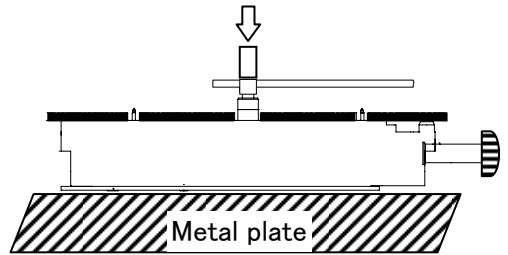

(2)Winding stem

•How to remove

While pushing the indented portion of the arrow pull out the winding stem.

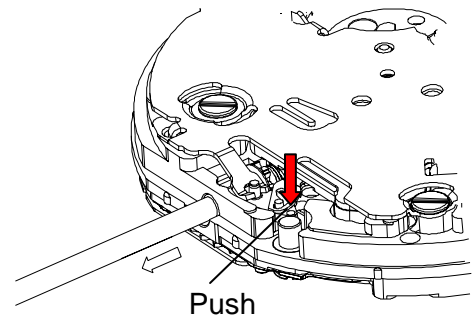

(3)Battery

•How to install

Insert the battery aslant in the direction shown by the arrow. Check the battery connection (+) securely touches the side face of the battery.

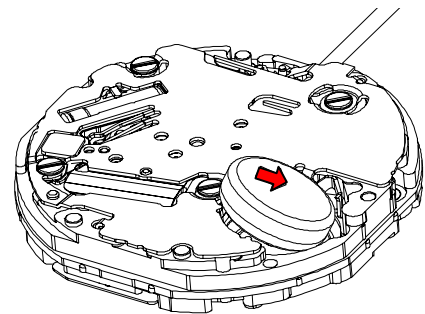

(4) Insulator

Notes: To insulate between the battery connection (+) and the battery connection (-), the insulator should put at the three pin securely as bellow.

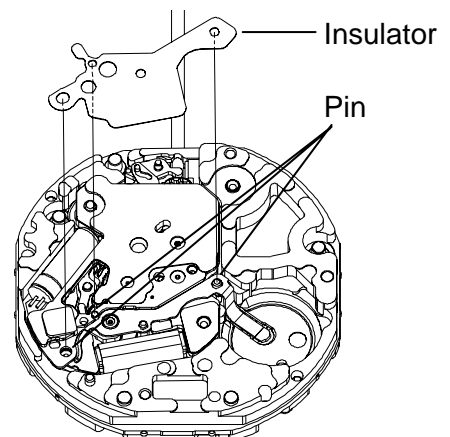

(5) Setting position (Notes at the time of disassembling and a reassembling)

·How to Date & Day driving wheels setting position

Note:

The indicator finger of a Date & Day driving wheels are setting position " O "mark of Main plate

«Cal.VD74A·VD75A·VD79A setting position»

«Cal.VD76A setting position»

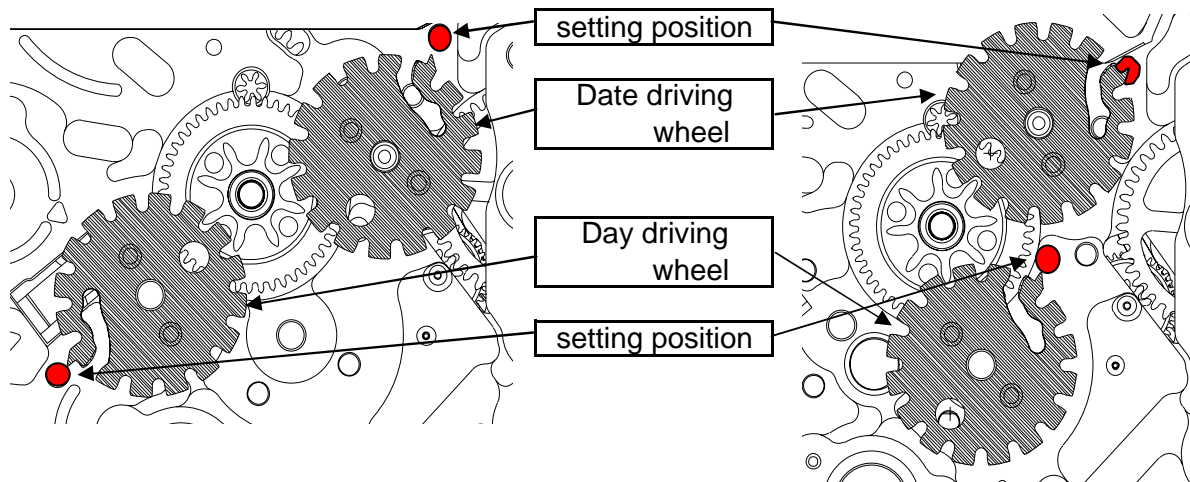
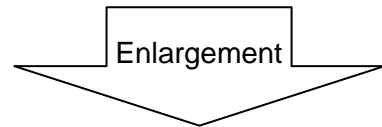
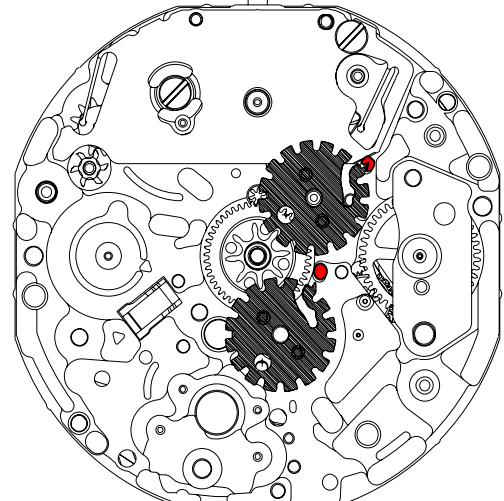
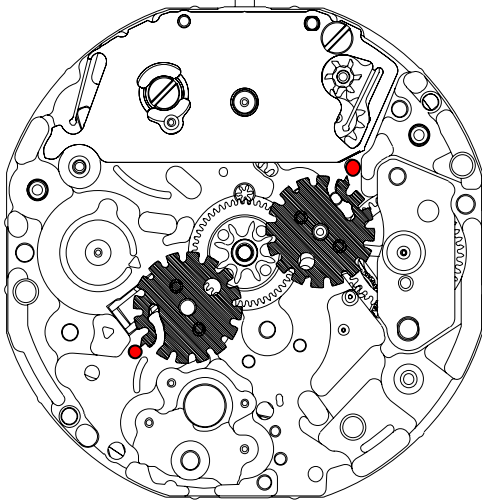

DISPLAY AND CROWN OPERATION

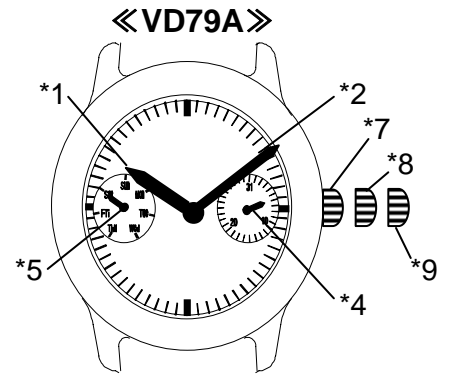
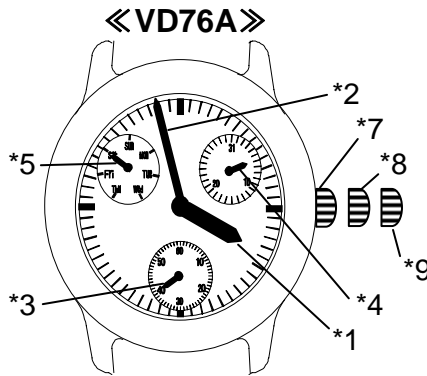
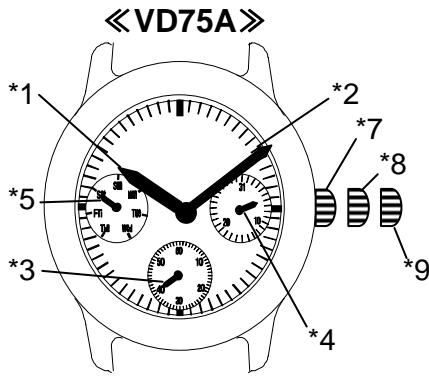
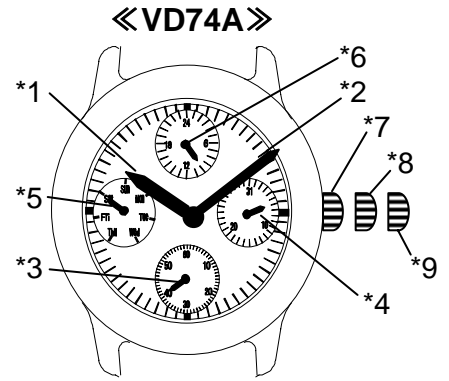
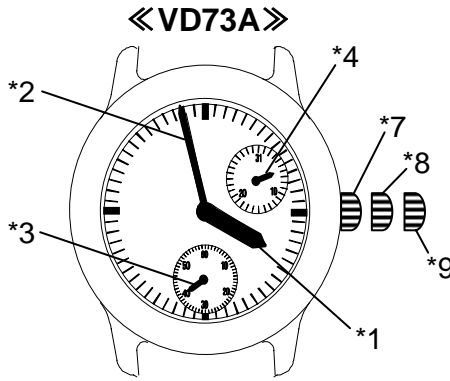
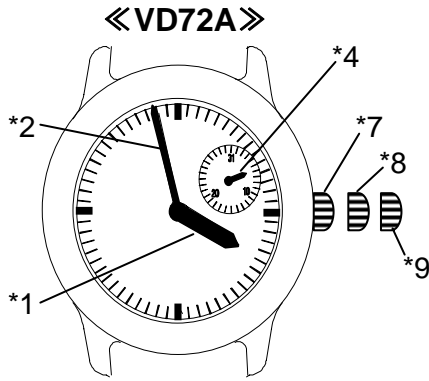

Note:

*1: Hour hand	*4: Date calendar hand	*7: Crown at normal position	*9: Second click
*2: Minute hand	*5: Day calendar hand	*8: First click	• Time setting
*3: Small second hand	*6: 24Hour hand	• Date setting (Quick change function)	

TIME SETTING

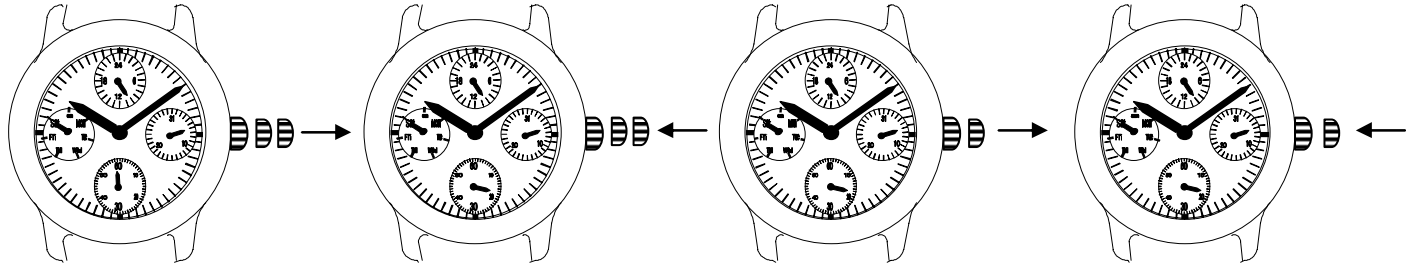

1. Pull out the crown to the second click when the small second hand is at the 12 O'clock position.

2. Push the crown back in to the normal position in signal. Pull out the crown to the first click .

3. Pull out the crown to the first click. turn the crown counter-clockwise to set the data. (Quick change function)

4. Push the crown back in to the normal position.

Turn the crown rotation to set the day of the week.

Turn the crown to set the hour and minute hands to the time.
(Check that AM / PM is set correctly)

*Do not set the date between 10:00 PM and 2:00 AM

Otherwise, the day may not change properly. If it is necessary to set the date during that time period, First change the time to any time outside it, set the date and then reset the correct time.

DISPLAY AND CROWN

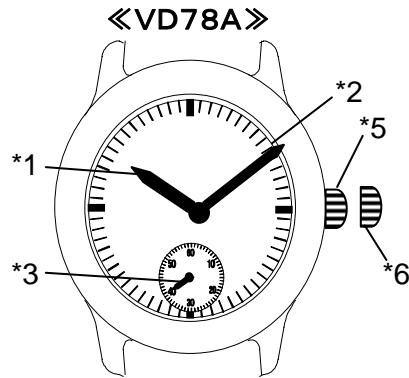
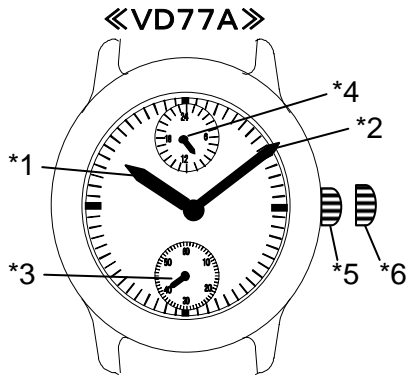

Note:

- *1: Hour hand
- *2: Minute hand
- *3: Small second hand
- *4: 24Hour hand
- *5: Crown at normal position
- *6: First click
• Time setting

TIME SETTING

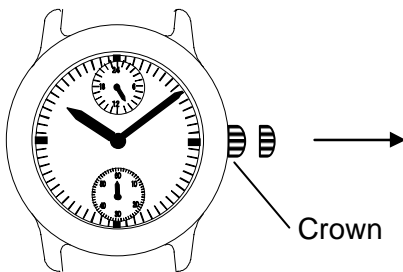

1. pull out the crown to the second click when the small second hand is at the 12 O'clock position.

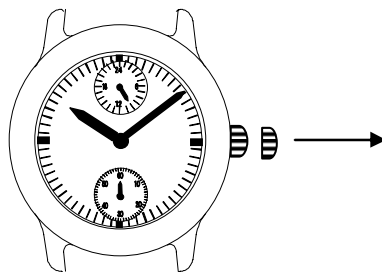

2. Turn the crown to set the hour and minute hands to the time. (Check that AM / PM is set correctly)

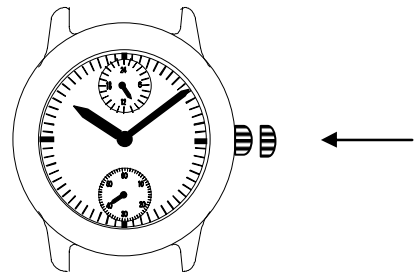

3. Push the crown back in to the normal position in accordance with a time signal.

Notes in time setting of Cal.VD7 series

When time setting is done with counterclockwise, date hand might be reversed.

The function, there is no problem.

Please set the date by using the quick change function when the date shown was incorrect.