

SEIKO

Quartz

Cal. 3863A

Cal. 3819A

PARTS LIST

Calibre No. <h1 style="text-align: center;">3863A</h1>	Jewels <h1 style="text-align: center;">5j</h1>	Style Name <h1 style="text-align: center;">Quartz 3003</h1>
--	--	---



Cal. 3863A

Characteristics
 Casing diameter: 25.60 ϕ mm
 Maximum height: 5.30 mm
 Frequency of quartz crystal oscillator: 16,384Hz
 (Hz = Hertz Cycle per second)
 Driving system: Step motor system
 Sweep second
 Regulation system:
 (Method of the replacement of the condenser
 Calendar (day & date)
 Instant setting device for day & date calendar
 Bilingual change-over system for day of week
 Second-setting device

131 831	221 838	231 838	241 838	261 838	271 838	282 838	354 838	361 838	376 838	
☆ 383 837	☆ 383 838	384 838	385 615	388 832	390 550	391 838	436 838	556 838	760 837	780 838
☆ 801 838	802 838	803 831	810 838	817 610	868 838	☆ 870 452	873 838			
☆ 884 830	☆ 884 831	963 838	986 838	4001 831	4002 838	☆ 4106 800				
☆ 4106 801	☆ 4106 803	☆ 4106 805	☆ 4106 807	☆ 4106 809	☆ 4106 831	4146 838	4151 831			
4216 836	4216 837	4239 837	4239 838	4246 832	4246 834	4256 838	☆ 4264 838	4270 838		
4283 845	☆ 4414 837	☆ 4414 838	4437 838	U.C.C. EPX-77 (or 303)						

022 282	022 434	022 435	022 436	022 437	022 446	022 468	022 558	022 753	022 761	2/1

☆⇒ Please see remarks on the next reverse page.

Calibre No.		Jewels	Style Name	
3863A		5j	Quartz 3003	
PART NO.	PART NAME	PART NO.	PART NAME	
131 831	Third wheel bridge	4270 838	Battery connection	
221 838	Center wheel & pinion	4283 845	Circuit holder	
231 838	Third wheel & pinion	☆ 4414 837	Insulating cap for battery	
241 838	Sweep second wheel & pinion	☆ 4414 838		
261 838	Minute wheel	4437 838	Insulating cover of circuit connection	
271 838	Hour wheel	U.C.C. EPX-77	Silver oxide battery	
282 838	Clutch wheel	(or 303)		
354 838	Winding stem	011 406	Upper hole jewel for sweep second wheel	
361 838	Second-setting lever spring	011 411	Upper hole jewel for step rotor	
376 838	Hour wheel guard with intermediate wheel for day correction	011 411	Lower hole jewel for step rotor	
☆ 383 837	Setting lever	022 282	Date driving wheel screw	
☆ 383 838	Setting lever	022 434	Coil block screw	
384 838	Yoke (Clutch lever)	022 434	Rotor stator screw	
385 615	Yoke spring (Clutch lever spring)	022 435	Third wheel bridge screw	
388 832	Setting lever spring	022 436	Hour wheel guard screw	
390 560	Setting lever axle	022 436	Second jumper screw	
391 838	Second-setting lever	022 436	Circuit block screw	
436 838	Lower end-piece for third wheel	022 437	Circuit holder screw	
556 838	Date finger	022 437	Crystal holding spring screw	
760 837	Second jumper	022 437	Condenser screw for oscillator regulation	
780 838	Insulating seat for battery connection	022 437	Crystal lead terminal screw	
☆ 801 838	Date dial	022 446	Screw for insulating cover of circuit connection	
802 838	Date driving wheel	022 446	Setting wheel lever screw	
803 831	Setting wheel lever complete	022 468	Setting lever spring screw	
810 838	Date jumper	022 558	Lower end-piece screw for third wheel	
817 610	Intermediate date wheel	022 753	Day jumper screw	
868 838	Day finger	022 761	Dial screw	
☆ 870 452	Day star with dial disk (English ↔ Spanish)	023 111	Tube for third wheel bridge screw	
873 838	Day jumper	023 842	Date jumper pin	
☆ 884 830	Holding ring for dial			
☆ 884 831	Holding ring for dial			
963 838	Snap for day star with dial disk			
986 838	Day-date corrector wheel rocking lever			
4001 831	Circuit block			
4002 838	Coil block			
☆ 4106 800				
☆ 4106 801				
☆ 4106 802				
☆ 4106 803				
☆ 4106 804				
☆ 4106 805				
☆ 4106 806	Condenser for oscillator regulation			
☆ 4106 807				
☆ 4106 808				
☆ 4106 809				
☆ 4106 830				
☆ 4106 831				
☆ 4106 832				
4146 838	Step rotor			
4151 831	Crystal oscillator			
4216 836	Insulator for battery connection			
4216 837	Insulator for circuit			
4239 837	Rotor stator A			
4239 838	Rotor stator B			
4246 832	Ground terminal			
4246 834	Terminal for reset connection			
4256 838	Crystal holding spring			
☆ 4264 838	Battery connection for plus terminal			

☆⇒ Please see remarks on the reverse page.

Part numbers in light letters are not shown in photos.

Calibre No. 3863A	Jewels 5j	Style Name Quartz 3003
------------------------------------	----------------------------	---

Remarks.

Setting lever ——— There are two types of setting levers. They are used according to the structure of cases and the dial diameter. Select a suitable one from the following sizes and types indicated in the photos.

- ☆ 383 837..... { ① Used for one-piece type case with round dial of diameter 27.5~28.5 mm.
 ② Used for square type case with round dial of diameter 26.5~27.5 mm.
- ☆ 383 838..... { ① Used for screw type case with round dial of diameter 26.5~28.5 mm.
 ② Used for one-piece type case with round dial of diameter 26.5 mm.
 ③ Used for square type case with round dial of diameter 25.5 mm.

When the number of the setting lever is unknown, specify ① Cal. No. ② Case No. ③ Dial No. when ordering.

Date dial

☆ 801 838.....Used when both the crown and the date frame are located at 3 o'clock position.

If the date dial is required in any other type, specify ① Cal. No. ② the crown position ③ the date frame position and ④ Dial. No.

Day star with dial disk

☆ 870 452(English ↔ Spanish)Used when both the crown and the day frame are located at 3 o'clock position.

If the day star with dial disk is required in any other type, specify the number printed on the disk.

Holding ring for dial ——— Refer to shapes in photos.

☆ 884 830.....Used for except one-piece type case.

☆ 884 831.....Used only for one-piece type case.

If the shape of the holding ring for dial is different from the above, or if the Part No. of the holding ring for dial is unknown, specify ① Cal. No. ② Case No. and ③ Dial. No. when ordering.

Condenser for oscillator regulation

There are 13 types of regulator condensers, each of different capacity. And each condenser has number printed on the reverse side.

Select appropriate condenser based on following ; each number represents an adjusting rate of approximately 0.5 seconds plus/minus per 24 hours.

When ordering, indicate the suitable Part No. of the regulator condenser by referring to the following list.

Number on Regulator condenser	Part No.	Number on Regulator condenser	Part No.
0	4106 800	7	4106 807
1	4106 801	8	4106 808
2	4106 802	9	4106 809
3	4106 803	X	4106 830
4	4106 804	Y	4106 831
5	4106 805	Z	4106 832
6	4106 806		







































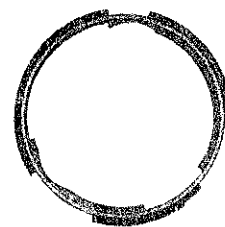







































































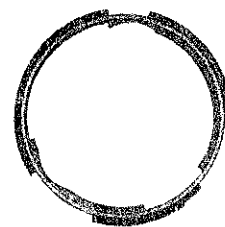







































































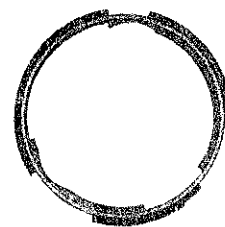



































Battery connection for plus terminal

☆ 4264 838.....Used for watches except one-piece type case.

Insulating cap for battery ——— Refer to shapes in photos.

☆ 4414 837.....Used for screw type case.

☆ 4414 838.....Used for one-piece type case.

Calibre No. <h1 style="text-align: center;">3819A</h1>	Jewels <h1 style="text-align: center;">7j</h1>	Style Name <h1 style="text-align: center;">Quartz 2002</h1> <p style="text-align: center;">(DUAL-ZONE TIMER)</p>																																																																									
 <p style="text-align: center;">Cal. 3819A</p>		Characteristics Casing diameter : 25.60 ϕ mm Maximum height : 5.30 mm Frequency of quartz crystal oscillator : 16,384 Hz (Hz=Hertz Cycle per second) Driving system : Step motor system Regulation system : Method of the replacement of the condenser Sweep second and sub-hour hand Second-setting device Calendar (date) Instant date and sub-hour hand setting																																																																									
<table style="width: 100%; border-collapse: collapse;"> <tr> <td style="text-align: center;"> 131 839</td> <td style="text-align: center;"> 221 832</td> <td style="text-align: center;"> 231 838</td> <td style="text-align: center;"> 241 832</td> <td style="text-align: center;"> 261 838</td> <td style="text-align: center;"> 271 832</td> <td style="text-align: center;"> 282 832</td> <td style="text-align: center;"> 354 838</td> <td style="text-align: center;"> 361 838</td> </tr> <tr> <td style="text-align: center;"> 376 832</td> <td style="text-align: center;"> 383 832</td> <td style="text-align: center;"> 384 838</td> <td style="text-align: center;"> 385 615</td> <td style="text-align: center;"> 388 832</td> <td style="text-align: center;"> 390 560</td> <td style="text-align: center;"> 391 838</td> <td style="text-align: center;"> 436 838</td> <td style="text-align: center;"> 556 838</td> </tr> <tr> <td style="text-align: center;"> 760 837</td> <td style="text-align: center;"> 780 838</td> <td style="text-align: center;"> ☆801 838</td> <td style="text-align: center;"> 802 838</td> <td style="text-align: center;"> 803 832</td> <td style="text-align: center;"> 808 838</td> <td style="text-align: center;"> 809 832</td> <td style="text-align: center;"> 810 838</td> <td style="text-align: center;"> 817 610</td> </tr> <tr> <td style="text-align: center;"> 884 830</td> <td style="text-align: center;"> 986 838</td> <td style="text-align: center;"> 990 832</td> <td style="text-align: center;"> 4001 838</td> <td style="text-align: center;"> 4002 838</td> <td style="text-align: center;"> ☆4106 800</td> <td style="text-align: center;"> ☆4106 801</td> <td style="text-align: center;"> ☆4106 802</td> <td style="text-align: center;"> ☆4106 803</td> <td style="text-align: center;"> ☆4106 805</td> <td style="text-align: center;"> ☆4106 806</td> <td style="text-align: center;"> ☆4106 807</td> <td style="text-align: center;"> ☆4106 808</td> <td style="text-align: center;"> ☆4106 809</td> <td style="text-align: center;"> ☆4106 831</td> <td style="text-align: center;"> ☆4106 830</td> <td style="text-align: center;"> ☆4106 832</td> <td style="text-align: center;"> 4106 837</td> <td style="text-align: center;"> 4146 838</td> <td style="text-align: center;"> 4151 838</td> <td style="text-align: center;"> 4216 836</td> </tr> <tr> <td style="text-align: center;"> 4216 837</td> <td style="text-align: center;"> 4215 838</td> <td style="text-align: center;"> 4239 837</td> <td style="text-align: center;"> 4239 838</td> <td style="text-align: center;"> 4246 834</td> <td style="text-align: center;"> 4246 835</td> <td style="text-align: center;"> 4247 833</td> <td style="text-align: center;"> 4256 838</td> <td style="text-align: center;"> 4264 838</td> <td style="text-align: center;"> 4270 838</td> <td style="text-align: center;"> 4283 846</td> <td style="text-align: center;"> 4414 837</td> <td style="text-align: center;"> 4437 838</td> <td style="text-align: center;"> U.C.C. EPX-77 (or 303)</td> </tr> <tr> <td style="text-align: center;"> 022 270</td> <td style="text-align: center;"> 022 282</td> <td style="text-align: center;"> 022 286</td> <td style="text-align: center;"> 022 373</td> <td style="text-align: center;"> 022 377</td> <td style="text-align: center;"> 022 446</td> <td style="text-align: center;"> 022 468</td> <td style="text-align: center;"> 022 491</td> <td style="text-align: center;"> 022 558</td> <td style="text-align: center;"> 022 753</td> <td style="text-align: center;"> 022 761</td> </tr> </table>			 131 839	 221 832	 231 838	 241 832	 261 838	 271 832	 282 832	 354 838	 361 838	 376 832	 383 832	 384 838	 385 615	 388 832	 390 560	 391 838	 436 838	 556 838	 760 837	 780 838	 ☆801 838	 802 838	 803 832	 808 838	 809 832	 810 838	 817 610	 884 830	 986 838	 990 832	 4001 838	 4002 838	 ☆4106 800	 ☆4106 801	 ☆4106 802	 ☆4106 803	 ☆4106 805	 ☆4106 806	 ☆4106 807	 ☆4106 808	 ☆4106 809	 ☆4106 831	 ☆4106 830	 ☆4106 832	 4106 837	 4146 838	 4151 838	 4216 836	 4216 837	 4215 838	 4239 837	 4239 838	 4246 834	 4246 835	 4247 833	 4256 838	 4264 838	 4270 838	 4283 846	 4414 837	 4437 838	 U.C.C. EPX-77 (or 303)	 022 270	 022 282	 022 286	 022 373	 022 377	 022 446	 022 468	 022 491	 022 558	 022 753	 022 761
 131 839	 221 832	 231 838	 241 832	 261 838	 271 832	 282 832	 354 838	 361 838																																																																			
 376 832	 383 832	 384 838	 385 615	 388 832	 390 560	 391 838	 436 838	 556 838																																																																			
 760 837	 780 838	 ☆801 838	 802 838	 803 832	 808 838	 809 832	 810 838	 817 610																																																																			
 884 830	 986 838	 990 832	 4001 838	 4002 838	 ☆4106 800	 ☆4106 801	 ☆4106 802	 ☆4106 803	 ☆4106 805	 ☆4106 806	 ☆4106 807	 ☆4106 808	 ☆4106 809	 ☆4106 831	 ☆4106 830	 ☆4106 832	 4106 837	 4146 838	 4151 838	 4216 836																																																							
 4216 837	 4215 838	 4239 837	 4239 838	 4246 834	 4246 835	 4247 833	 4256 838	 4264 838	 4270 838	 4283 846	 4414 837	 4437 838	 U.C.C. EPX-77 (or 303)																																																														
 022 270	 022 282	 022 286	 022 373	 022 377	 022 446	 022 468	 022 491	 022 558	 022 753	 022 761																																																																	

☆⇨ Please see remarks on the next reverse page.

Calibre No.		Jewels	Style Name	
3819A		7j	Quartz 2002 (DUAL-ZONE TIMER)	
PART NO.	PART NAME	PART NO.	PART NAME	
131 839	Third wheel bridge	4270 838	Battery connection	
221 832	Center wheel & pinion	4283 846	Circuit holder	
231 838	Third wheel & pinion	4414 837	Insulating cap for battery	
241 832	Forth wheel & pinion	4437 838	Insulating cover of circuit connection	
261 838	Minute wheel	U.C.C.EPX-77	Silver oxide battery	
271 832	Hour wheel(with sub-hour hand wheel)	(or 303)		
282 832	Clutch wheel	011 140	Lower hole jewel for sweep second wheel	
354 838	Winding stem	011 406	Upper hole jewel for third wheel	
361 838	Second-setting lever spring	011 406	Upper hole jewel for sweep second wheel	
376 832	Hour wheel guard	011 411	Upper hole jewel for step rotor	
383 832	Setting lever	011 411	Lower hole jewel for step rotor	
384 838	Yoke (Clutch lever)	022 270	Condenser screw for oscillator regulation	
385 615	Yoke spring (Clutch lever spring)	022 270	Crystal lead terminal screw	
388 832	Setting lever spring	022 282	Date driving wheel screw	
390 560	Setting lever axle	022 286	Coil block screw	
391 838	Second-setting lever	022 286	Rotor stator screw	
436 838	Lower end-piece for third wheel	022 373	Hour wheel guard screw	
556 838	Date finger	022 373	Second jumper screw	
760 837	Second jumper	022 373	Circuit block screw	
780 838	Insulating seat for battery connection	022 373	Screw for condenser of battery protection	
☆ 801 838	Date dial	022 373	Screw for insulating cover of circuit connection	
802 838	Date driving wheel	022 377	Third wheel bridge screw	
803 832	Setting wheel lever complete	022 446	Setting wheel lever screw	
808 838	Date dial guard	022 468	Setting lever spring screw	
809 832	Guard for date jumper	022 491	Circuit holder screw	
810 838	Date jumper	022 491	Crystal holding spring screw	
817 610	Intermediate date wheel	022 558	Lower end-piece screw for third wheel	
884 830	Holding ring for dial	022 753	Guard screw for date jumper	
986 838	Date corrector wheel rocking lever	022 761	Dial screw	
990 832	Date driving wheel holder	023 111	Tube for third wheel bridge screw	
4001 838	Circuit block	023 842	Date jumper pin	
4002 838	Coil block			
☆ 4106 800				
☆ 4106 801				
☆ 4106 802				
☆ 4106 803				
☆ 4106 804				
☆ 4106 805				
☆ 4106 806	Condenser for oscillator regulation			
☆ 4106 807				
☆ 4106 808				
☆ 4106 809				
☆ 4106 830				
☆ 4106 831				
☆ 4106 832				
4106 837	Condenser of battery protection			
4146 838	Step rotor			
4151 838	Crystal oscillator			
4216 836	Insulator for battery connection			
4216 837	Insulator A for circuit			
4216 838	Insulator B for circuit			
4239 837	Rotor stator A			
4239 838	Rotor stator B			
4246 834	Terminal for reset connection			
4246 835	Ground terminal			
4247 833	Insulating ring for condenser of battery protection			
4256 838	Crystal holding spring			
4264 838	Battery connection for plus terminal			

☆⇒ Please see remarks on the reverse page.

Part numbers in light letters are not shown in photos.

Calibre No. <h1 style="text-align: center;">3819A</h1>	Jewels <h1 style="text-align: center;">7j</h1>	Style Name <h2 style="text-align: center;"><i>Quartz</i> 2002</h2> <p style="text-align: center;">(DUAL-ZONE TIMER)</p>
--	--	---

Remarks :

Date dial

☆ 801 838.....Used when both the crown and the date frame are located at 3 o'clock position.

If the date dial is required in any other type, specify ① Cal. No. ② the crown position ③ the date frame position and ④ Dial. No.

Condenser for oscillator regulation

There are 13 types of regulator condensers, each of different capacity. And each condenser has number printed on the reverse side.

Select appropriate condenser based on following; each number represents an adjusting rate of approximately 0.5 seconds plus/minus per 24 hours.

When ordering, indicate the suitable Part No. of the regulator condenser by referring to the following list.

Number on Regulator condenser	Part No.	Number on Regulator condenser	Part No.
0	4106 800	7	4106 807
1	4106 801	8	4106 808
2	4106 802	9	4106 809
3	4106 803	X	4106 830
4	4106 804	Y	4106 831
5	4106 805	Z	4106 832
6	4106 806		

SEIKO

QUARTZ

CAL. 38SERIES (SUPPLEMENT)

PARTS LIST

The circuit block of Calibre 38 series has been supplied without the crystal oscillator except Cal. 3823 and the crystal oscillator has been supplied separately.

However, in order to facilitate repair services the circuit block will be supplied together with the crystal oscillator, and the regulation system of the circuit block will be replaced with the trimmer condenser from December, 1978.

I. New parts

Cal.	Ordinary Parts	New Parts
3803 3819	Circuit block (without crystal oscillator) 4001 838 Crystal oscillator 4151 838	Circuit block (with crystal oscillator and trimmer condenser) 4001 838
3823	Circuit block (with crystal oscillator) 4000 838	Circuit block (with crystal oscillator and trimmer condenser) 4000 838
3863	Circuit block (without crystal oscillator) 4001 831 Crystal Oscillator 4151 831	Circuit block (with crystal oscillator and trimmer condenser) 4001 831

Remarks: A new circuit block has the same parts number as that of an ordinary circuit block.

2. Difference between ordinary parts and new parts

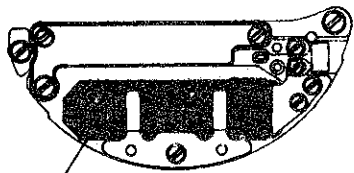
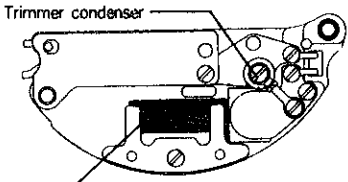
	Ordinary Parts	New Parts
Parts supply	<ul style="list-style-type: none"> ○ Circuit block ○ Crystal oscillator They have been supplied separately. (The circuit block has been supplied together with the crystal oscillator for Cal. 3823.)	<ul style="list-style-type: none"> ○ Circuit block (The circuit block and the crystal oscillator will be supplied together, but the circuit bridge plate will be supplied separately.)
Regulation system	Cal. 3823: Step variable condenser Cal. 3803 and 3819: Oscillator Regulation Condenser Cal. 3863: Oscillator Regulation Condenser or Trimmer condenser	The trimmer condenser will be used for all calibres.
Differences in appearance	 <p>Large crystal oscillator (16,384 Hz.)</p>	 <p>Trimmer condenser</p> <p>Small crystal oscillator (32,768 Hz.)</p>

3. Discernment color of the circuit block

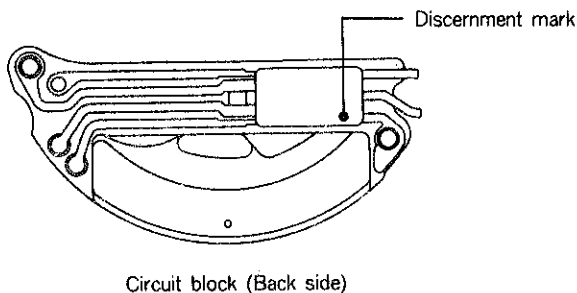

- Discernment mark
- Cal. 3823White
 - Cal. 3803 and 3819.....Blue
 - Cal. 3863No discernment mark

4. Remarks for replacing the parts

- (1) **Circuit block**
As a new circuit block is made up together with the crystal oscillator and circuit block, both the crystal oscillator and the circuit block can not be replaced separately.
- (2) **Circuit bridge plate**
As the new circuit block is not supplied together with the circuit bridge plate.
When replacing the circuit block, reuse the circuit bridge plate used for the ordinary circuit block.
- (3) **Regulation system**
 - Time accuracy is adjusted by turning the trimmer condenser.
 - Time accuracy of all calibres should be adjusted by turning the trimmer condenser although the watch is provided with both the oscillator regulation condenser and the trimmer condenser.

TECHNICAL GUIDE

SEIKO
Quartz

CAL.3863A & 3819A

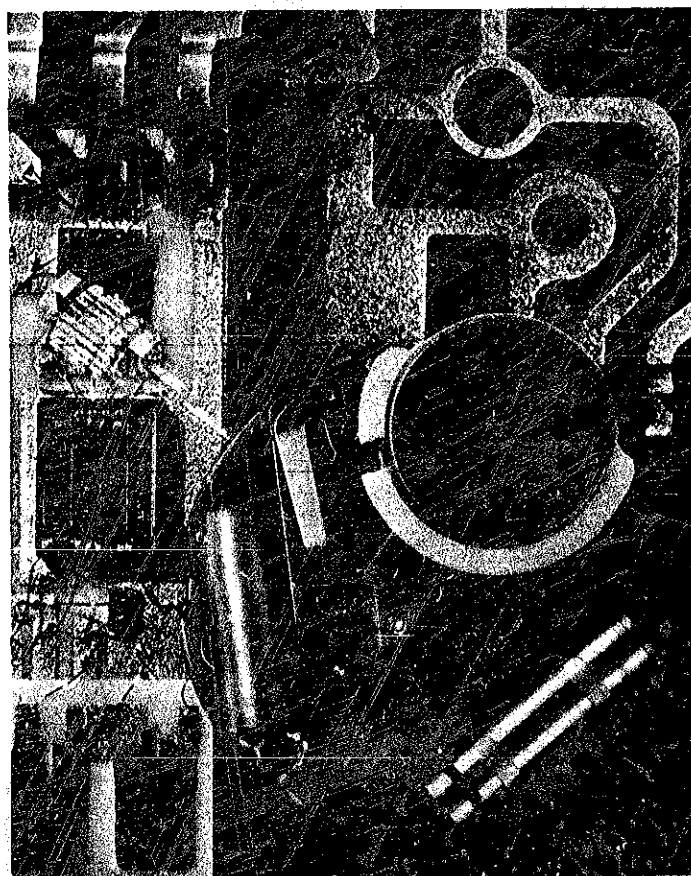

Cal. 3863A SEIKO QUARTZ 3003

SEIKO Quartz Crystal watch Cal. 3863A is an extremely accurate timepiece—the result of advanced precision technology for wrist watches for practical use, which has basically the same functions and mechanisms as those of the SEIKO Crystal watch, "38 Series," known for its extreme reliability.

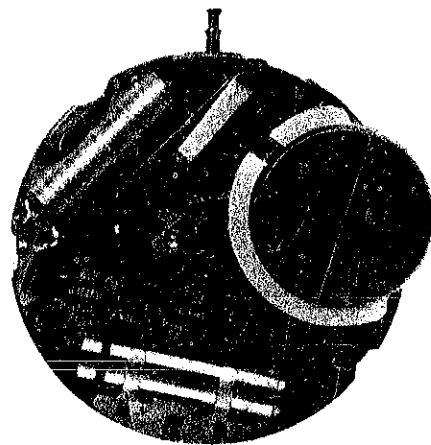

Movement

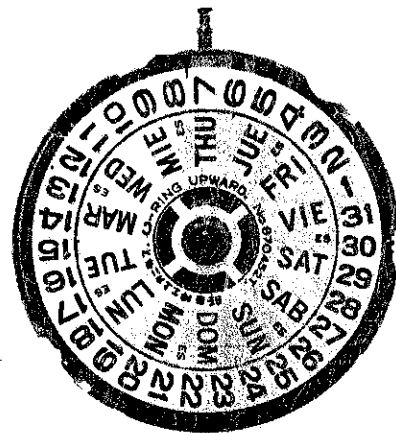

Cal. 3863A SEIKO QUARTZ 3003

1. Specifications

Additional mechanisms	Calendar (day & date) Bilingual change-over system for day of week ○ Instant day and date setting ○ Second setting device ○ Electronic circuit reset switch				
Crystal oscillator	16,384 Hz (Hz = Hertz . . . cycles per second)				
Loss/gain	Loss/gain at normal temperature Monthly rate: less than 15 seconds				
Casing diameter	25.6 mmφ				
Height	5.3 mm				
Operational temperature range	-10°C ~ +60°C				
Driving system	Step motor system				
Regulation system	Method of the replacement of the condensers				
Battery power	Silver oxide battery U.C.C. EPX-77 (or 303)				
Locations of jewels	No. of jewels: 5 jewels				
		Third wheel and pinion	Sweep second wheel and pinion	Step roter	Others
	Upper hole jewel		○	○	
	Lower hole jewel	○		○	
Others				○ (Second jumper finger jewel)	

2. Features

- (1) The crystal oscillator generates a stabilized oscillation of 16,384 Hz.
- (2) An ultrasmall, crystal quartz watch with a casing diameter of 25.6 mmφ.
- (3) The one-second hand operation system by unique step motor offers high stability.
- (4) A device for setting time to the precise second.
- (5) Servicing of the watch is easy as the movement consists of three separate

- sections—mechanical, coil block and electronic circuit.
- (6) A bilingual change-over system for day of week, and instant day and date setting.
- (7) Battery life exceeds one year.

* It has the same basic mechanism and structure as Cal. 3803A.

3. Disassembling, assembling and lubricating

The methods of disassembling, assembling and lubricating of Cal. 3863A are basically the same as those for Cal. 3803A.

Please refer to the SEIKO Technical Guide of Cal. 3803A except for the following disassembling and assembling procedures of the circuit block.

3-1. Disassembling and assembling of the circuit block

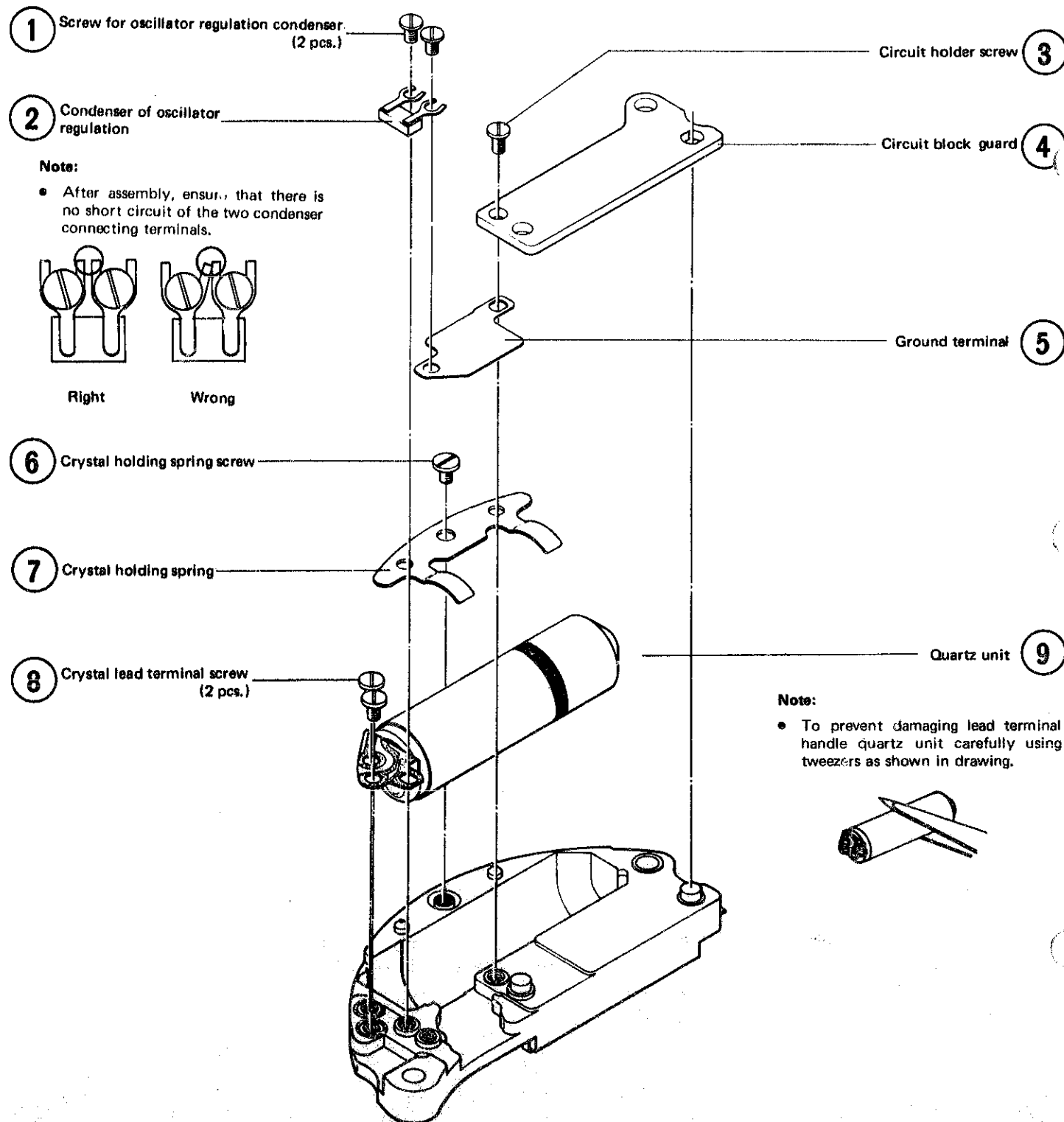

4. Testing and adjusting of time accuracy

4-1. Testing time accuracy

The time accuracy test is made with the Quartz tester. When testing with the Quartz tester, there will be a slight difference between the tested time and actual time accuracy as the room temperature and the watch temperature on the wrist are not the same.

For example, when the room temperature is 25°C, the Quartz tester will show plus figures, because the watch is so designed that it maintains high accuracy at the temperature on the wrist which is generally 30°C.

The watch's accuracy is within plus/minus 20 seconds per month, or this can be calculated within plus/minus 0.5 seconds per day. Therefore, even when the tester indicates an excess of plus 0.5 seconds, because the actual time accuracy will be slightly less than that indicated by the tester when worn on the wrist, it will be within the overage tolerance.

Quartz watches displayed in illuminated show cases will have a higher temperature. When tested with the Quartz tester, the figures may not be stable. Therefore, it should be read after the temperature of the watch becomes stabilized.

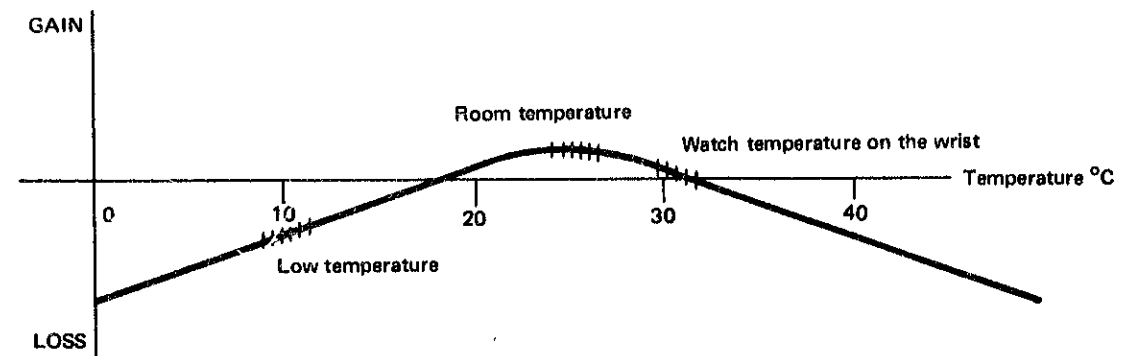

4-2. Time accuracy adjusting method

Time accuracy adjusting is done by replacing the condenser for oscillator regulation.

There are 13 types of regulator condensers, each of a different capacity.

Select the suitable condenser and connect it to the two terminals of the circuit unit.

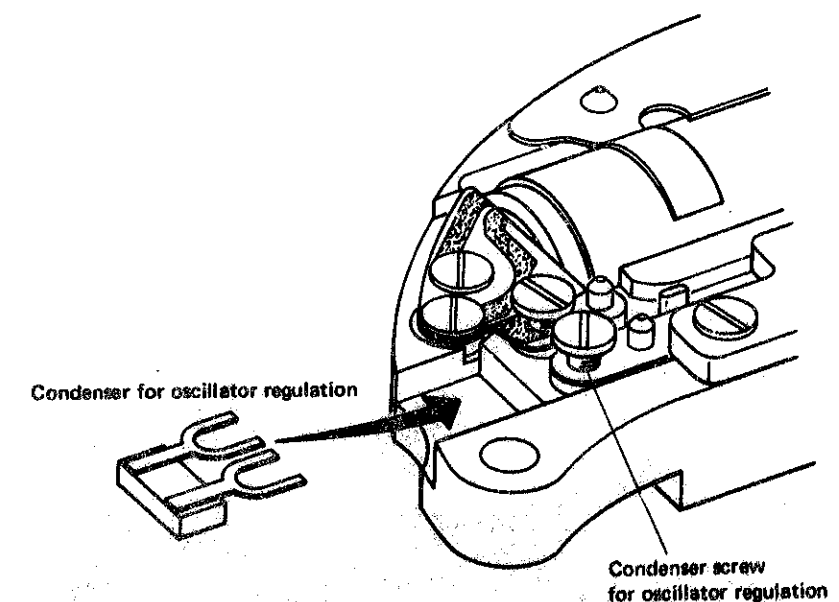

• 13 types of condensers for oscillator regulation

Each condenser has its own number indicated on the back of the condenser. They are as follows:

0 · 1 · 2 · 3 · 4 · 5 · 6 · 7 · 8 · 9 · X · Y · Z



• Number of condensers (Capacity) and Time accuracy

When lower numbered condensers (small capacity) are used, the watch will gain time.
When higher numbered condensers (large capacity) are used, the watch will lose time.

• How to replace condensers for oscillator regulation

1. Loosen the screws and remove the condenser for oscillator regulation. Check the number on the back of the condenser.



2. Select the appropriate condenser based on the fact that each number represents an adjusting rate of approximately plus/minus 0.4 seconds per 24 hours.

3. Insert the new condenser and tighten the screws

Note: Be careful not to short circuit the condenser connecting terminals.

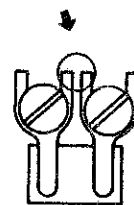

4. Check time accuracy using a Quartz Tester.

1) Specifications

- Casing diameter 25.6 mmφ
- Height 5.3 mm
- Crystal oscillator 16,384 Hz
(Hz = Hertz . . . cycles per second)
- Calendar (date) with instant date setting mechanism
- Second-setting device
- Sub-Hour Hand (with Sub-Hour hand setting device)
- Electronic circuit reset switch
- Loss/gain Loss/gain at normal temperature
Annual rate: less than 2 minutes
(Mean monthly rate: less than 10 seconds)
- Operational temperature range -10°C~+60°C
- Battery power U.C.C. EPX-77 (or 303)
- Dual-Zone Timer has the same mechanical capacity as that of SEIKO Quartz 3803A, having the Sub-Hour Hand device and the Sub-Hour Hand setting device instead of the day setting device of SEIKO Quartz 3803A.

2) Features

SEIKO Quartz Dual-Zone Timer watches feature the "Sub-Hour Hand," which interlocks with the hour-hand, in addition to the ordinary hour, minute and second hands equivalent to those employed in SEIKO Quartz Cal. 3803A. This Sub-Hour Hand can be easily adjusted by turning the crown. By setting the Sub-Hour Hand to the desired local time abroad, you can read both times, the local time from the Sub-Hour Hand and the time of your home country from the hour hand.

3) Disassembly and Assembly

Calendar and Sub-Hour Hand mechanism
Disassemble in the order given by Fig. Nos. ① through ⑰.
Assemble in the reversed order.
For disassembling and assembling of other mechanisms, the procedures are the same as those for Cal. 3803A (see 3803A, Disassembly and Assembly).

Handling Instructions

To set the Sub-Hour Hand

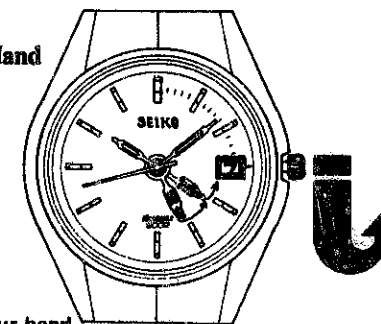

Setting the sub-hour hand

Sub-Hour Hand correcting is made at the first click position of the crown by turning it counterclockwise. Since the Sub-Hour Hand moves at one-hour intervals, adjust it by the time difference between the local time and the time where you stay.

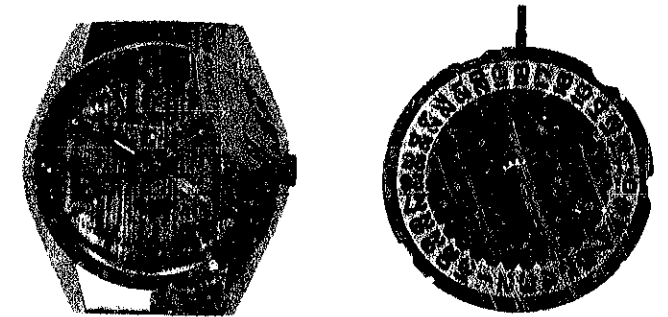

4) Lubrication

Colored symbols in illustrated figures indicate types of oil, quantities to be applied and lubricating points.

Types of oil
● Moebius A

Oil quantity
●●● Liberal quantity
●● Normal quantity
● Extremely small quantity

Calendar Mechanism

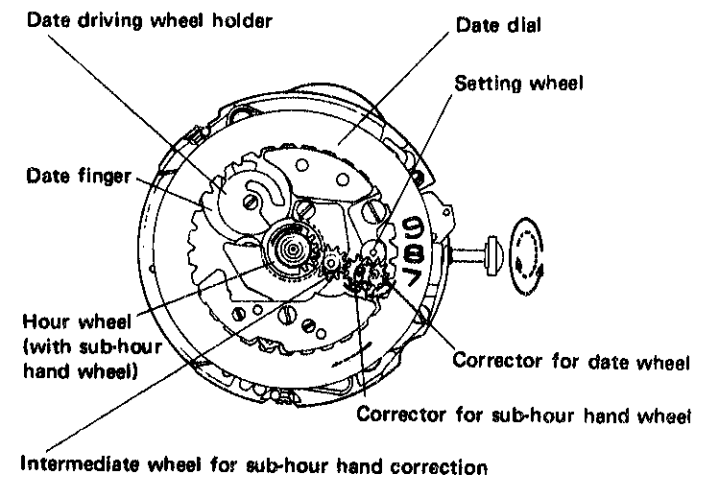

To set the Calendar

Pull the crown out to the first click position and turn it clockwise.

To set the Second Hand and Time

Pull the crown out to the second click position for the second hand setting. Turn the hour hand counterclockwise for the time setting.

Cal. 3819 CALENDAR AND SUB-HOUR HAND MECHANISM

Note:

When effecting the following operations, pull the crown out to the second click position.

- (1) When wipe off dust and chips on dial with hands.
- (2) When disassembling and assembling the hour, minute, second and sub-hour hands.
- (3) When checking turning condition of gear train.

Unless the crown be pulled out to the second click position, the second jumper may be damaged.

Caution when Assembling

- After mounting the dial, check clearance between the dial and hour wheel. (Section A)
- After setting the hands, check clearance between the minute hand tube and hour wheel (Section B), and also clearance between the sub-hour hand and dial. (Section C)

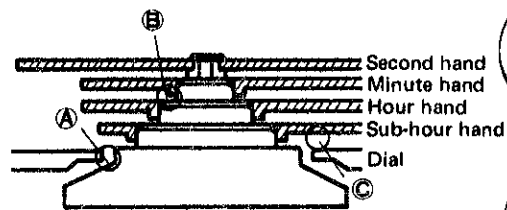

- After pulling the crown out to the third click position and turning the hands, check the calendar changeable zone and clearance of each hand.

- ⑥ Day jumper screw (2 pcs.)
- ⑦ Day jumper
- ⑧ Date dial
- ⑨ Hour wheel guard screw (2 pcs.)
- ⑩ Hour wheel guard

Caution when Disassembling and Assembling

- The hour wheel cannot be disassembled.
- Clear the hour wheel only when the sub-hour hand cannot be corrected or smoothly adjusted. Normally when assembling or disassembling, cleaning the hour wheel is unnecessary. When cleaning the hour wheel, dip it completely in a solution of clean benzine and Moebius Synt-A-Lube (approx. 50 to 1), and let it dry at room temperature before assembling.

- ② Dial screw (2 pcs.)

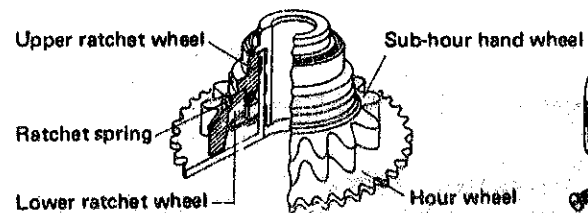

When correcting the sub-hour hand, only the parts marked "shaded" rotates.

Caution when Assembling

- When fitting the sub-hour hand, turn the crown counterclockwise at first click position to stabilize the sub-hour hand wheel, and then change crown to second click position and continue hand-setting until the day indicator settles in the specified position.
- When the sub-hour hand is pushed in, be careful so that the Hand Setting Tool may not strike the hour wheel tube.

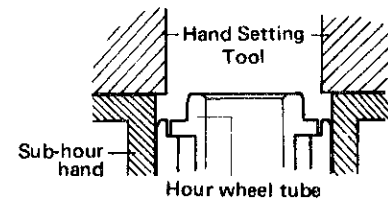

- Then push in the hour hand by aligning the center of sub-hour hand with the center of hour hand.
- The second hand should be set exactly on the even number of the dial.

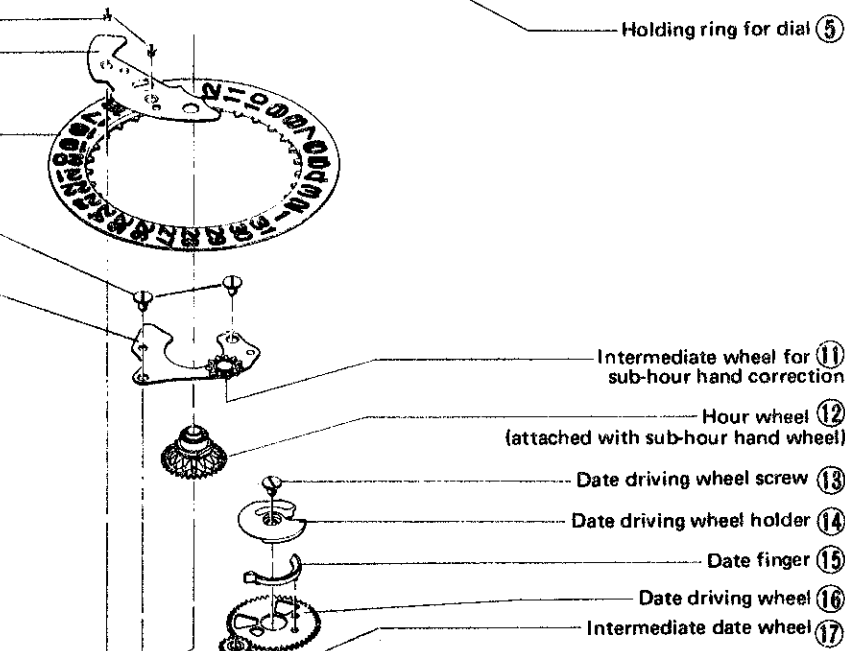
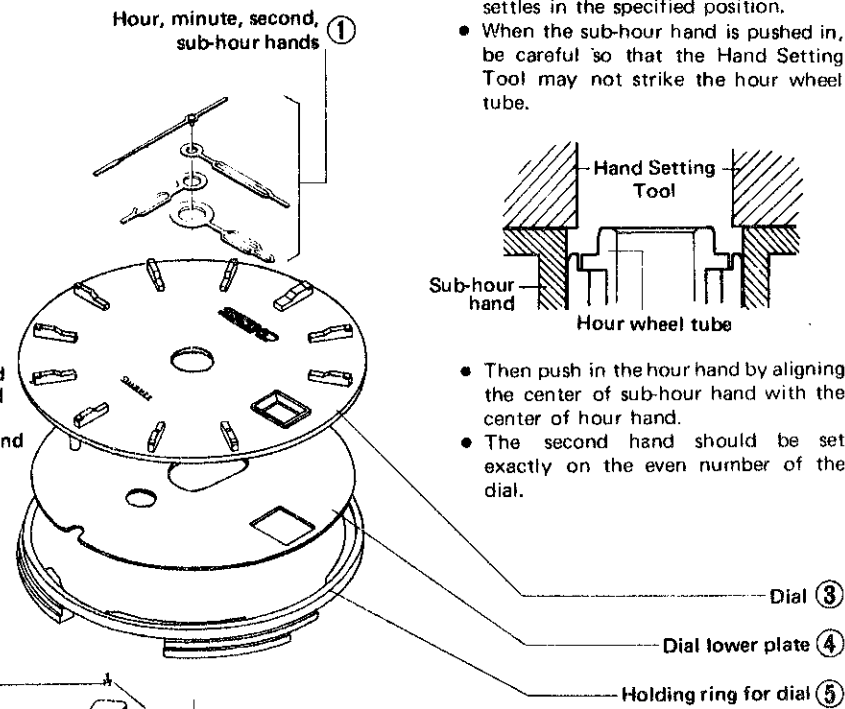

Do not mistake upper and lower side when assembling.

