

**TECHNICAL GUIDE
&
PARTS CATALOGUE**

Cal.VD7 Series
(VD70A/72A/73A/74A/75A/76A/77A/78A/79A)

ANALOGUE QUARTZ

Item		Cal. No.	VD74A							
Movement		<p>*Refer to page 2 for other Cal. No. specifications.</p>								
Movement size	Outside diameter	φ23.70 mm 22.60 mm : between 12 o'clock and 6 o'clock sides 22.60 mm : between 3 o'clock and 9 o'clock sides								
	Casing diameter	φ23.30 mm 22.10 mm : between 12 o'clock and 6 o'clock sides 21.40 mm : between 3 o'clock and 9 o'clock sides								
	Total height	3.45 mm								
Time indication	Cal. No.	VD70A	VD72A	VD73A	VD74A	VD75A	VD76A	VD77A	VD78A	VD79A
	Hands	3	3	4	6	5	5	4	3	4
	2 Hands (hour, minute)	○	○	○	○	○	○	○	○	○
	Small Second hand (6 H)	x	x	○	○	○	○	○	○	x
	24 Hour hand (12 H)	x	x	x	○	x	x	○	x	x
	Date Calendar hand (3 H)	○	x	x	○	○	x	x	x	○
	Date Calendar hand (2 H)	x	○	○	x	x	○	x	x	x
	Day Calendar hand (9 H)	x	x	x	○	○	x	x	x	○
Day Calendar hand (10 H)	x	x	x	x	x	○	x	x	x	
Driving system	Step motor									
Additional mechanism	Electronic circuit reset switch Second setting device Date setting									
Antimagnetic	≥ 1600 A/m									
Accuracy	Less than ± 20 seconds : Monthly rate at normal temperature range									
Battery	SR626SW (Silver oxide battery) Battery life is approximately 3 years									
Measuring gate by quartz tester	Use 10 second gate * Set the winding stem with crown at the normal position									
Jewels	0 Jewel									

VD70A

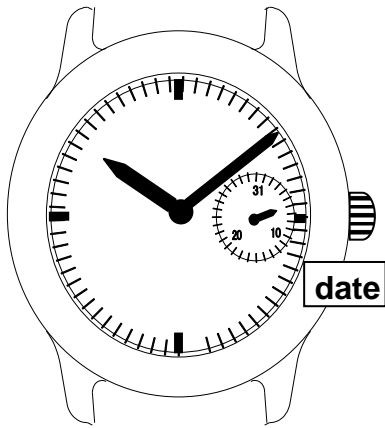

VD72A

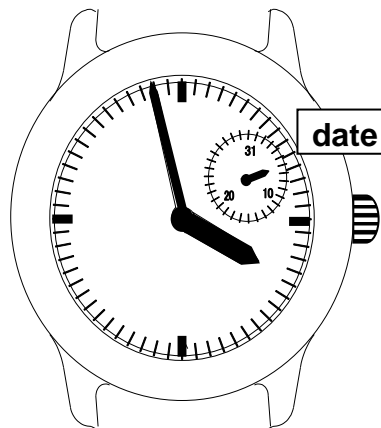

VD73A

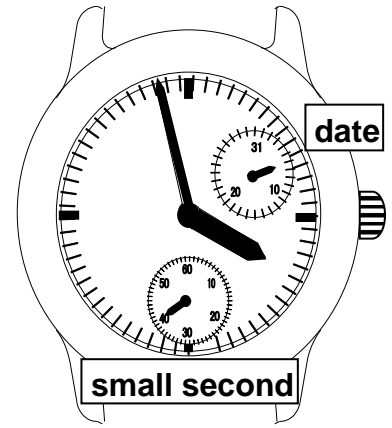

VD74A

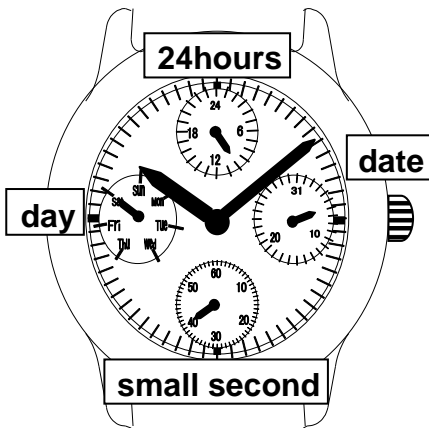

VD75A

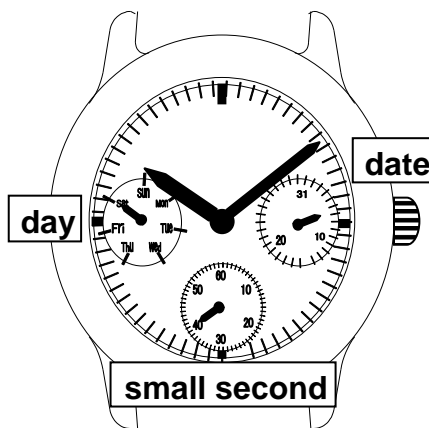

VD76A

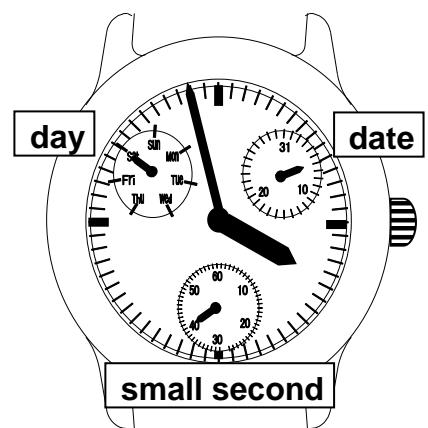

VD77A

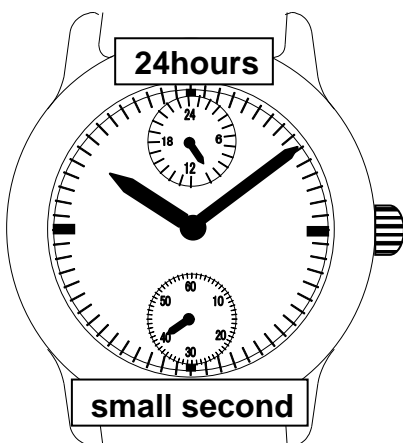

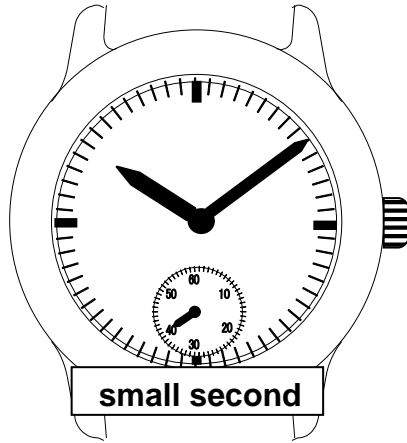

VD78A







VD79A

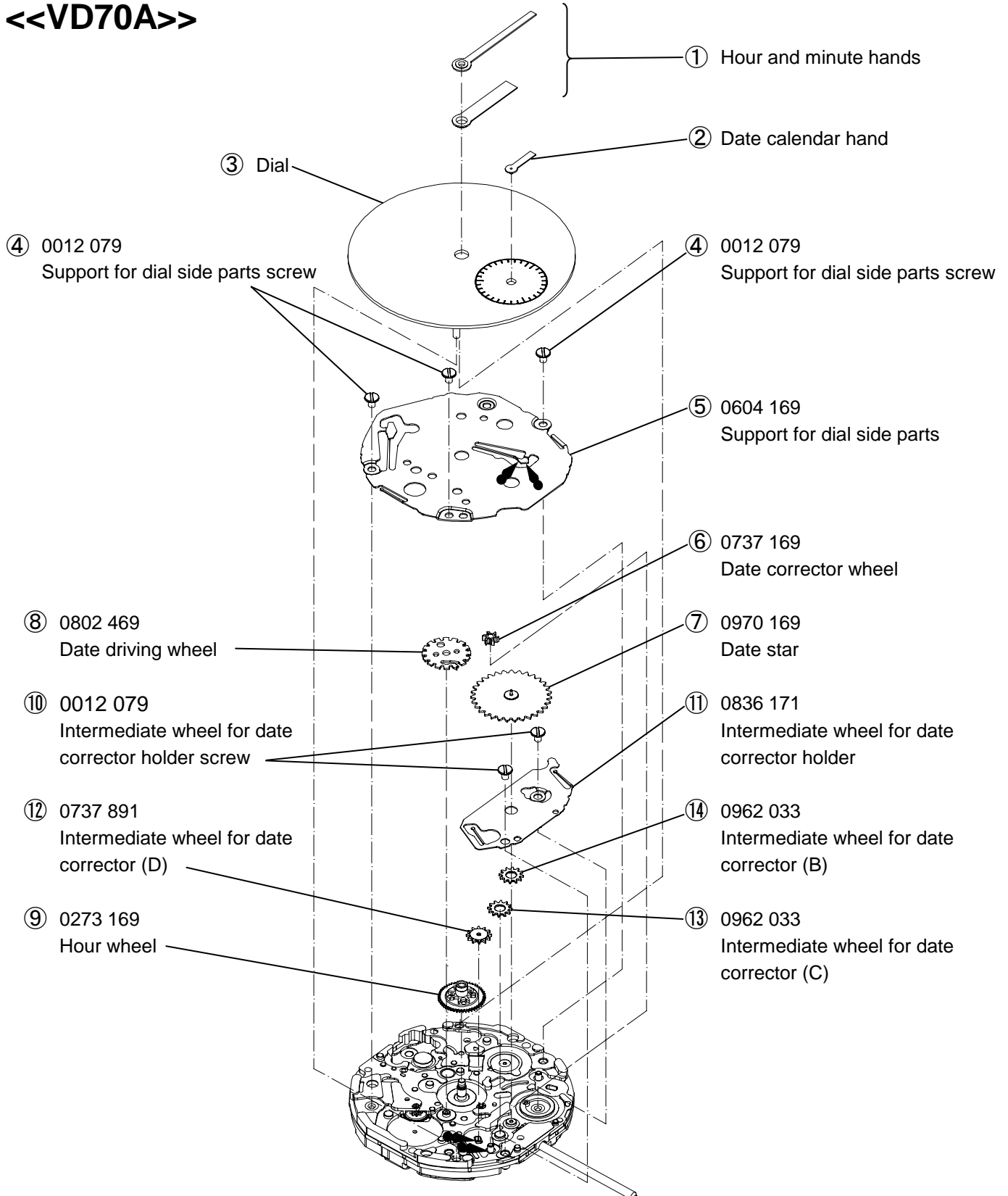

Disassembling procedures Figs. ① → ④②	Lubricating : Types of oil	 A3a / Moebius 9010
		 A2a / Moebius 9030
Reassembling procedures Figs. ④② → ①	Oil quantity	 Normal quantity



<<VD70A>>



Disassembling procedures Figs. ① → ④②	Lubricating : Types of oil  A3a / Moebius 9010  A2a / Moebius 9030
Reassembling procedures Figs. ④② → ①	
Oil quantity	 Normal quantity

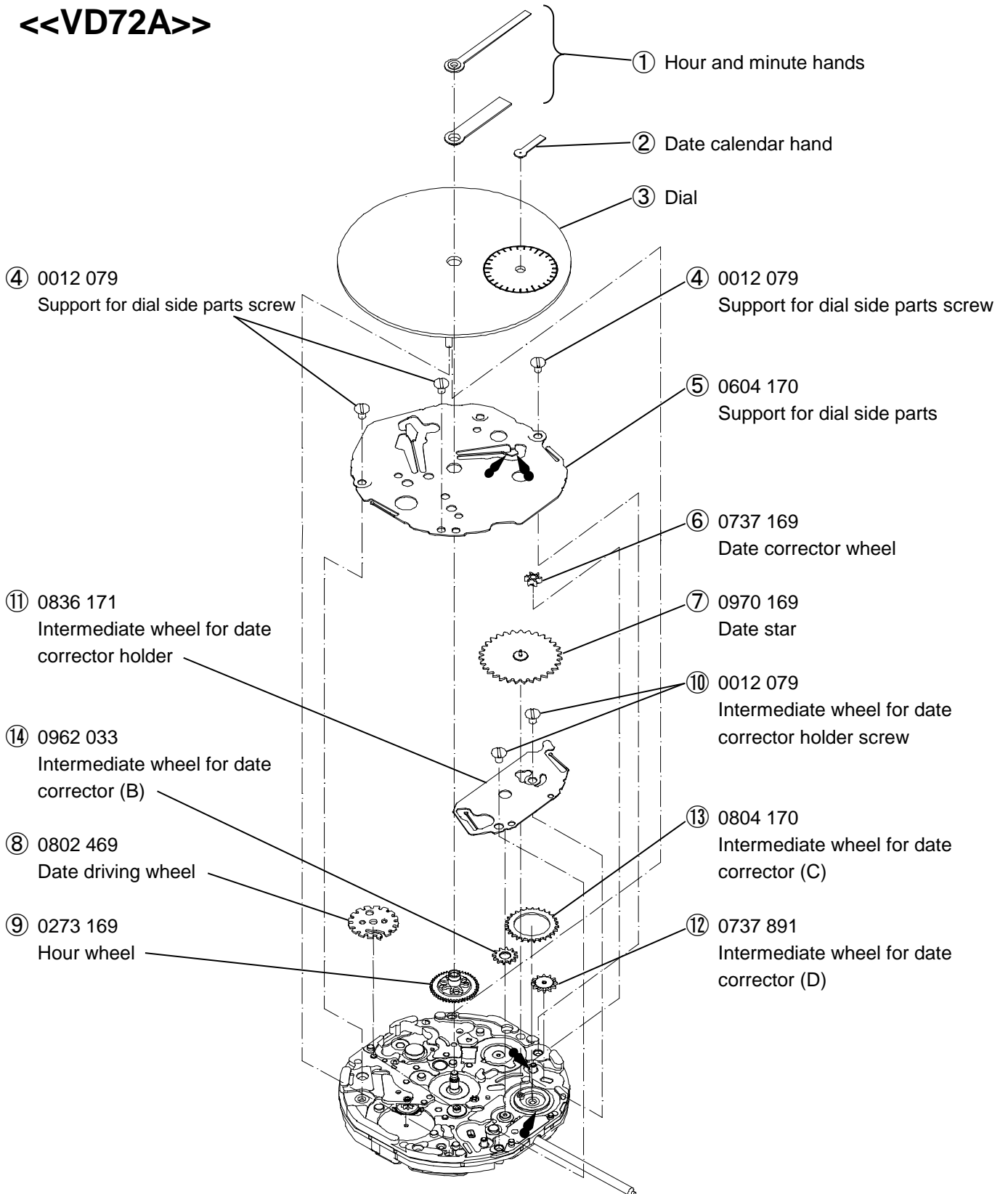

<<VD72A>>



Disassembling procedures Figs. ① → ④②	Lubricating : Types of oil  A3a / Moebius 9010  A2a / Moebius 9030
Reassembling procedures Figs. ④② → ①	
	Oil quantity  Normal quantity

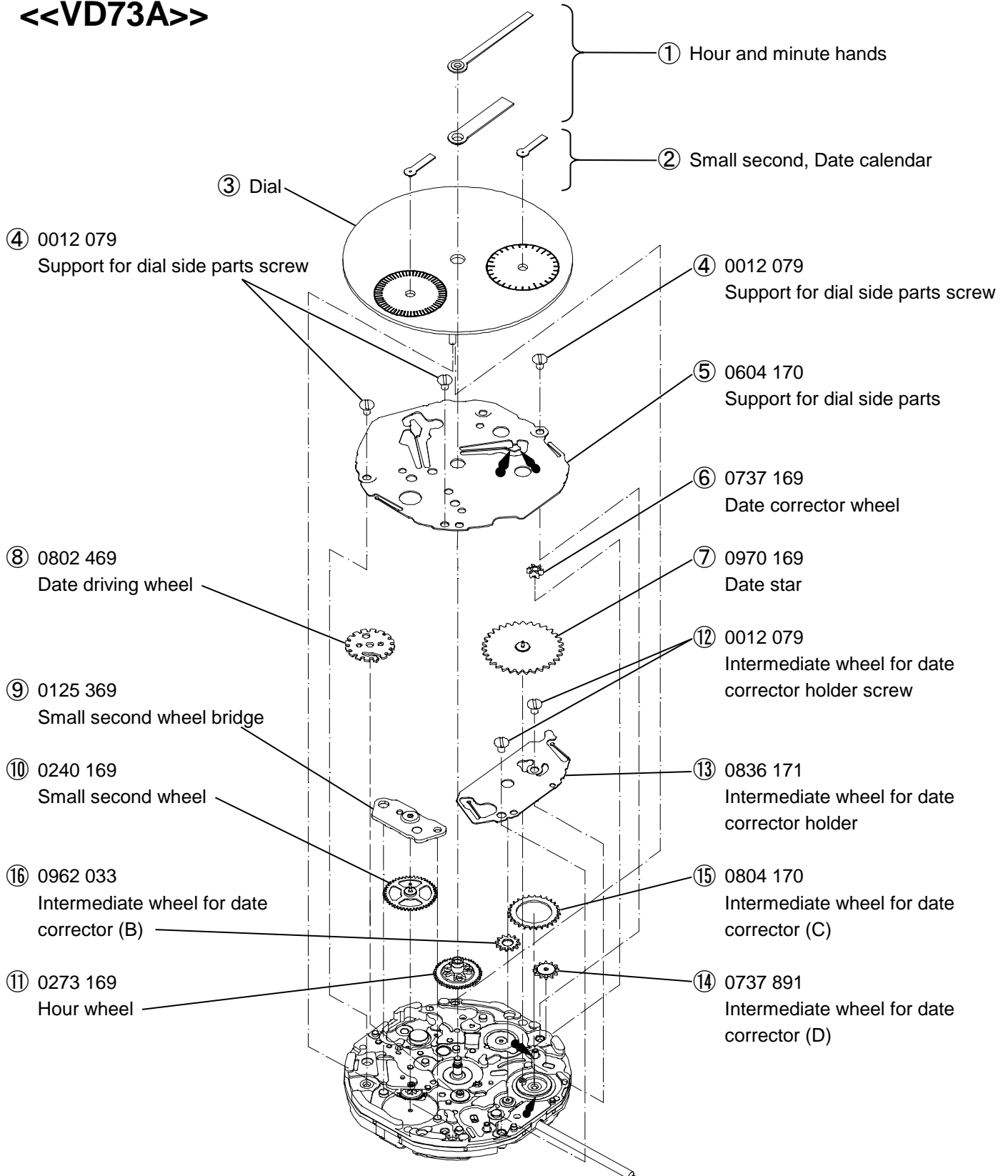

<<VD73A>>



Disassembling procedures Figs. ① → ④②	Lubricating : Types of oil  A3a / Moebius 9010  A2a / Moebius 9030
Reassembling procedures Figs. ④② → ①	
Oil quantity	 Normal quantity

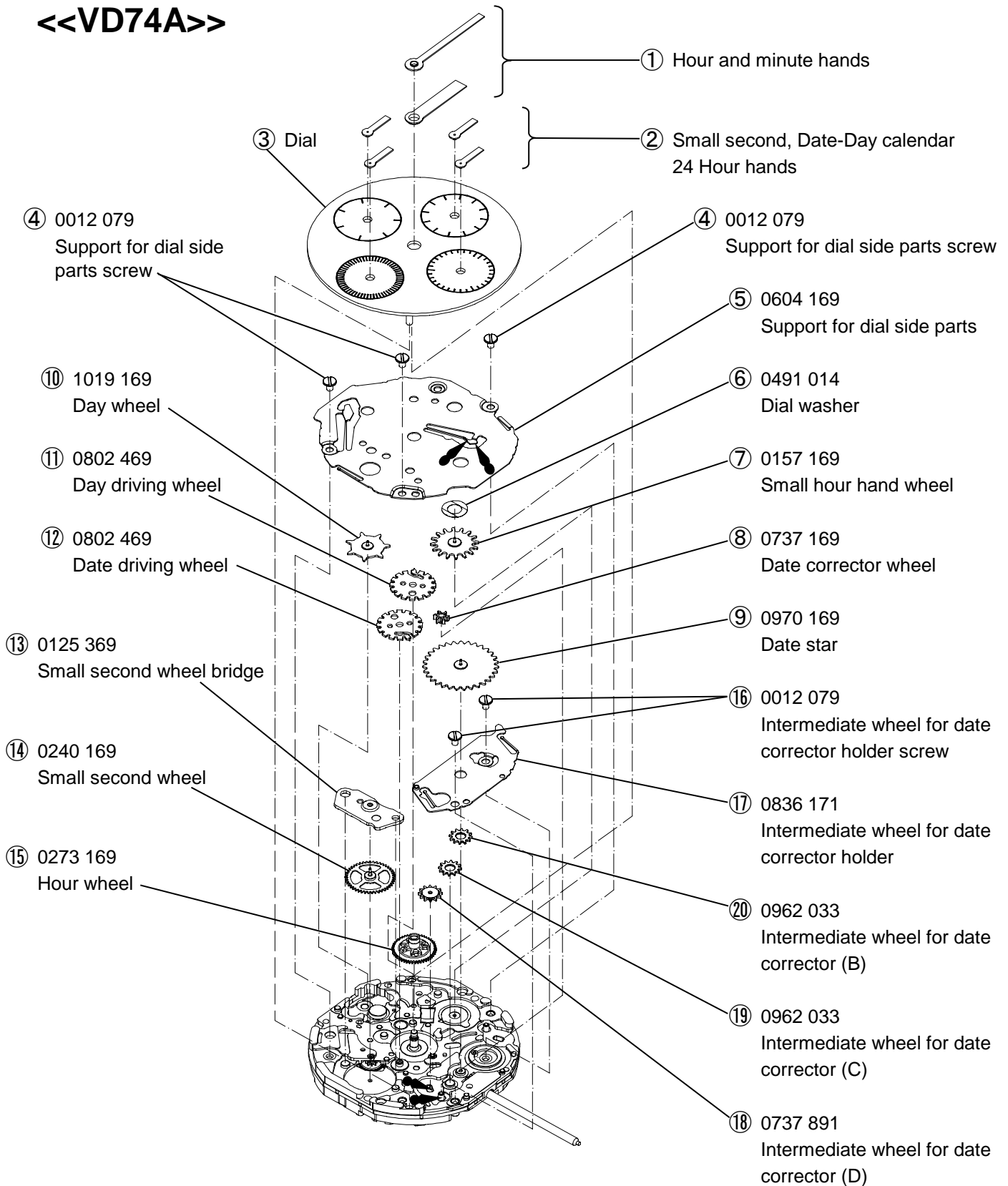

<<VD74A>>



Disassembling procedures Figs. ① → ④②	Lubricating : Types of oil  A3a / Moebius 9010  A2a / Moebius 9030
Reassembling procedures Figs. ④② → ①	
	Oil quantity  Normal quantity

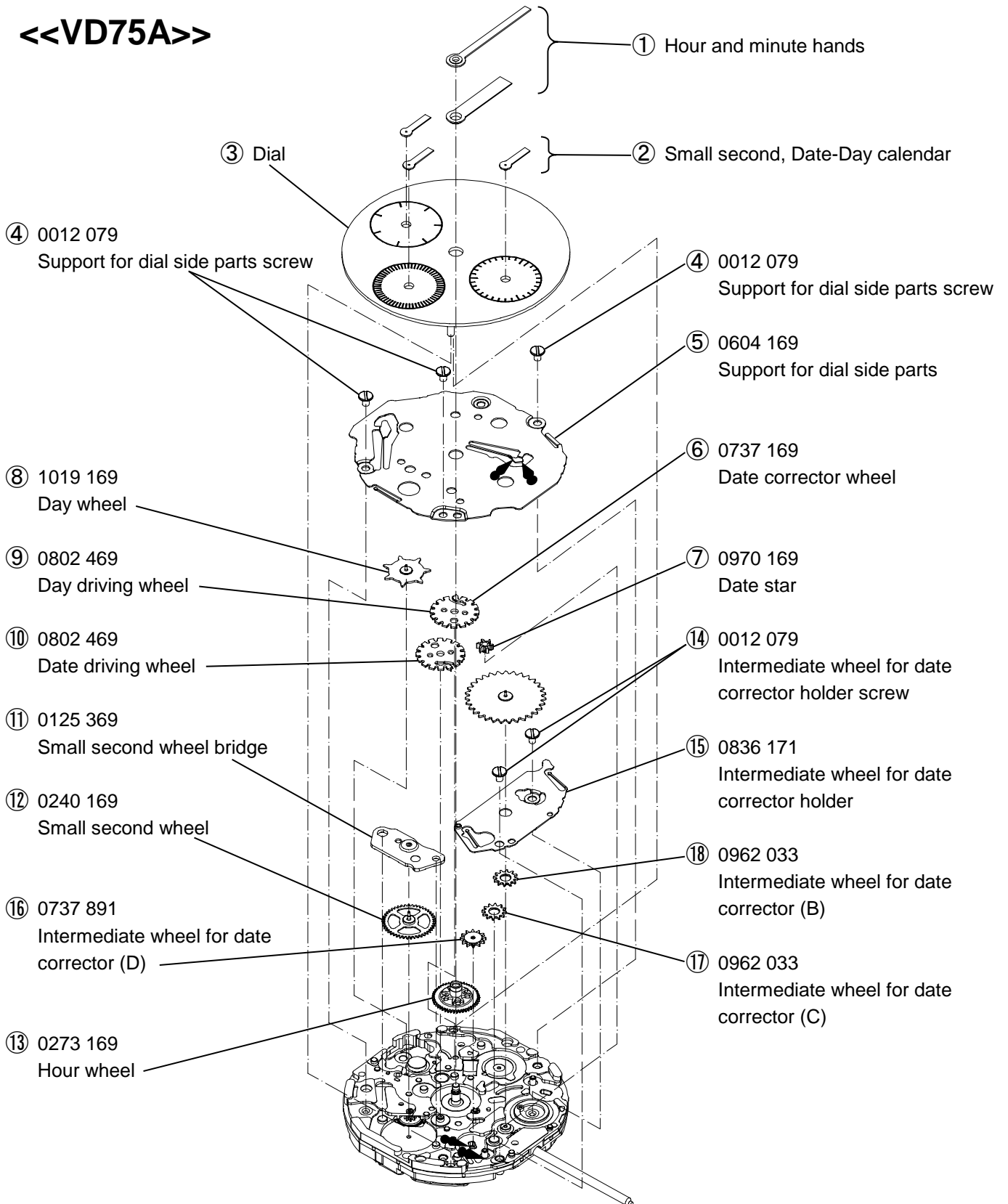

<<VD75A>>



Disassembling procedures Figs. ① → ④②	Lubricating : Types of oil	 A3a / Moebius 9010
		 A2a / Moebius 9030
Reassembling procedures Figs. ④② → ①	Oil quantity	 Normal quantity

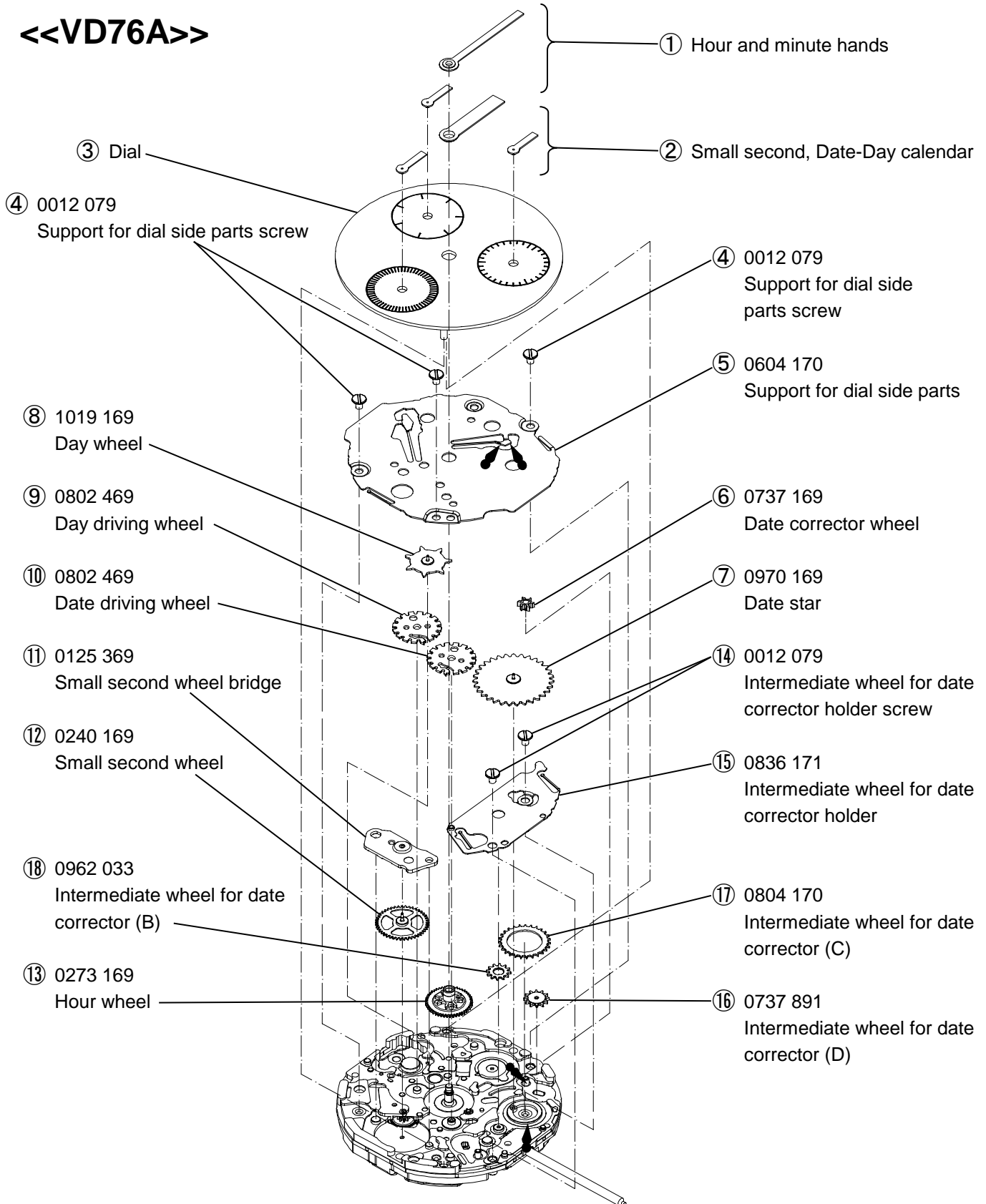

<<VD76A>>



Disassembling procedures Figs. ① → ④②	Lubricating : Types of oil  A3a / Moebius 9010  A2a / Moebius 9030
Reassembling procedures Figs. ④② → ①	
	Oil quantity  Normal quantity

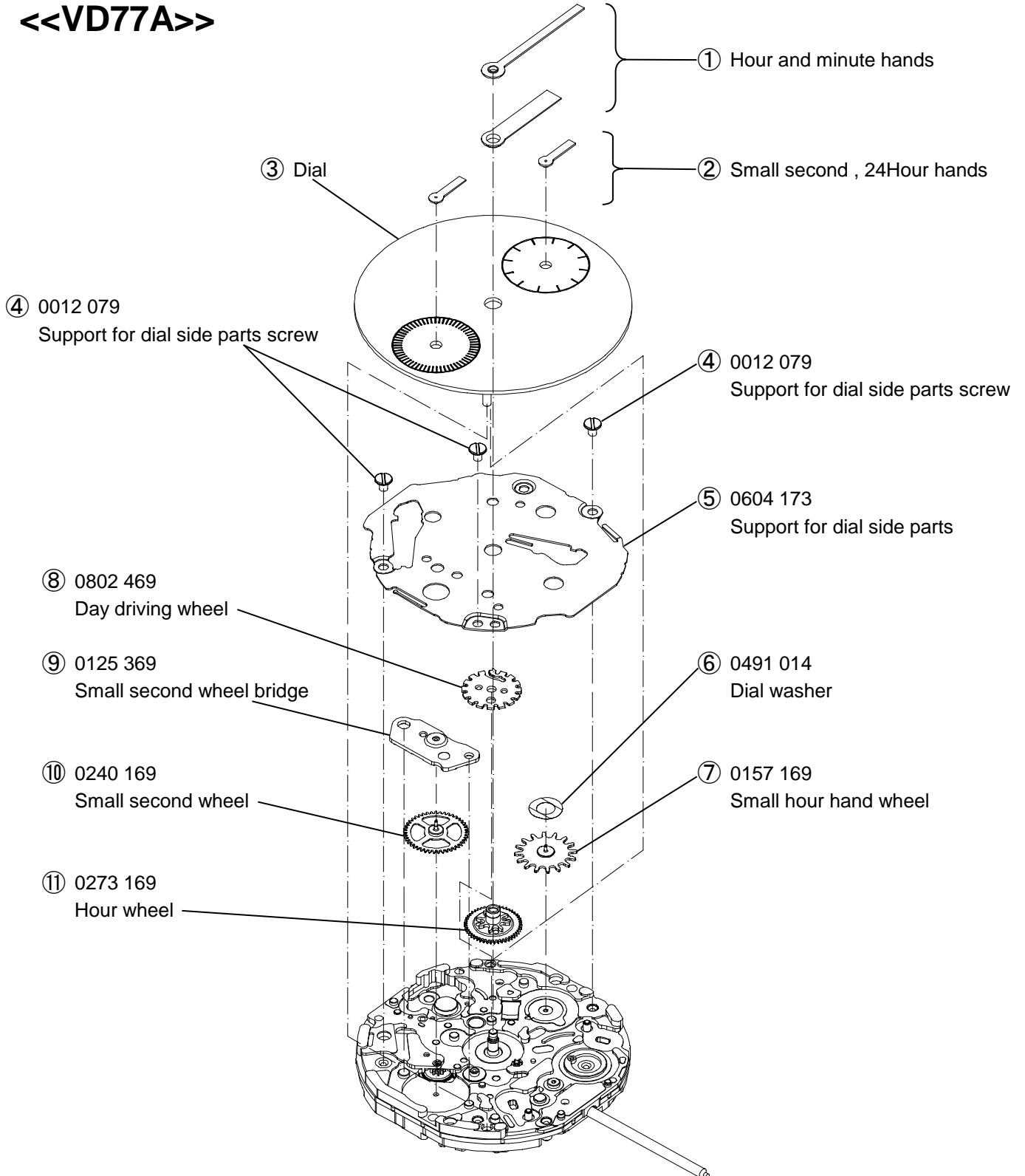

<<VD77A>>

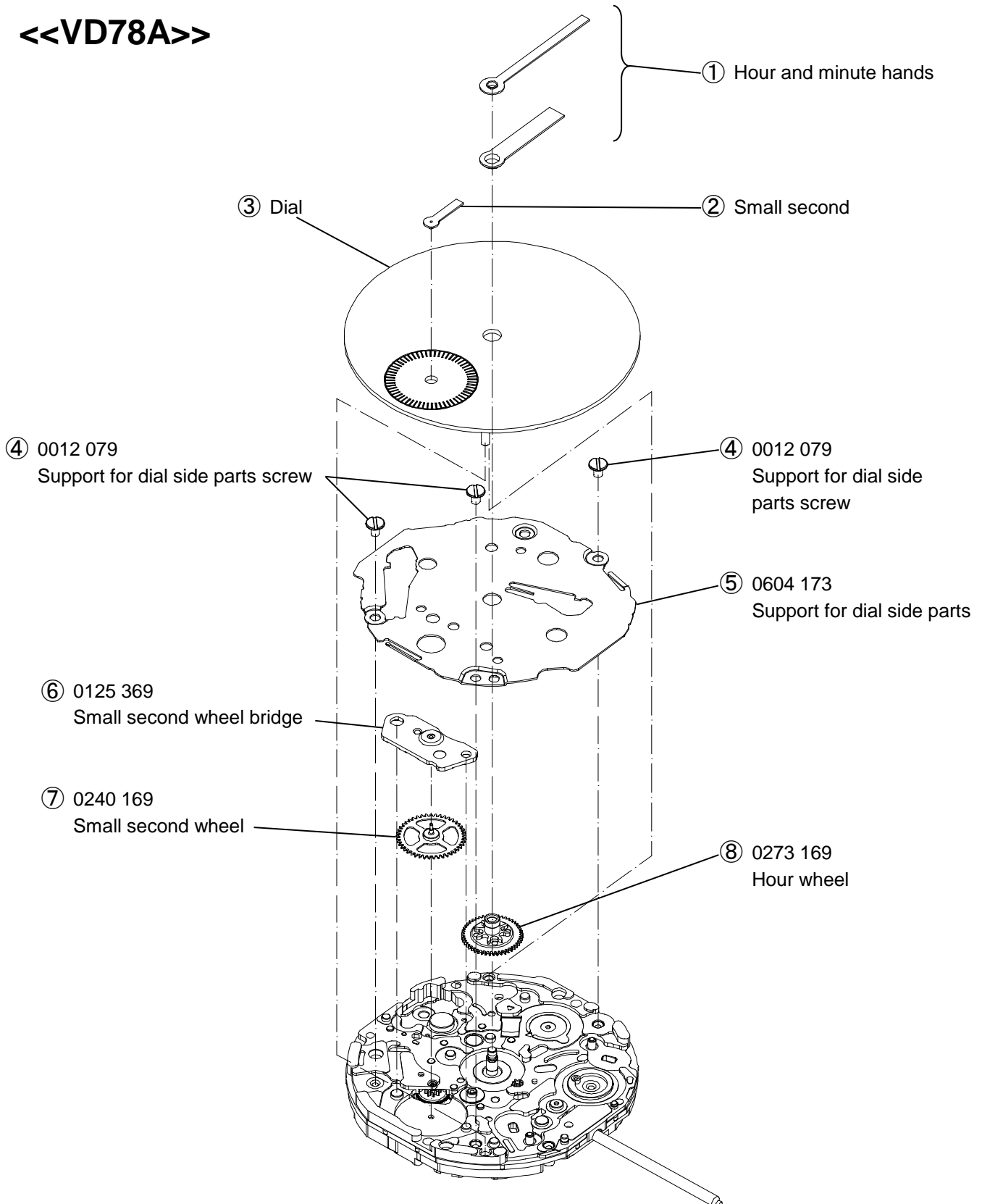

Disassembling procedures Figs. ① → ④②	Lubricating : Types of oil  A3a / Moebius 9010  A2a / Moebius 9030
Reassembling procedures Figs. ④② → ①	
	Oil quantity  Normal quantity

<<VD78A>>



Disassembling procedures Figs. ① → ④②	Lubricating : Types of oil	 A3a / Moebius 9010
		 A2a / Moebius 9030
Reassembling procedures Figs. ④② → ①	Oil quantity	 Normal quantity

<<VD79A>>

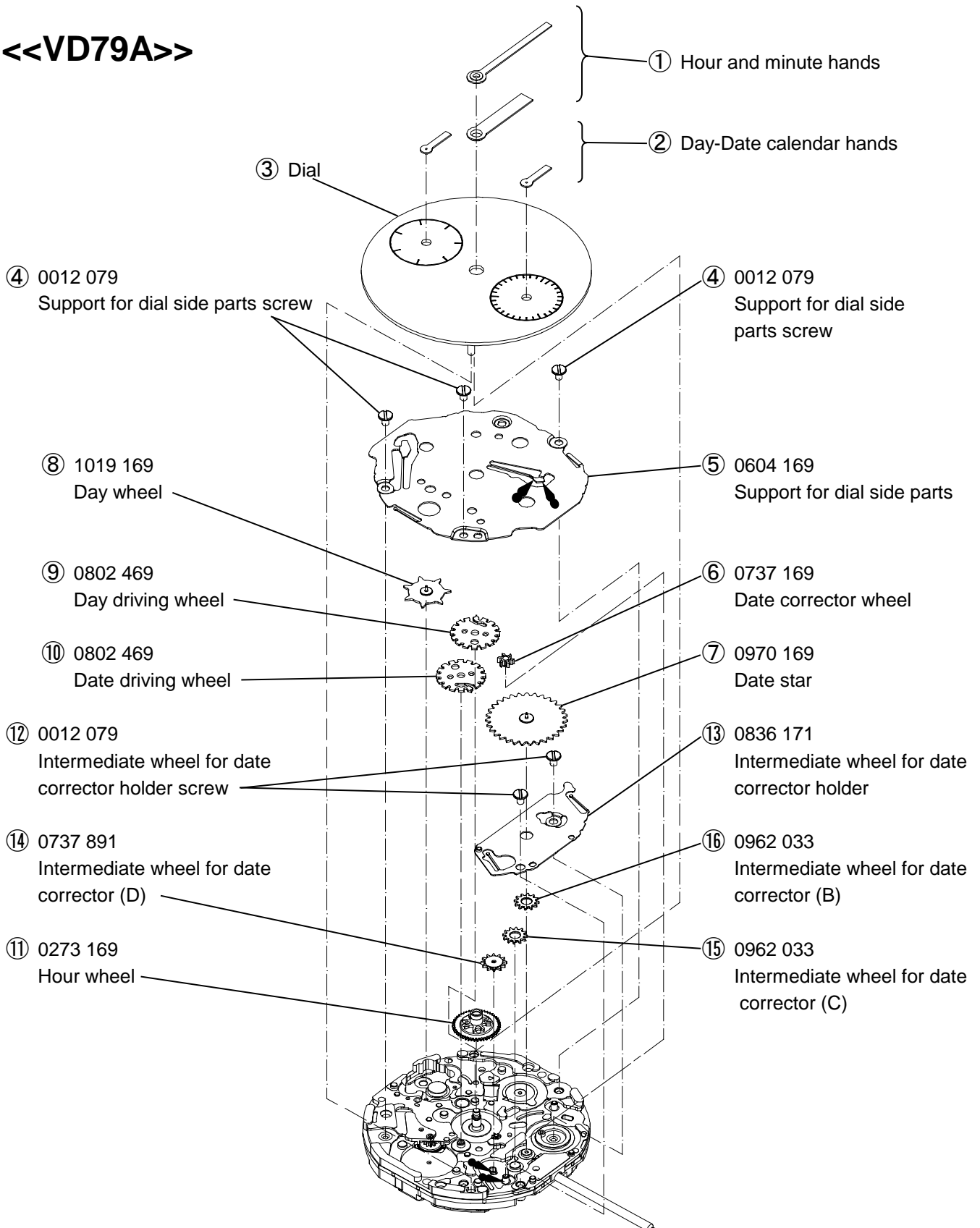

Disassembling procedures Figs. ① → ④②	Lubricating : Types of oil	
		A3a / Moebius 9010
Reassembling procedures Figs. ④② → ①		A2a / Moebius 9030
	Oil quantity	Normal quantity

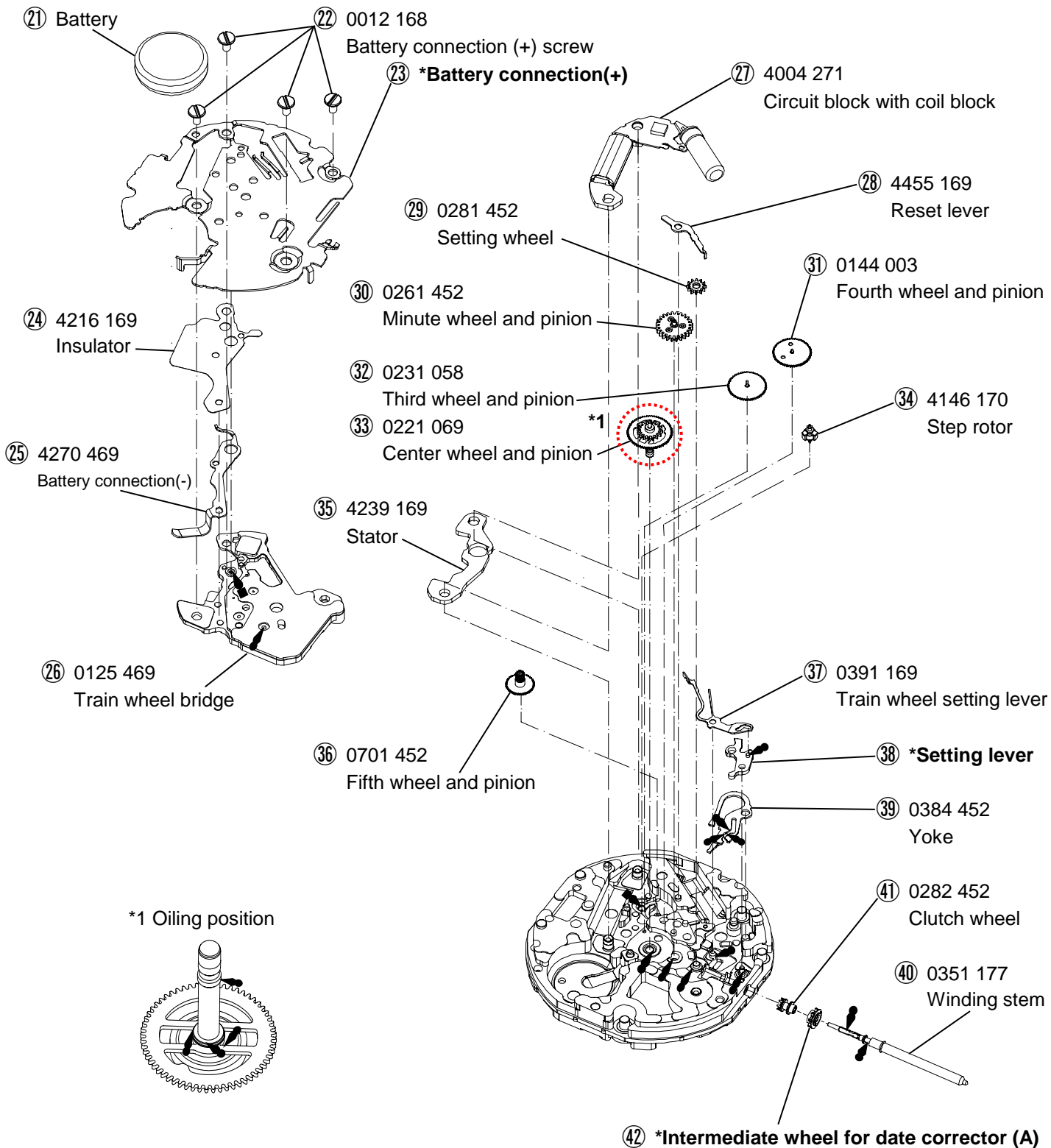

*Refer to page 13 for each parts code

Remarks:

O Different parts for each CAL.

Parts name	Parts code	VD70A	VD72A	VD73A	VD74A	VD75A	VD76A	VD77A	VD78A	VD79A
Setting lever	0383 891	O	O	O	O	O	O	—	—	O
	0383 154	—	—	—	—	—	—	O	O	—
Battery connection(+)	4271 470	—	—	—	O	—	—	—	—	—
	4271 471	—	—	—	—	O	—	—	—	—
	4271 472	—	—	—	—	—	O	—	—	—
	4271 473	—	—	—	—	—	—	O	—	—
	4271 474	—	—	—	—	—	—	—	O	—
	4271 475	—	—	—	—	—	—	—	—	O
	4271 490	—	O	—	—	—	—	—	—	—
	4271 492	—	—	O	—	—	—	—	—	—
4268 089	O	—	—	—	—	—	—	—	—	
Intermediate wheel for date corrector (A)	0804 169	O	O	O	O	O	O	—	—	O

*** All parts code are subject to change without notice.**

• The explanation here is only for the particular point of Cal.VD70A/VD72A/VD73A/VD74A/VD75A/VD76A /VD77A/VD78A/VD79A

REMARKS ON DISASSEMBLING AND REASSEMBLING

(1) Hand

• How to install hands

Place the movement directly on a flat metal plate or the like to install the hands.

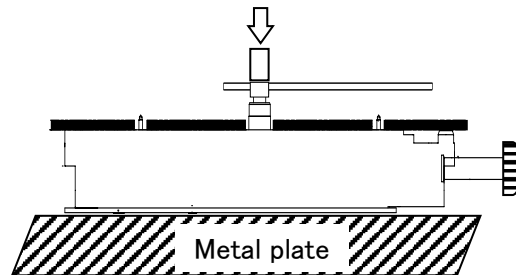

Note: How to procedure hands

① Dial setting.

② Install the date calendar and small second hands at the 12 o'clock position.

③ Pull out the crown to the second click position and rotation it clockwise the change date.

④ Install the day calendar and 24 hour and hour and minute hands at the 12 o'clock position.

• Cal.VD77A install the 24 hour hand

Pull out the crown to the second click position and rotation it clockwise to install 24 hour hand.

※ Cal.VD77A and VD78A not day-date calendar hands

(2) Winding stem

• How to remove

While pushing the indented portion of the arrow pull out the winding stem.

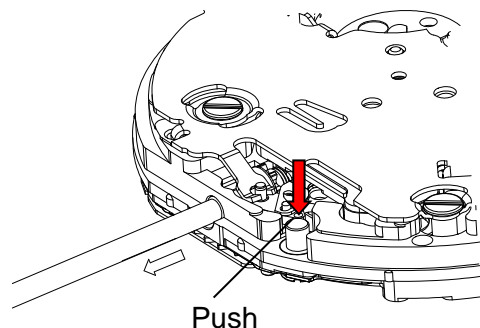

(3) Battery

• How to install

Insert the battery aslant in the direction shown by the arrow. Check the battery connection (+) securely touches the side face of the battery.

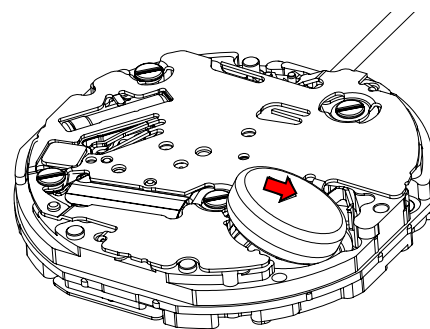

(4) Insulator

Notes: To insulate between the battery connection (+) and the battery connection (-), the insulator should put at the three pin securely as bellow.

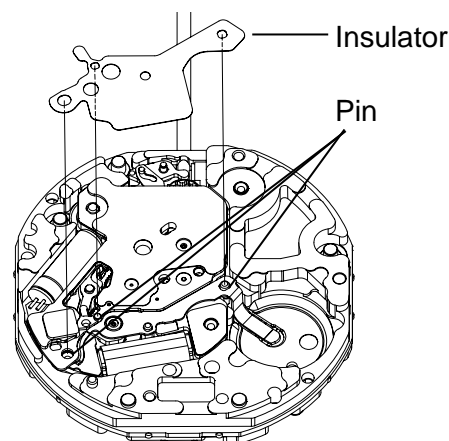

(5) Setting position (Notes at the time of disassembling and a reassembling)

· How to set the Date & Day driving wheels in the correct position

Note:

Set the indicator finger of a Date & Day driving wheels to the setting position mark on the Main plate.
Setting adjustment is not necessary for VD70.

« Cal.VD74A·VD75A·VD79A setting position »

« Cal.VD76A setting position »

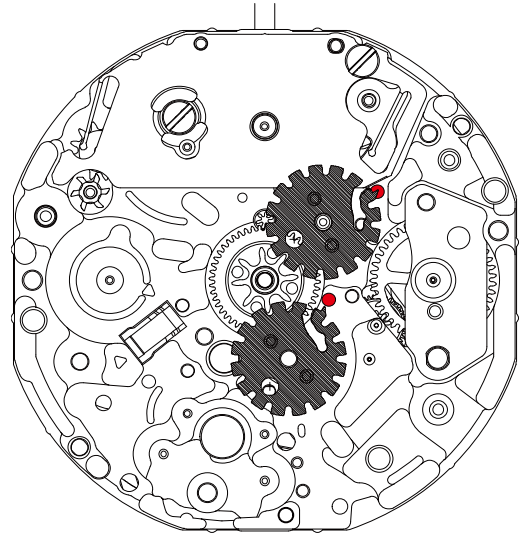
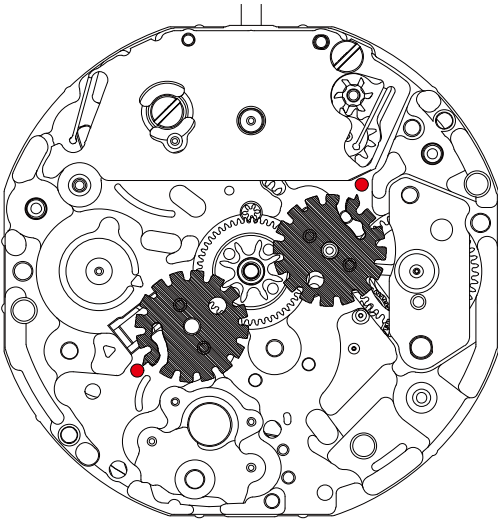

Enlargement

Enlargement

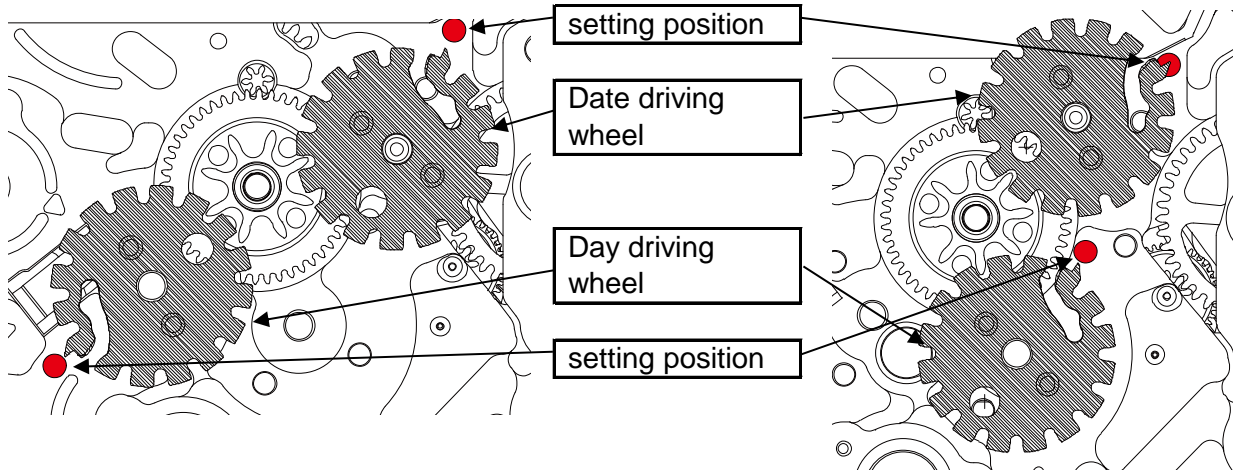

DISPLAY AND CROWN OPERATION

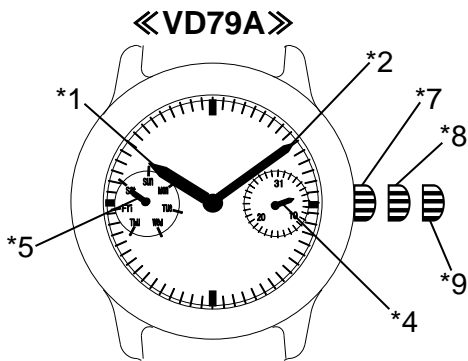
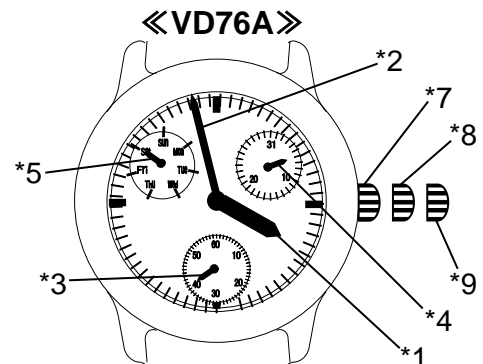
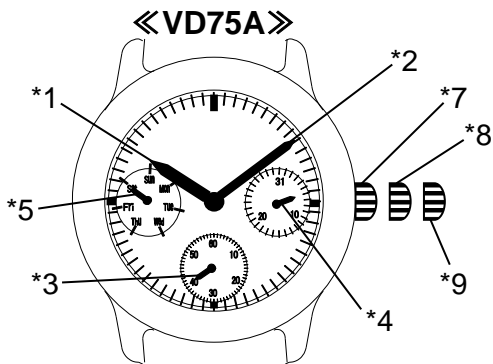
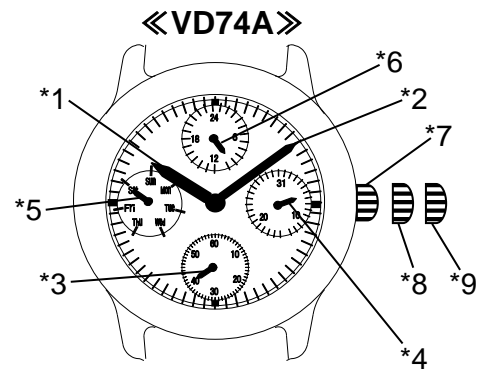
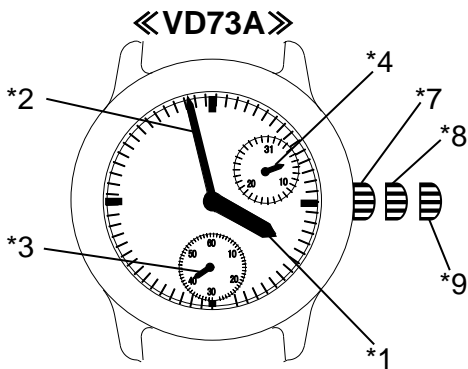
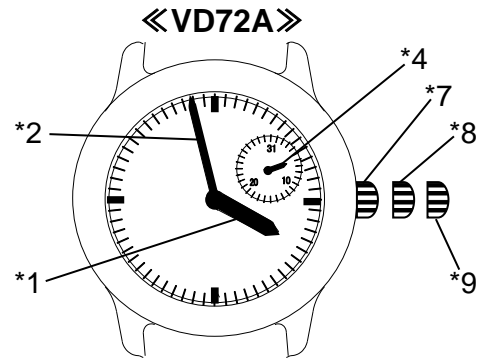
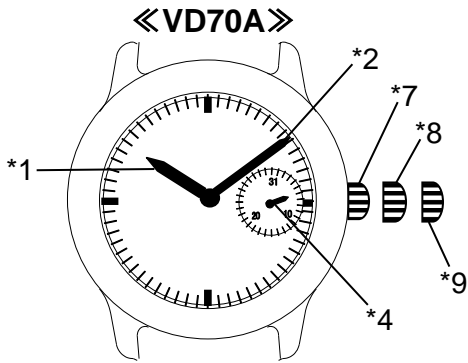

Note:

- | | | | |
|-----------------------|------------------------|---------------------------------------|------------------|
| *1: Hour hand | *4: Date calendar hand | *7: Crown at normal position | *9: Second click |
| *2: Minute hand | *5: Day calendar hand | *8: First click | •Time setting |
| *3: Small second hand | *6: 24 Hour hand | •Date setting (Quick change function) | |

TIME SETTING

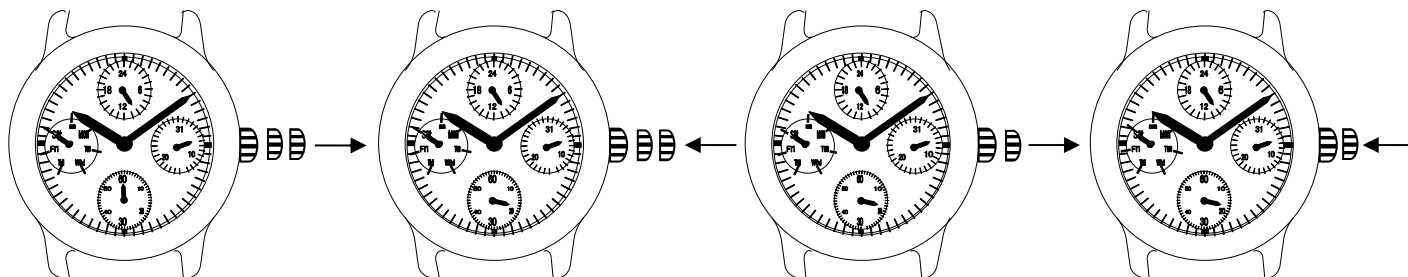

1.Pull out the crown to the second click when the small second hand is at the 12 O'clock position.

2.Push the crown back in to the normal position in signal.
Pull out the crown to the first click .

3.Pull out the crown to the first click.
turn the crown counter-clockwise to set the date.
(Quick change function)

4.Push the crown back in to the normal position.

Turn the crown rotation to set the day of the week.

Turn the crown to set the hour and minute hands to the time.

(Check that AM / PM is set correctly)

*Do not set the date between 10:00 PM and 2:00 AM

Otherwise, the day may not change properly. If it is necessary to set the date during that time period, First change the time to any time outside it, set the date and then reset the correct time.

DISPLAY AND CROWN OPERATION

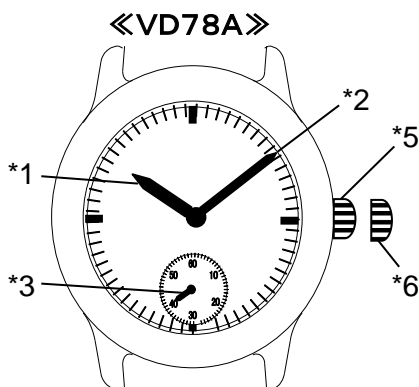
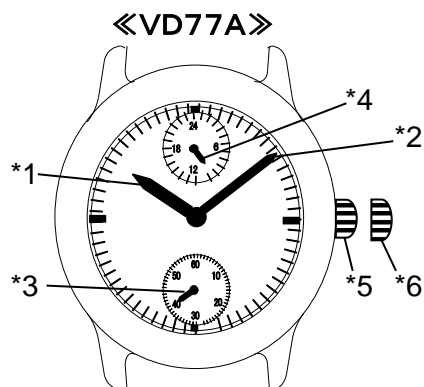

Note:

- *1: Hour hand
- *2: Minute hand
- *3: Small second hand
- *4: 24 Hour hand
- *5: Crown at normal position
- *6: First click
 - Time setting

TIME SETTING

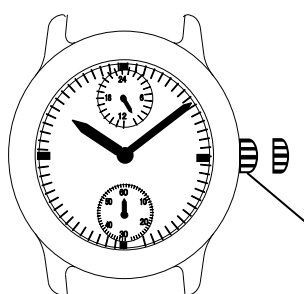

Crown

1. pull out the crown to the first click when the small second hand is at the 12 O'clock position.

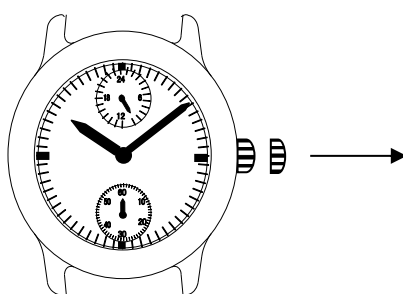

2. Turn the crown to set the hour and minute hands to the time. (Check that AM / PM is set correctly)

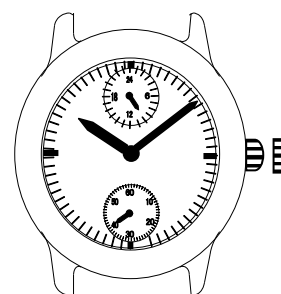

3. Push the crown back in to the normal position in accordance with a time signal.