

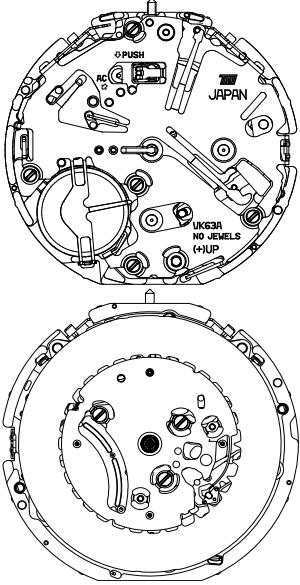

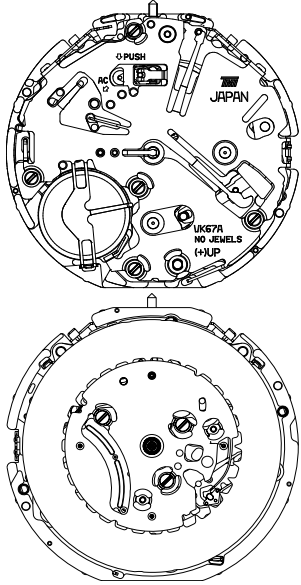

**TECHNICAL GUIDE**  
**&**  
**PARTS CATALOGUE**  
  
**Cal.VK6 Series**  
**(VK63A/67A)**  
  
**ANALOGUE QUARTZ**



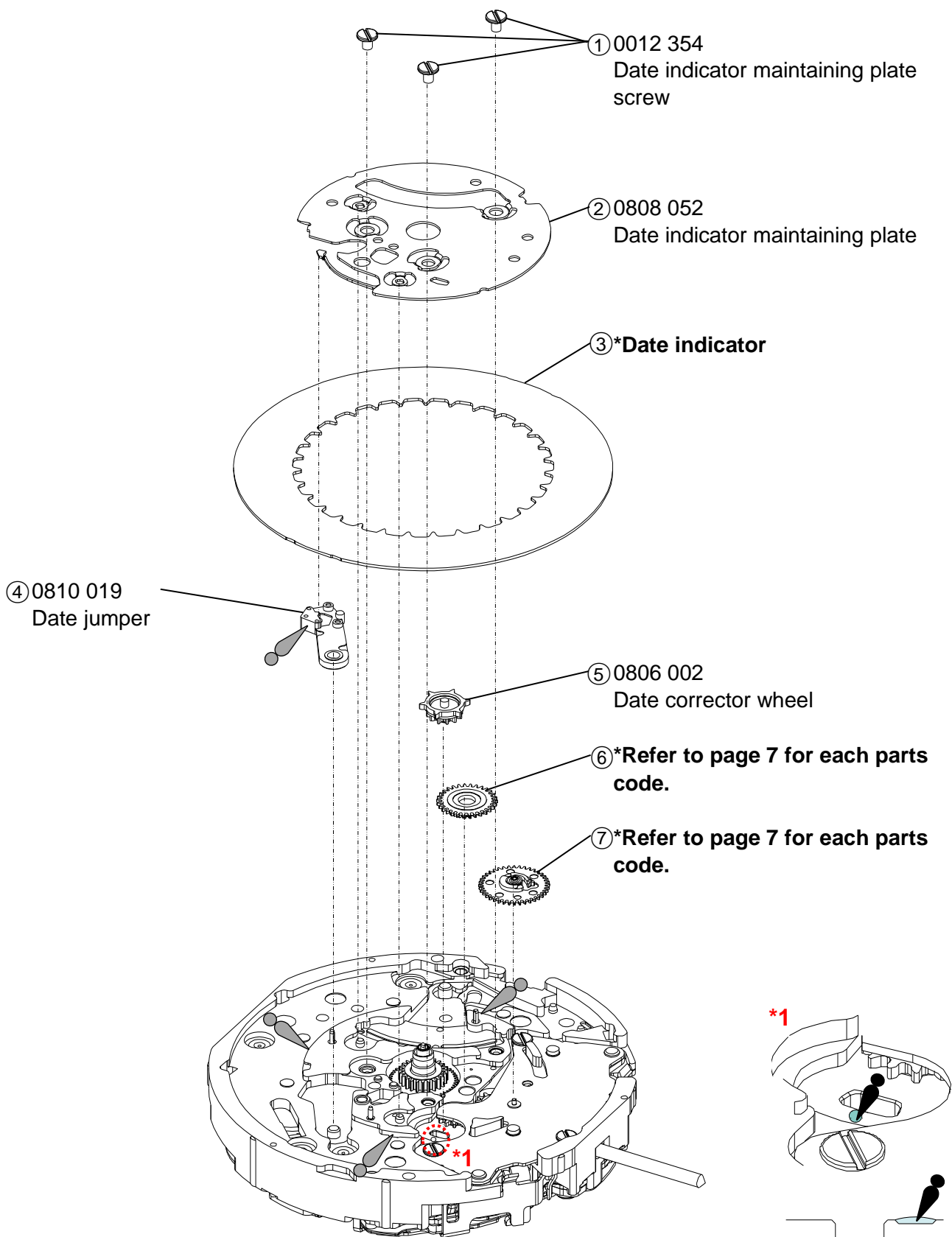

Cal. No.		VK63A	VK67A
Item			
Movement			
Movement size	Outside diameter	φ30.80 mm × 29.10 mm ( 3H - 9H )	
	Casing diameter	φ29.00 mm	
	Total height	5.10 mm	
Time indication	2 Hands (hour, minute)	○	○
	Date Calendar	○	○
	Small second hand ( 6H )	○	○
	Center chronograph ( 1/5 second )	○	○
	60 minutes counter ( 12H )	-	○
	60 minutes counter ( 9H )	○	-
	12 hours counter ( 9H )	-	○
	24 hour indicator ( 3H )	○	-
Driving system	Two pole stepping motor Step motor 2 pieces		
Additional mechanism	Date display with quick correction Electronic circuit reset switch Time setting with stop-second		
Accuracy	Less than ± 20 seconds : Monthly rate at normal temperature range		
Battery	SR936SW (Silver oxide battery ) Battery life is approximately 3 years (60 minutes chronograph operation per day)		
Measuring gate by quartz tester	Use 10 second gate *Set the winding stem with crown at the normal position		
Antimagnetic	≥ 1600 A/m		
Jewels	0 Jewel		

Disassembling procedures Figs. ① → ⑥2	Lubricating : Types of oil		A3a / Moebius 9010
Reassembling procedures Figs. ⑥2 → ①	Oil quantity		A2a / Moebius 9030
			Normal quantity
			Sufficient quantity





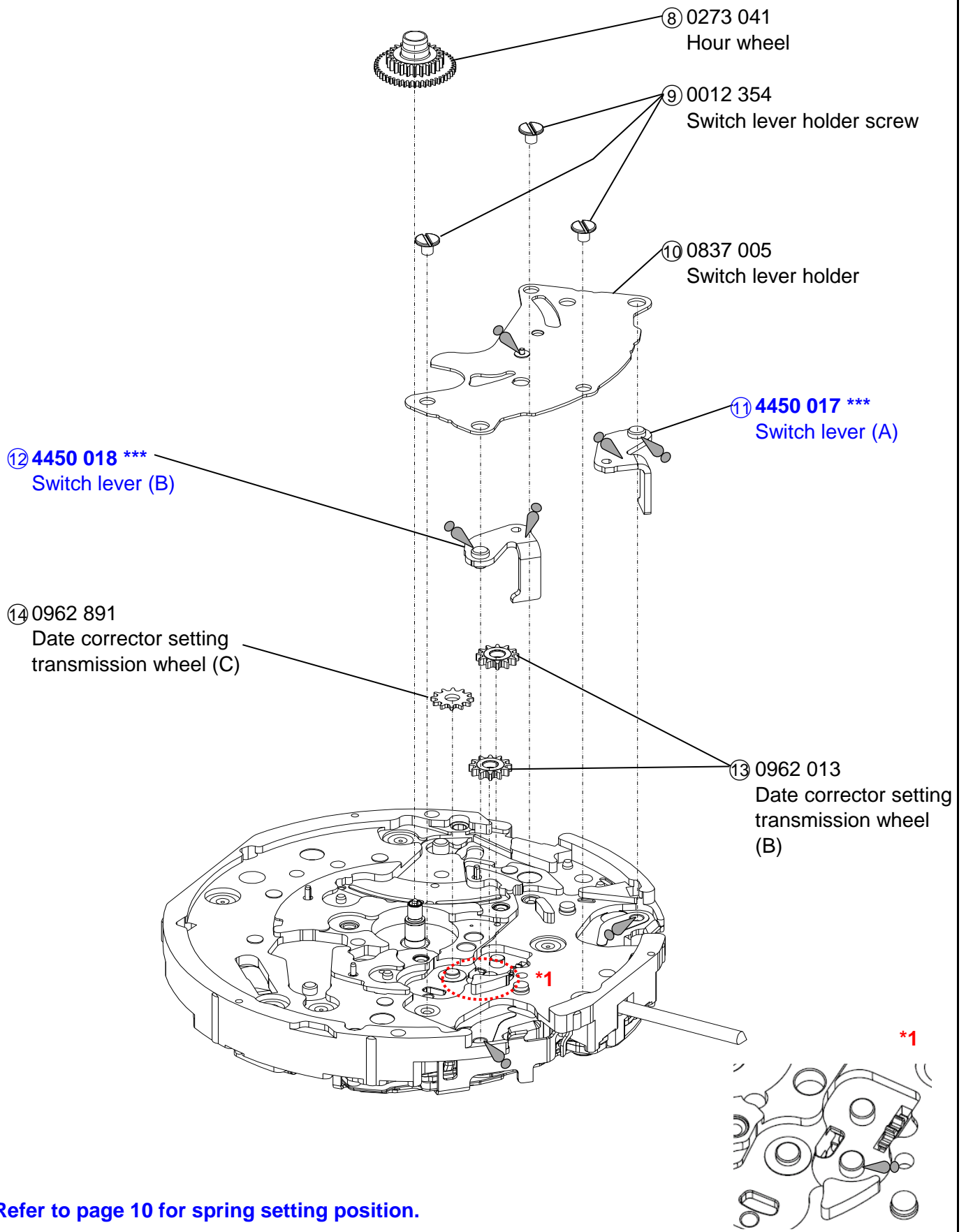

\*Refer to page 7 for each parts code.

[ Cross section ]

Disassembling procedures Figs. ① → ⑥②	Lubricating : Types of oil		A3a / Moebius 9010
Reassembling procedures Figs. ⑥② → ①	Oil quantity		A2a / Moebius 9030
			Normal quantity
			Sufficient quantity



\*\*\* Refer to page 10 for spring setting position.

Disassembling procedures Figs. ① → ⑥2	Lubricating : Types of oil		A3a / Moebius 9010
Reassembling procedures Figs. ⑥2 → ①	Oil quantity		A2a / Moebius 9030
			Normal quantity
			Sufficient quantity

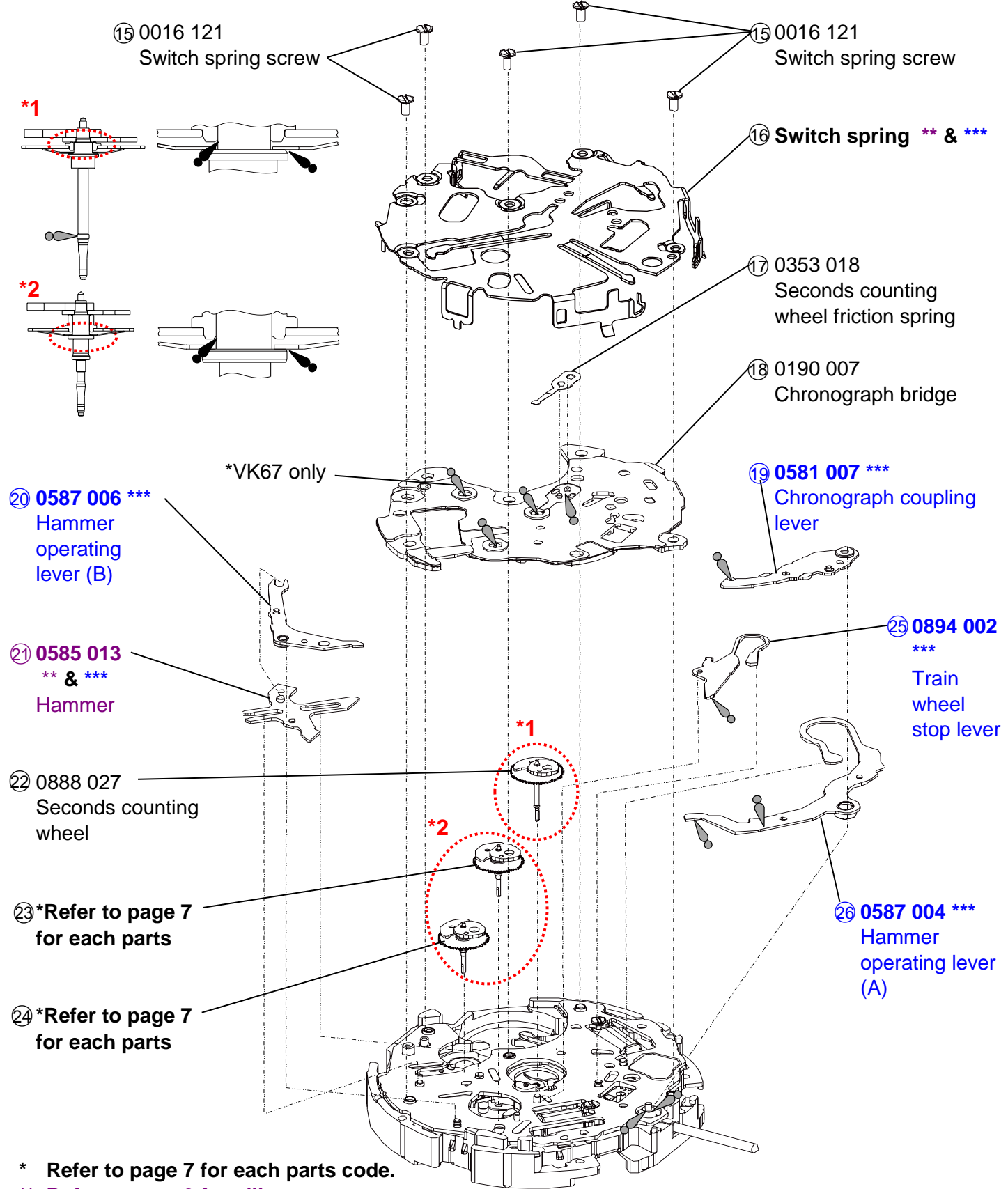

\* Refer to page 7 for each parts code.  
 \*\* Refer to page 9 for oiling spot.  
 \*\*\* Refer to page 10 for spring setting position.

Disassembling procedures Figs. ① → ⑥2	Lubricating : Types of oil		A3a / Moebius 9010
Reassembling procedures Figs. ⑥2 → ①	Oil quantity		A2a / Moebius 9030
			Normal quantity
			Sufficient quantity

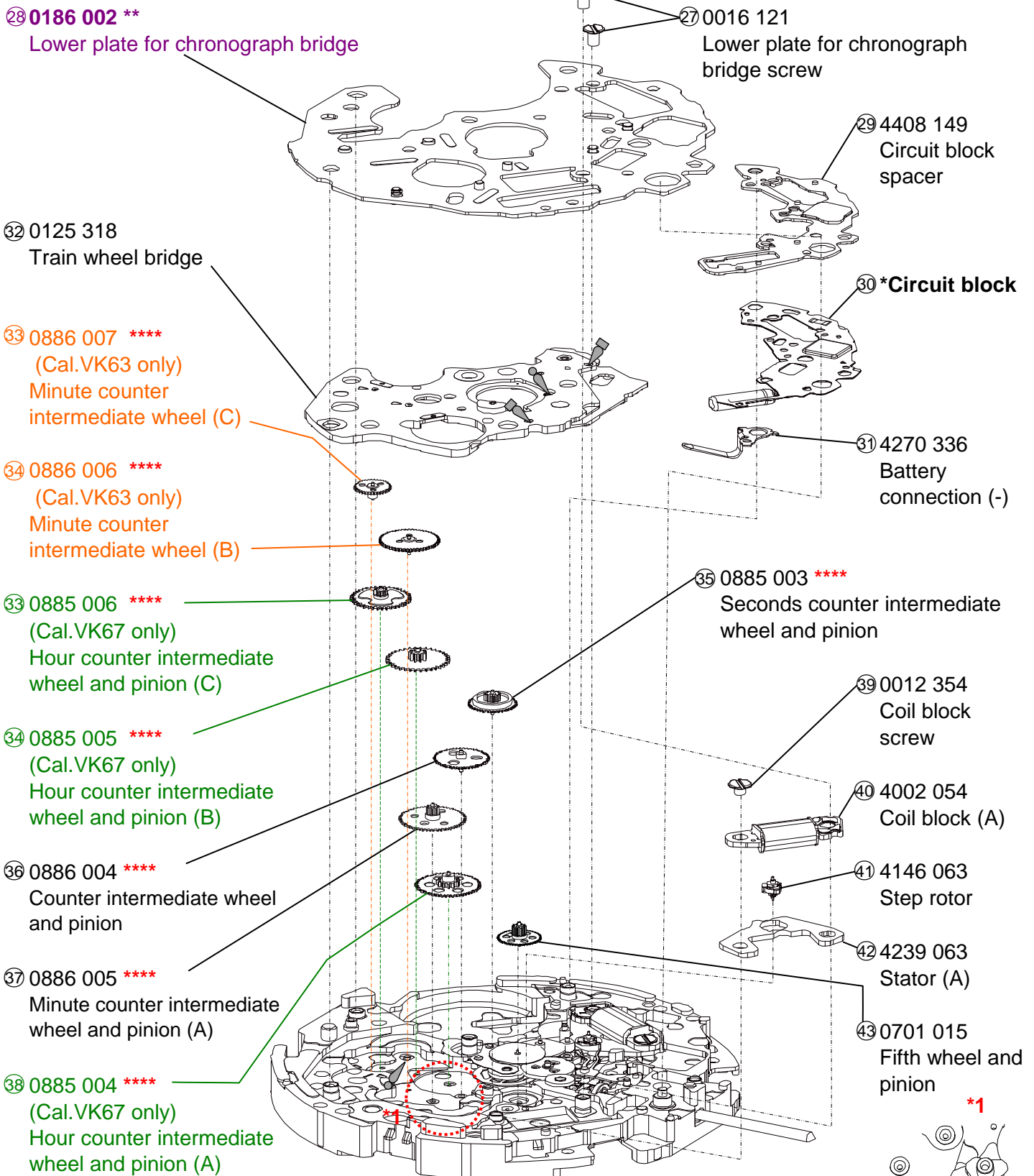





\* Refer to page 7 for each parts code.

\*\* Refer to page 9 for oiling spot.

\*\*\*\* Refer to page 8 for assembling of chronograph wheel.

\*VK67 only

\*1

Disassembling procedures Figs. ① → ⑥2	Lubricating : Types of oil
Reassembling procedures Figs. ⑥2 → ①	 A3a / Moebius 9010  A2a / Moebius 9030  Oil quantity  Sufficient quantity

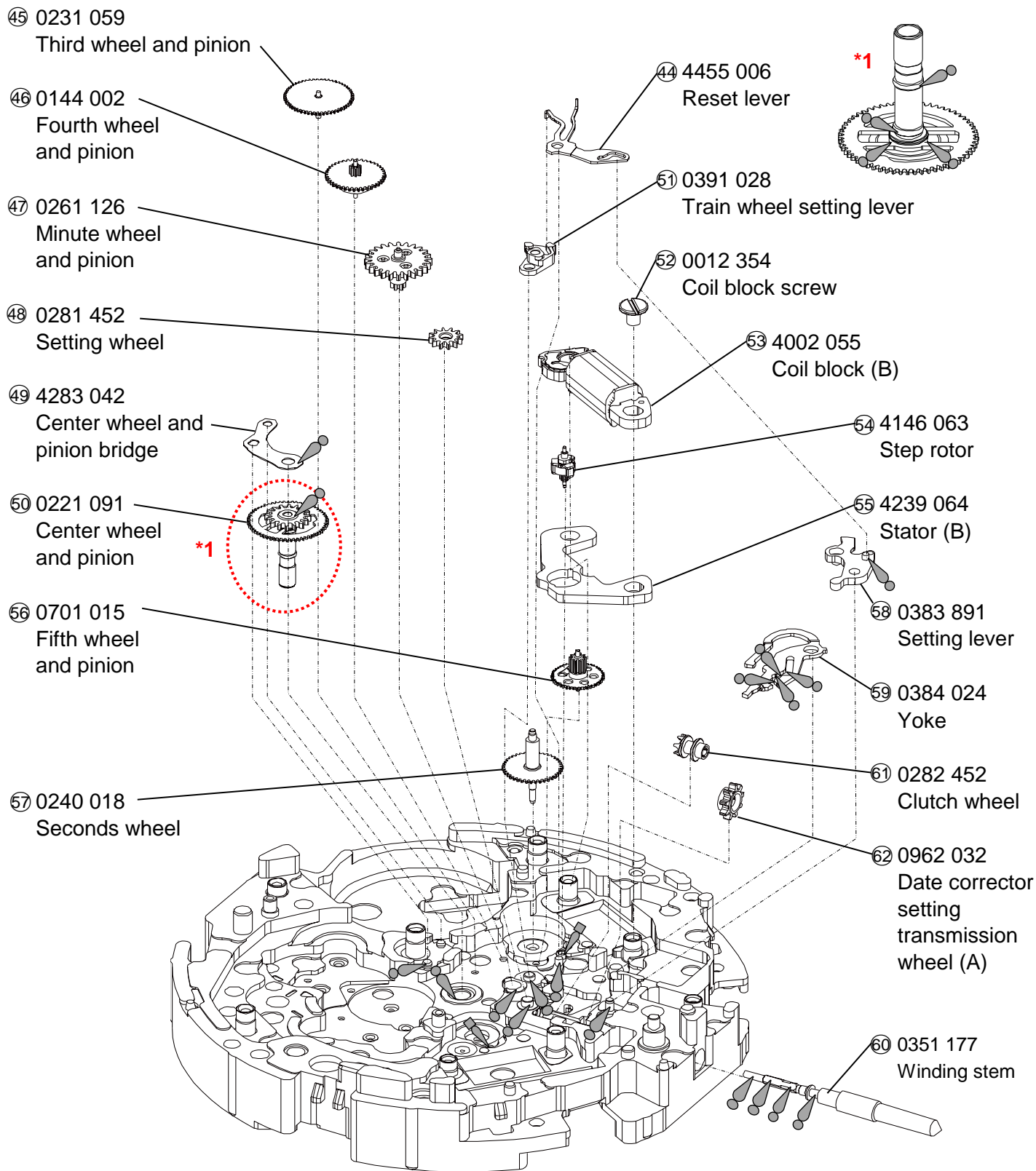

Remarks: **Different parts for each CAL.**

No	Cal.		Parts code	Parts name	Parts form
	VK63	VK67			
⑥	O	-	0817 048	Intermediate small hour hand wheel and pinion	
	-	O		Intermediate date wheel and pinion	
⑦	O	-	0157 012	Small hour hand wheel	
	-	O	0802 039	Date indicator driving wheel	
⑯	O	-	4250 076	Switch spring ( Differs by Cal. marking )	
	-	O	4250 072		
⑳	O	-	0685 003	Positioning arbor	
	-	O	<b>0902 017</b>	Minute counting wheel	
㉔	O	-	<b>0902 017</b>	Minute counting wheel	
	-	O		Hour counting wheel	
㉓	O	-	4004 353	Circuit block	
	-	O	4004 352		

**[ NOTE ]**

About the parts code "0902 017"

		New parts
No. ㉔	No. ㉓	No.㉓ & ㉔
-	-	0902 017

When you purchase this part,  
please order new one "0902 017."

③ Date indicator (Cal.VK63 / 67 common parts)

Parts code	Crown position	Date position	Color of figure	Color of background
0878 328	3H	3H (4.5H)	Black	White
0878 329	3H	3H (4.5H)	White	Black

**\* All parts code are subject to change without notice.**



## 1. Detailed assembling of chronograph wheel

[ NOTE ]

There is a mark on parts. Parts are set in order of the mark as shown in the table below.

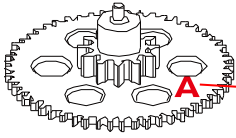
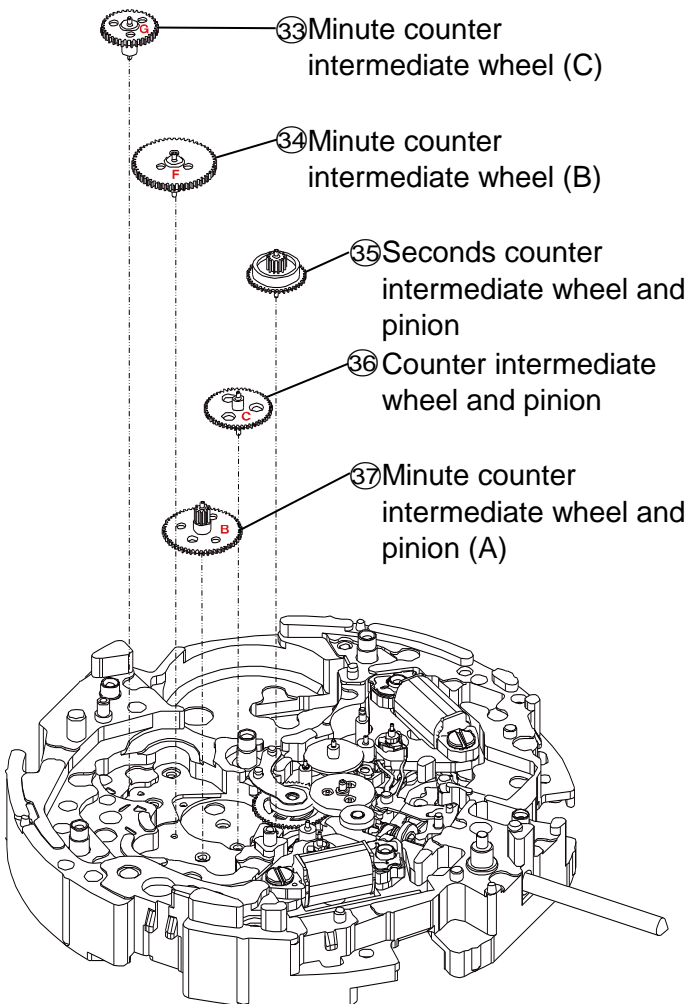

Image example of the mark

[ Cal.VK63 ]	
Mark	Parts name
<b>B</b>	③⑦ Minute counter intermediate wheel and pinion (A)
<b>C</b>	③⑥ Counter intermediate wheel and pinion
<b>Nil</b>	③⑤ Seconds counter intermediate wheel and pinion
<b>F</b>	③④ Minute counter intermediate wheel (B)
<b>G</b>	③③ Minute counter intermediate wheel (C)

[ Cal.VK67 ]	
Mark	Parts name
<b>A</b>	③⑧ Hour counter intermediate wheel and pinion (A)
<b>B</b>	③⑦ Minute counter intermediate wheel and pinion (A)
<b>C</b>	③⑥ Counter intermediate wheel and pinion
<b>Nil</b>	③⑤ Seconds counter intermediate wheel and pinion
<b>D</b>	③④ Hour counter intermediate wheel and pinion (B)
<b>E</b>	③③ Hour counter intermediate wheel and pinion (C)



### [ Cal.VK63 ]

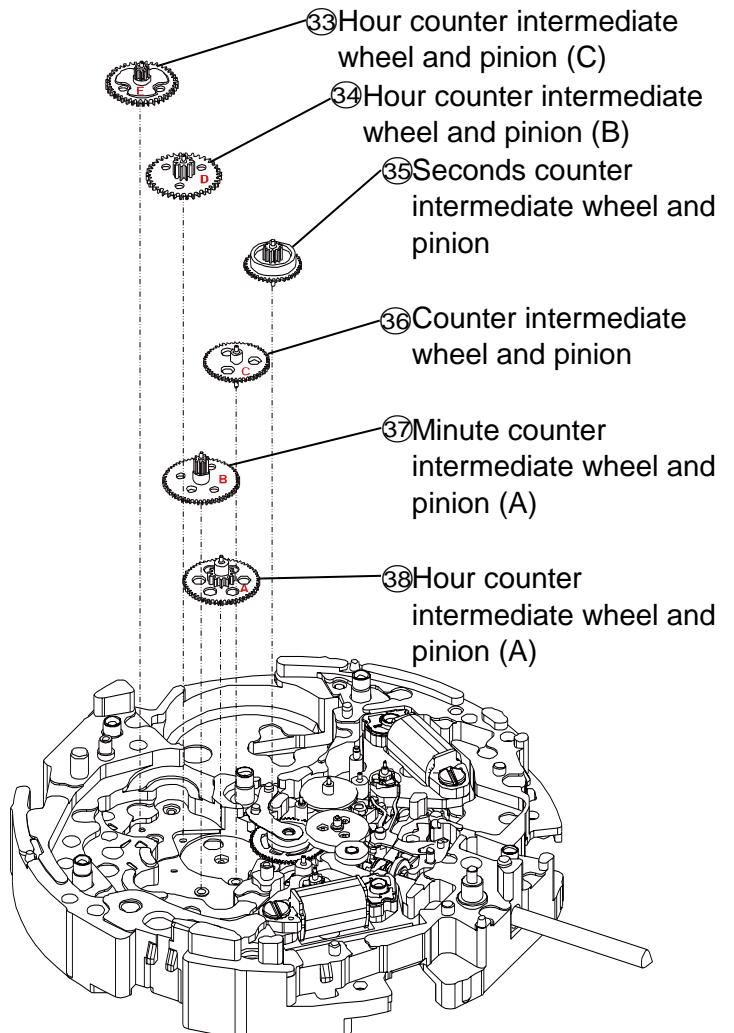

### [ Cal.VK67 ]

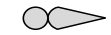
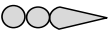

\*Mark positions, and sizes, etc. are different.

Lubricating : Types of oil	
	A3a / Moebius 9010
	A9a (S-6)
Oil quantity	
	Normal quantity
	Sufficient quantity

## 2.Oiling spot

⑳ Hammer

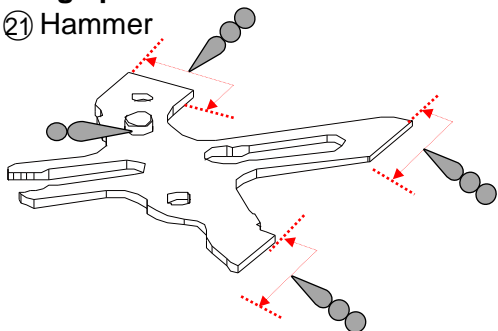

There must be oil within the range of the arrow.

㉘ Lower plate for chronograph bridge

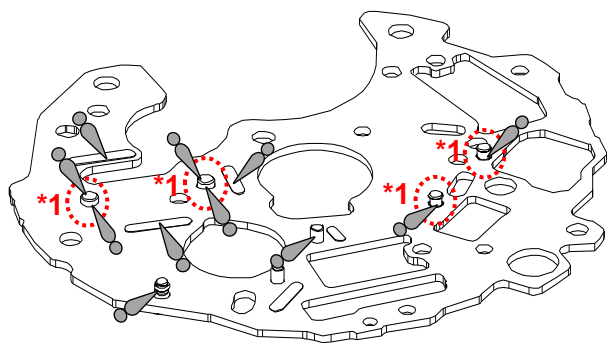

Note

**\*1:** Oiling should be done on the pointed spot of marked place.

⑯ Switch spring

\*Oiling spot and spring setting position.

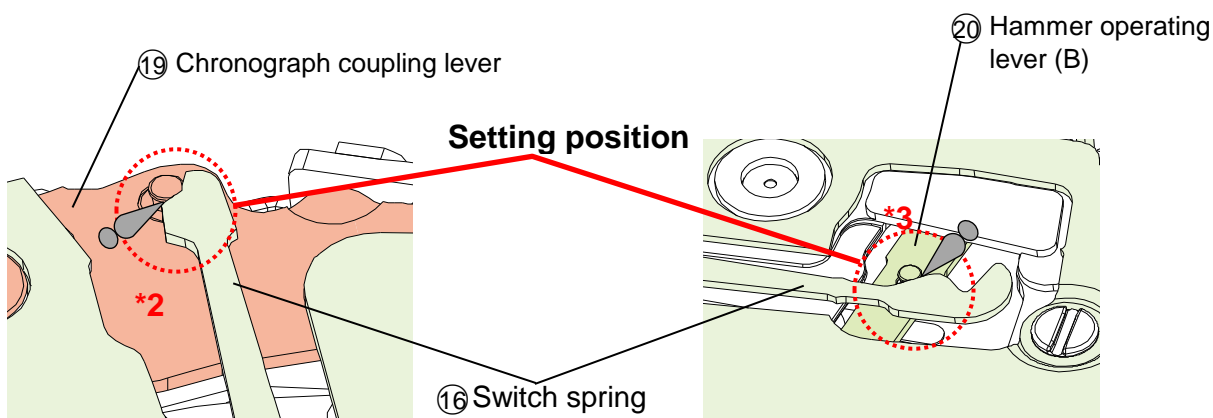
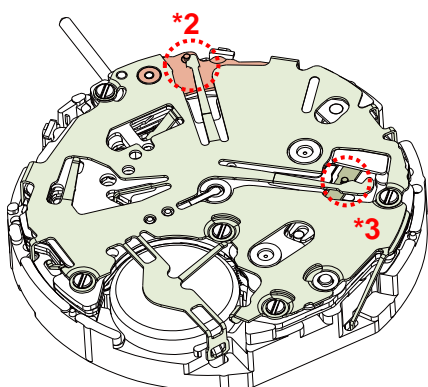

**\*Oiling should be done on the contact spot of the spring and the pin.**

### 3.Spring setting position

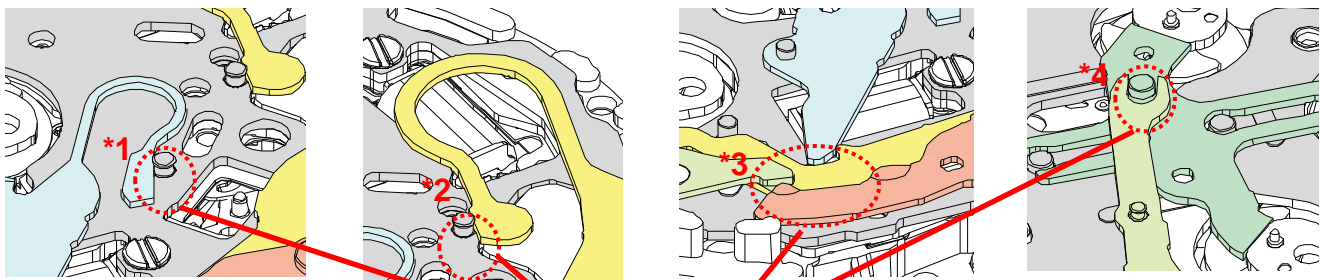
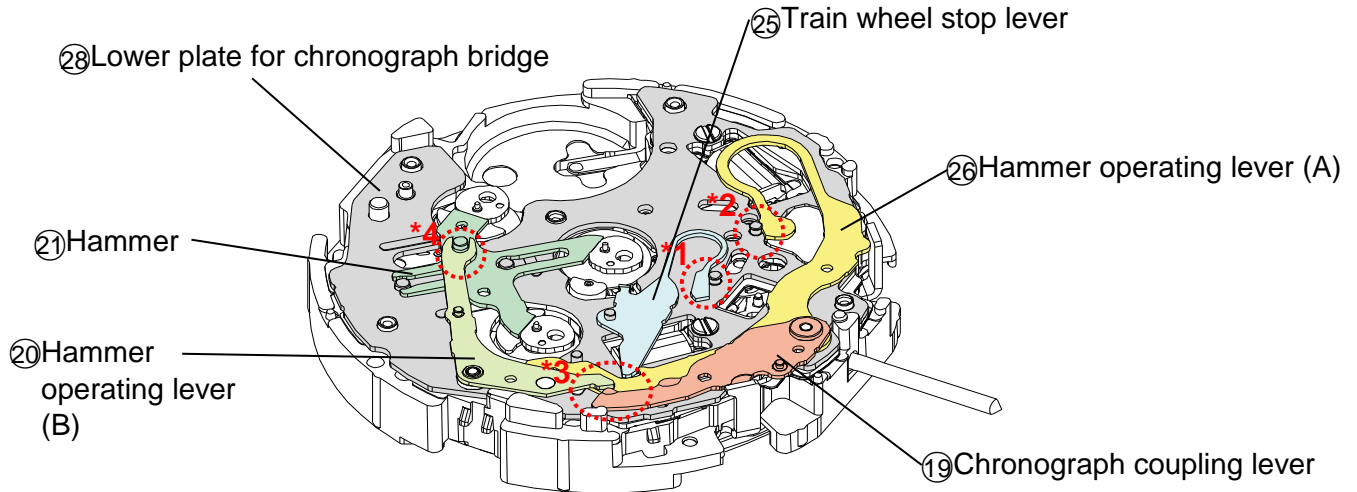

### Setting position

### 4.Switch lever (A) and (B) setting position

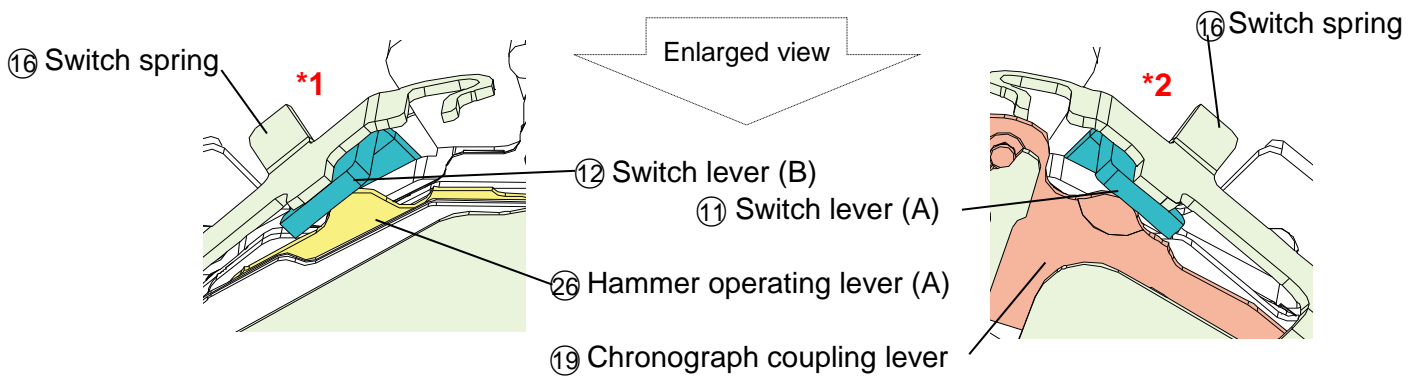
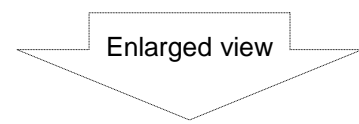
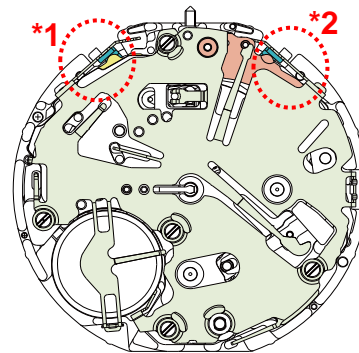

Switch lever (B) is set between the switch spring and hammer operating lever (A) .

Switch lever (A) is set between the switch spring and chronograph coupling lever.

## 5.To remove the winding stem

- 1) Set the winding stem to normal position.
- 2) Pull out the winding stem while pushing "A".

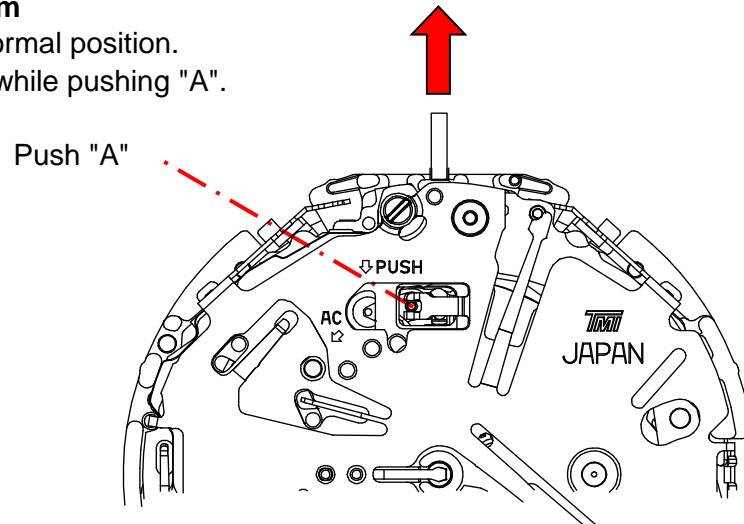

## 6.To remove or install the battery

- 1) Remove the hook of the switch spring's battery clamp.
- 2) Insert the battery sideways, and have the hook of the switch spring's battery clamp catch the main plate.

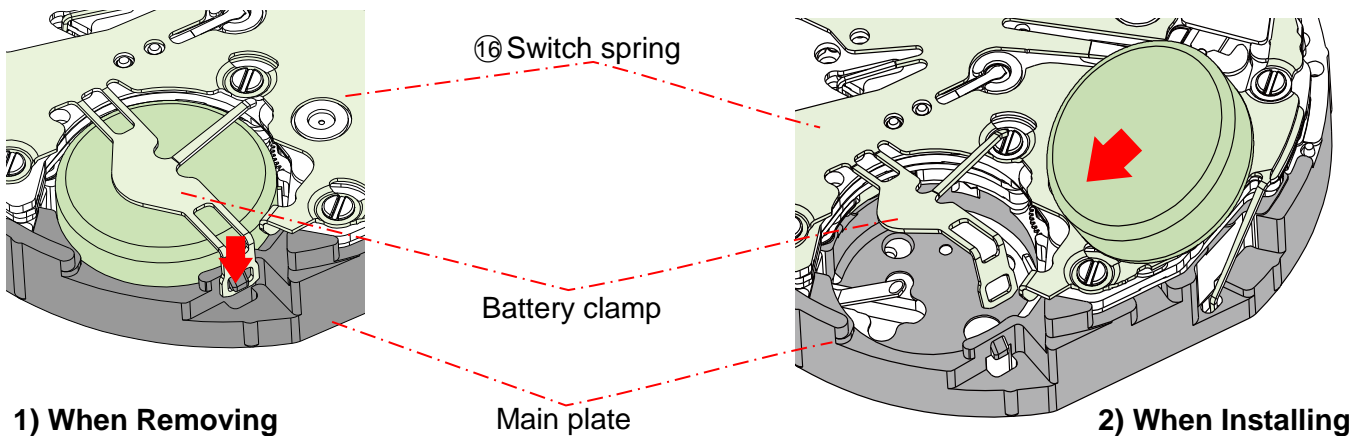

## 7.Remarks on installing the battery

- 1) After the battery is replaced with a new one, or after the battery is reinstalled following the repairing procedures, be sure to touch the AC terminal of circuit block and the switch spring with conductive tweezers to reset the circuit as illustrated.

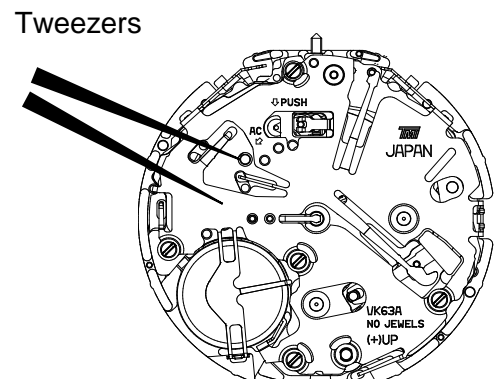

## 8.How to install the hands

Place the movement directly on a flat metal plate, or something alike to install the hands.

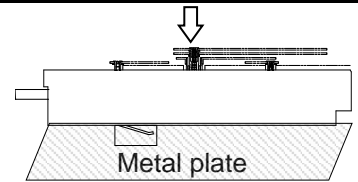

### [ Note: Second / Minute chronograph hands setting ]

- (1) Push button (A) ( Chronograph start )
- (2) Push button (A) ( Chronograph stop )
- (3) Push button (B) ( Chronograph reset )
- (4) After (1)-(3), Install the chronograph hands as shown in the table below.

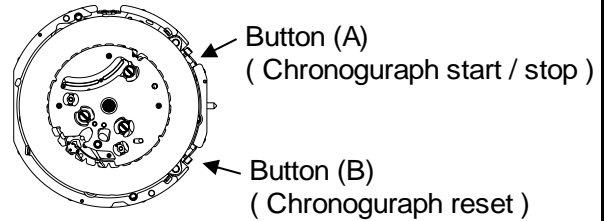

Cal.	VK63	VK67
Second chronograph	"12" o'clock (center)	"12" o'clock (center)
Minute chronograph	"60" minute ( 9H )	"60" minute ( 12H )
Hour chronograph	—	"12" hour ( 9H )

**\*Do not reuse the chronograph hands once detached. Please change and use new hands.**

### [ Note: To install 24 hour hand for VK63 ]

Before installing 24 hour hand, pull out the crown to the second click position and rotate it clockwise, until changed to the next date then install the 24 hour hand.

## 9.How to check correct hands attachment

**The hand's top surface should be set parallel with the axis tip, as shown below.**

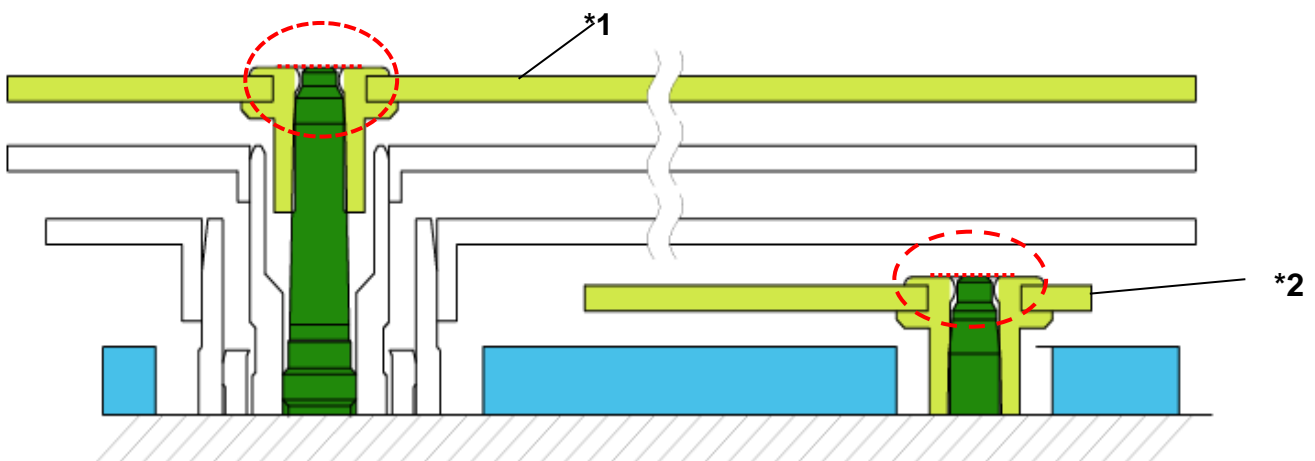

Application hands

\*1: Second chronograph hand

\*2: Minute / Hour chronograph hand and Small second hand and 24 hour hand

## DISPLAY AND CROWN / BUTTON OPERATION

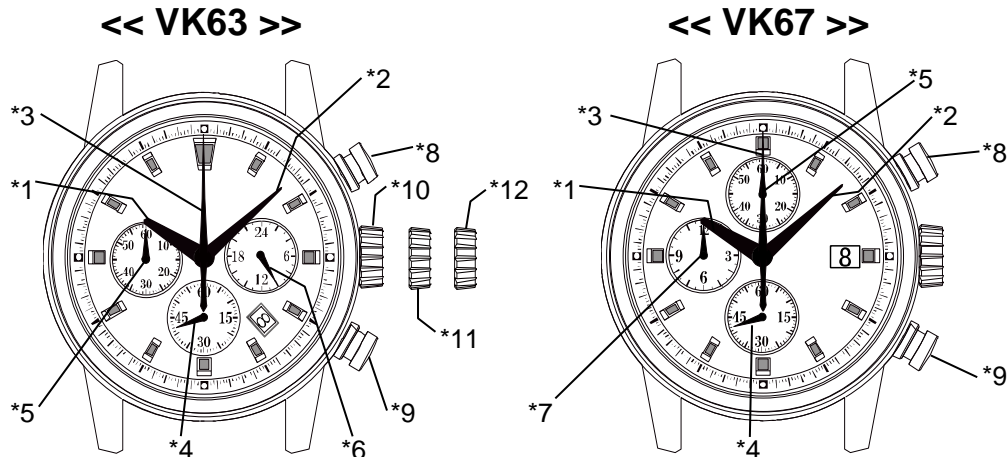

### Note

*1: Hour hand	*6: 24 hour hand	*11: Crown at first position (Date setting)
*2: Minute hand	*7: Chronograph hour hand (12 hour)	
*3: Chronograph second hand	*8: Button (A) (START / STOP)	*12: Crown at second position (Time setting)
*4: Small second hand	*9: Button (B) (RESET)	
*5: Chronograph minute hand (60 minute)	*10: Crown at normal position	

### 1.How to set the time

- 1) Pull out the crown to the second click position.
- 2) Turn the crown to set hour and minute hands.  
(Check that AM / PM is set correctly.)
- 3) Push the crown back into the normal position.

#### [ Note ]

If the crown is pulled to the second position while the chronograph is started, the chronograph hands will continue to move. This is not a malfunction.

### 2.How to set the date

- 1) Pull out the crown to the first click position.
- 2) Turn the crown clockwise for date setting.  
\*Do not set the date between 9:00 P.M. and 3:00 A.M. as this will cause a malfunction.
- 3) Push the crown back into the normal position.

### 3.How to reset (after battery change)

It is possible to reset by the following two methods.

- Method 1 {
- 1) Set the crown to the normal position.
  - 2) Touch the AC terminal of circuit block and the switch spring with conductive tweezers to reset the circuit.
  - 3) The small second hand will move at two-second interval for 10 seconds.
- Method 2 {
- 1) Pull out the crown to the second click position.
  - 2) Press the button (B) for two seconds and release the button.
  - 3) Push the crown back to the normal position.
  - 4) The small second hand will move at two-second interval for 10 seconds.

\* If the crown is operated within this 10 seconds, the two-second interval movement will not activate.

**[ Note ]**

It is not necessary to set the chronograph hands after the battery is exchanged.  
If the chronograph hands position are incorrect, following below procedure all the chronograph hands will be reset to "0" position.



## HOW TO USE THE CHRONOGRAPH

**[ Standard measurement ]**

Press the buttons in the following order : A → A → B



( 6 hour 20 minutes 10 seconds )

- Press button (A) to start the chronograph.  
The chronograph second hand will start moving.

- Press button (A) again to stop the chronograph.  
The chronograph hands stop to indicate the elapsed time.

- Press button (B) to reset the chronograph.  
All the chronograph hands will be reset to "0" position.

**Note**

**[ Cal.VK63 ]**

The chronograph can measure up to 60 minutes.  
The chronograph stops after a measurement for 60 minutes.

**[ Cal.VK67 ]**

The chronograph can measure up to 12 hours.  
The chronograph stops after a measurement for 12 hours.

\* Restart by pushing button (A).

**[ Cal.VK63 / 67 in common ]**

\* During the chronograph operation, button (B) (reset) can be pushed. There is no problem with the function.

**[ Accumulated elapsed time measurement ]**

Press the buttons in the following order : A → A / A ... → A → B

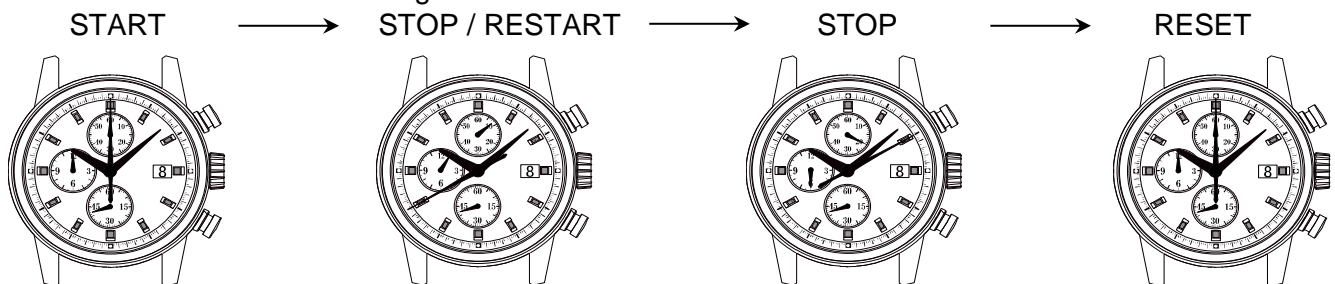

( 1 hour 8 minutes 40 seconds ) ( 6 hour 20 minutes 10 seconds )

\* Restart and stop of the chronograph can be repeated as many times as necessary by pressing button (A)