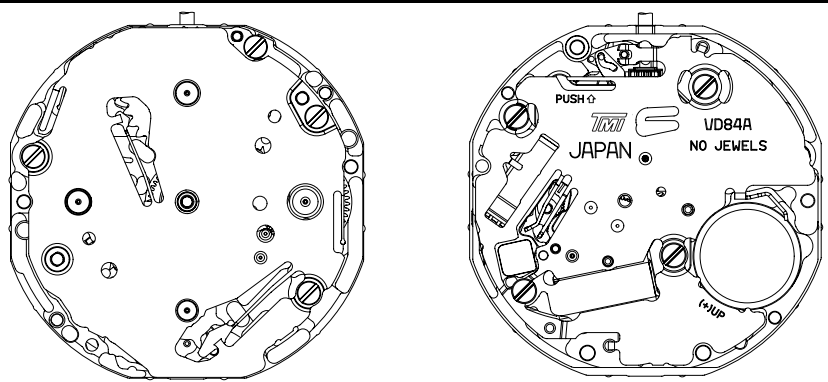

**TECHNICAL GUIDE  
&  
PARTS CATALOGUE**

**Cal.VD8 Series  
(Cal.VD84A/85A/86A/87A)**

**ANALOGUE QUARTZ**

	Cal. No.	VD84A			
Item					
Movement		<p><b>*Refer to page 2 for other Cal. No. specifications.</b></p>			
Movement size	Outside diameter	φ23.70 mm 22.60 mm : between 12 o'clock and 6 o'clock sides 22.60 mm : between 3 o'clock and 9 o'clock sides			
	Casing diameter	φ23.30 mm 22.10 mm : between 12 o'clock and 6 o'clock sides 21.40 mm : between 3 o'clock and 9 o'clock sides			
	Total height	3.45 mm			
Time indication	Cal. No.	VD84A	VD85A	VD86A	VD87A
	Hands	6	5	5	5
	2 Hands (hour, minute)	○	○	○	○
	Small Second hand (6 H)	○	○	○	○
	24 Hour hand (12 H)	○	×	×	×
	Date Calendar hand (3 H)	○	○	×	×
	Date Calendar hand (2 H)	×	×	○	○
	Day Calendar hand (9 H) Retrograde	○	○	×	○
Day Calendar hand (10 H) Retrograde	×	×	○	×	
Driving system	Step motor				
Additional mechanism	Electronic circuit reset switch Second setting device Date setting				
Antimagnetic	≥ 1600 A/m				
Accuracy	Less than ± 20 seconds : Monthly rate at normal temperature range				
Battery	SR626SW (Silver oxide battery) Battery life is approximately 3 years				
Measuring gate by quartz tester	Use 10 second gate * Set the winding stem with crown at the normal position				
Jewels	0 Jewel				

### VD84A

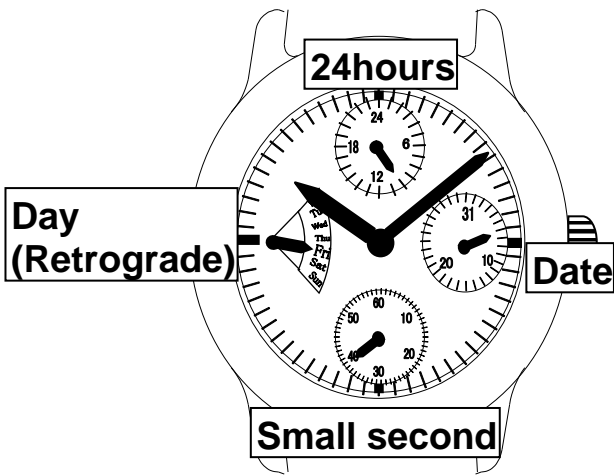

### VD85A

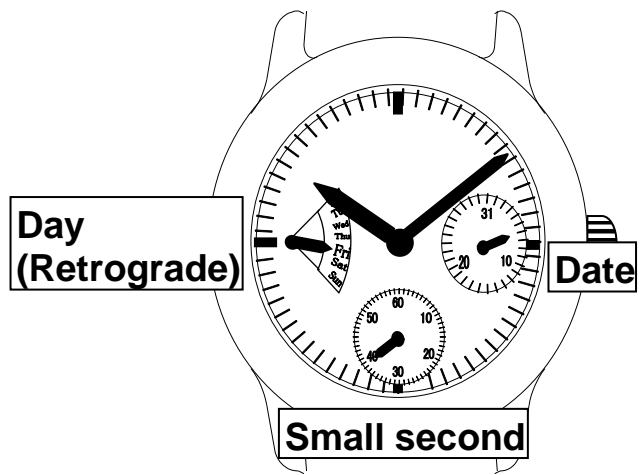

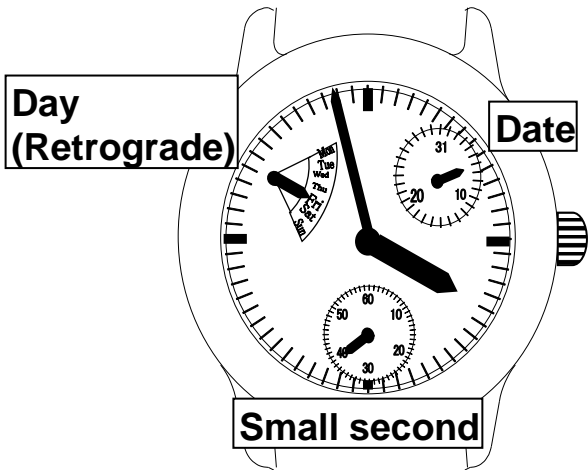

### VD86A



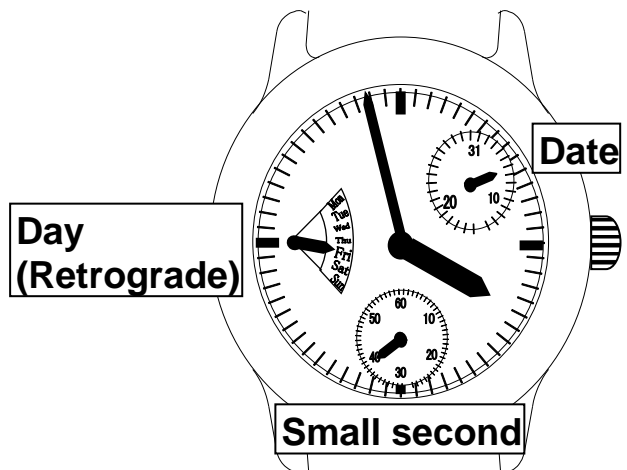



### VD87A

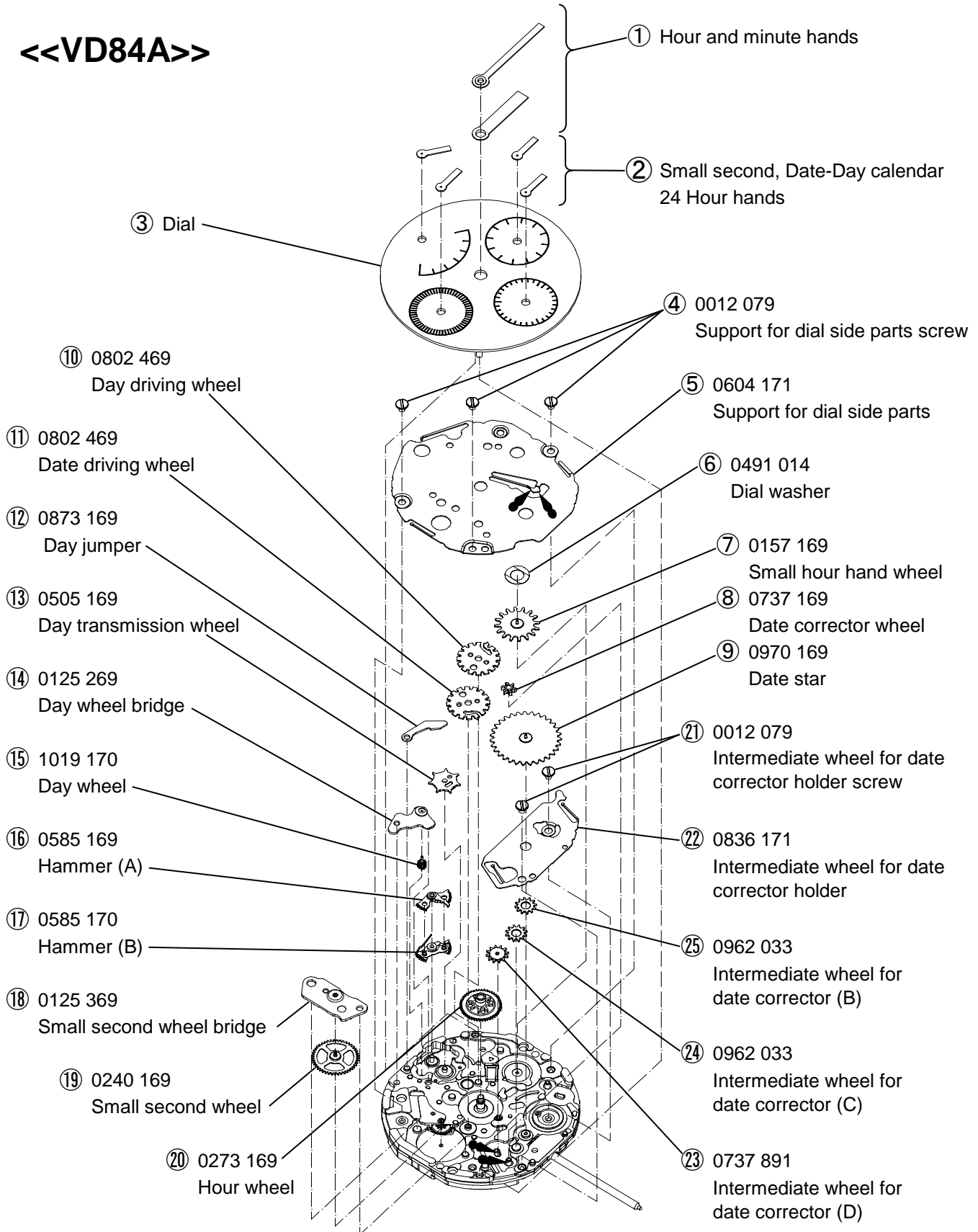

Disassembling procedures Figs. ① → ④⑦	Lubricating : Types of oil  A3a / Moebius 9010  A2a / Moebius 9030
Reassembling procedures Figs. ④⑦ → ①	
	Oil quantity  Normal quantity



## <<VD84A>>



Disassembling procedures Figs. ① → ④⑦	Lubricating : Types of oil  A3a / Moebius 9010  A2a / Moebius 9030
Reassembling procedures Figs. ④⑦ → ①	
	Oil quantity  Normal quantity

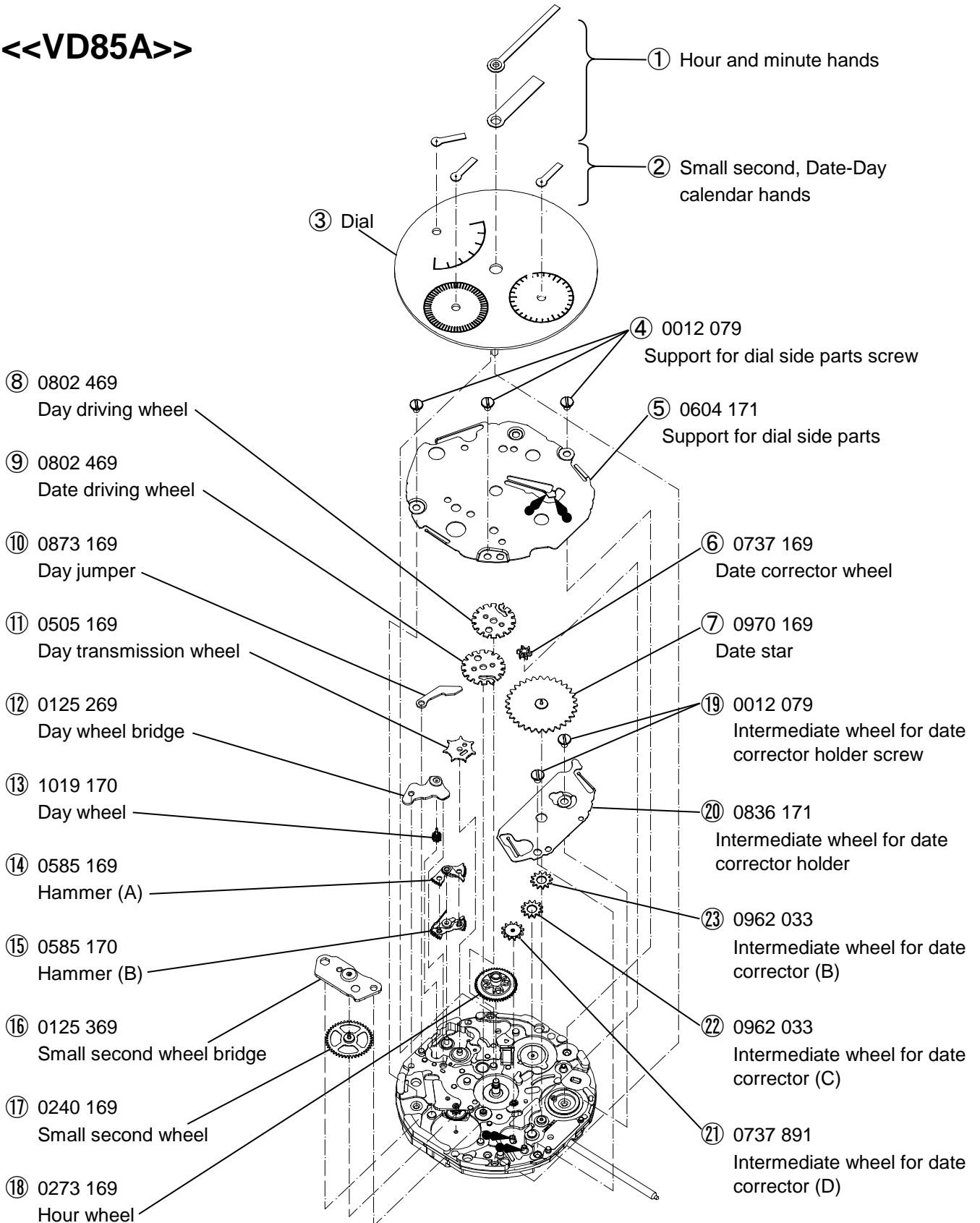

## <<VD85A>>



Disassembling procedures Figs. ① → ④⑦	Lubricating : Types of oil  A3a / Moebius 9010  A2a / Moebius 9030
Reassembling procedures Figs. ④⑦ → ①	
	Oil quantity  Normal quantity

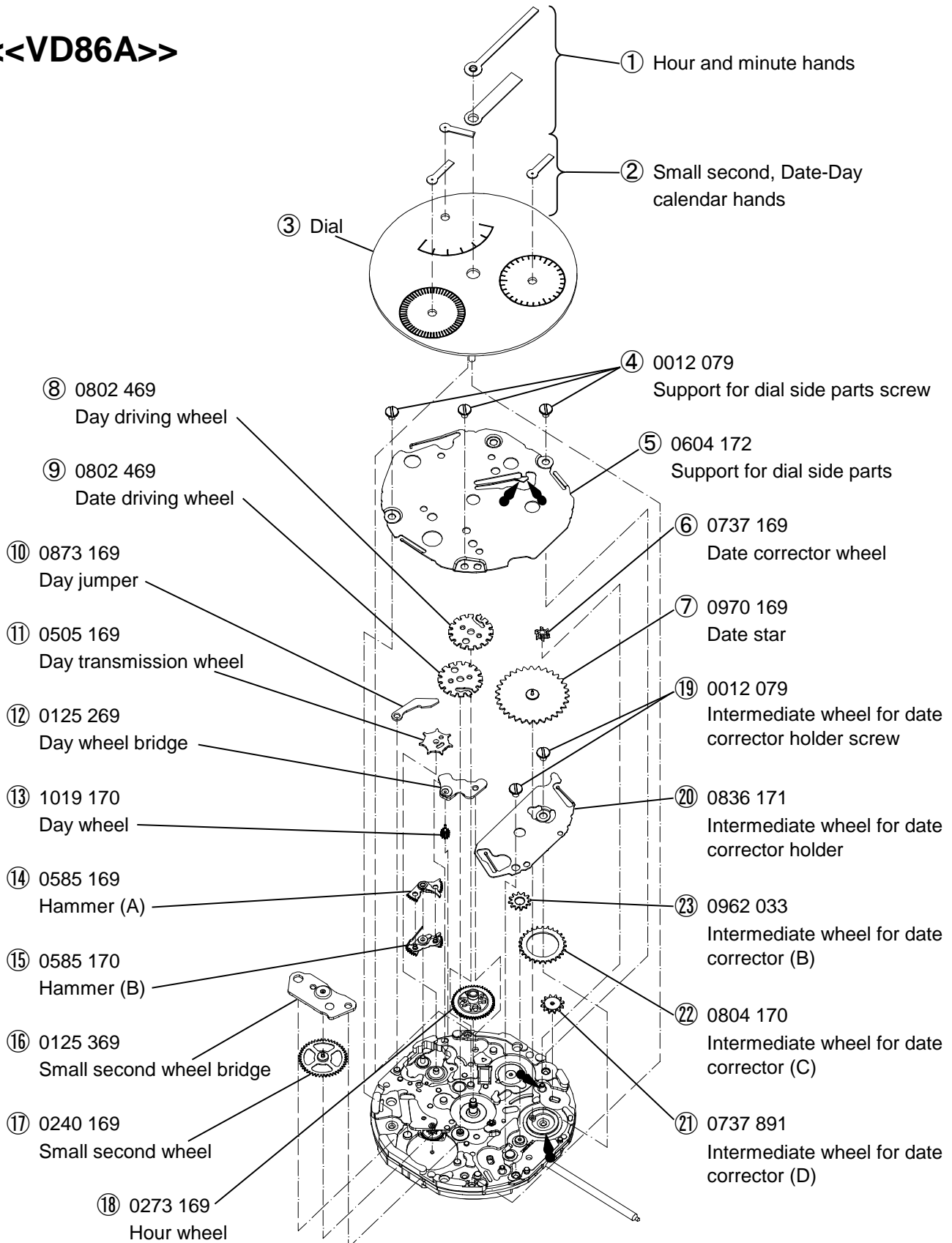

## <<VD86A>>

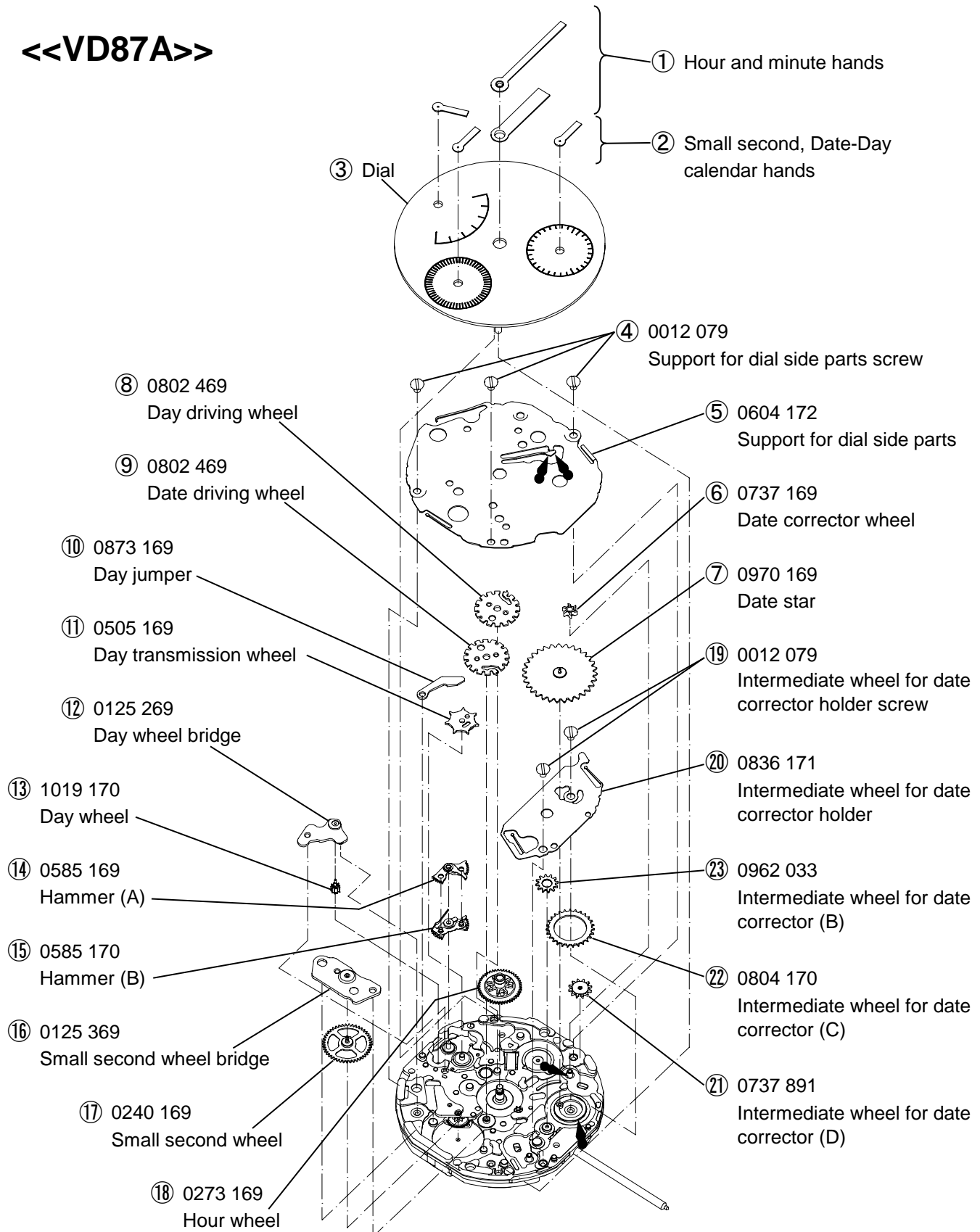

Disassembling procedures Figs. ① → ④⑦	Lubricating : Types of oil  A3a / Moebius 9010  A2a / Moebius 9030
Reassembling procedures Figs. ④⑦ → ①	
	Oil quantity  Normal quantity

## <<VD87A>>



Disassembling procedures Figs. ① → ④⑦	Lubricating : Types of oil
Reassembling procedures Figs. ④⑦ → ①	 A3a / Moebius 9010  A2a / Moebius 9030
	Oil quantity  Normal quantity

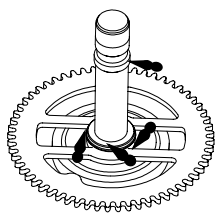
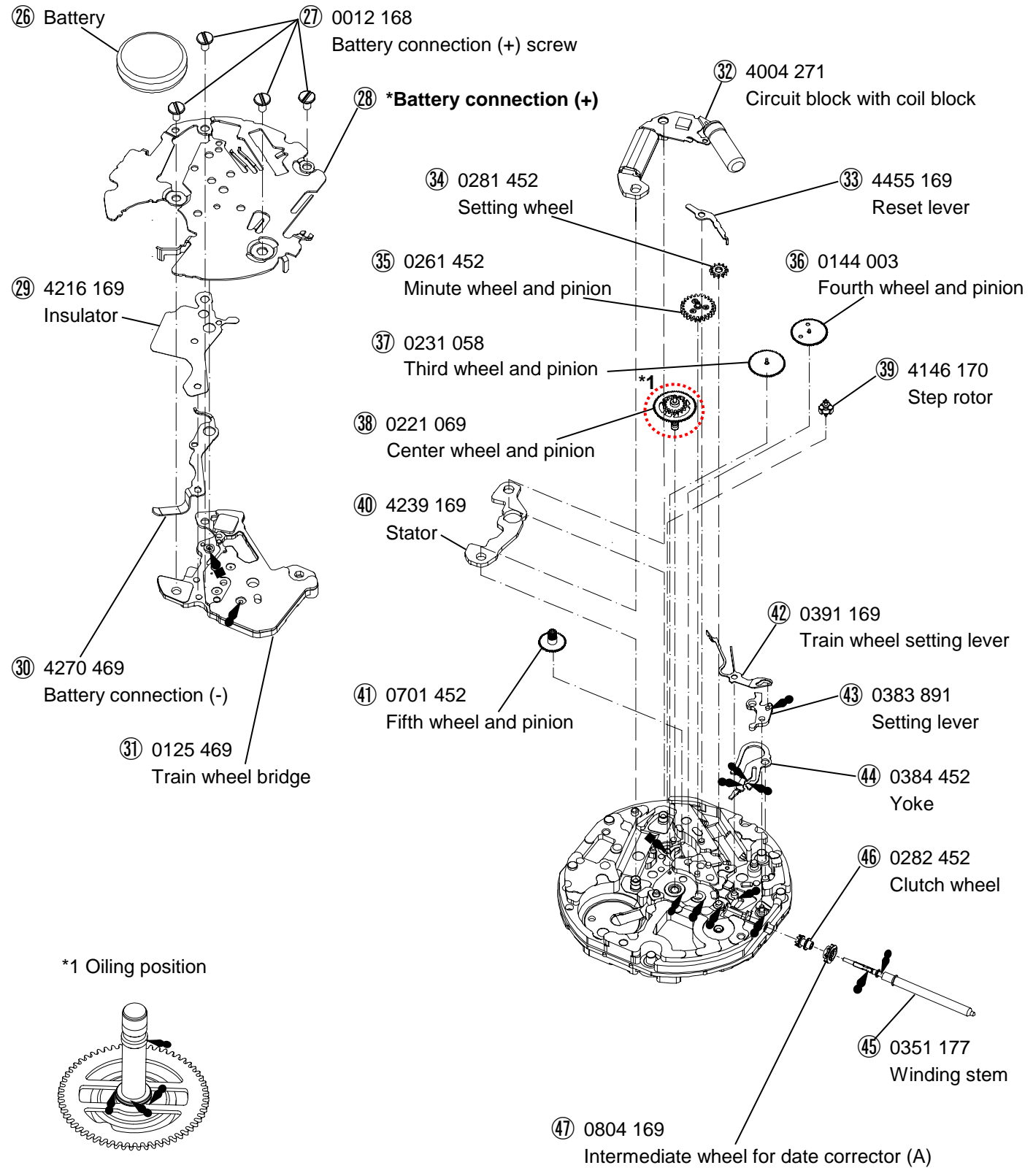

\*Refer to page 9 for each parts code



Remarks:

O Different parts for each CAL.

Parts name	Parts code	VD84A	VD85A	VD86A	VD87A
Battery connection (+)	4271 476	O	—	—	—
	4271 477	—	O	—	—
	4271 478	—	—	O	—
	4271 494	—	—	—	O

**\* All parts code are subject to change without notice.**

•The explanation here is only for the particular point of Cal.VD84A/VD85A/VD86A/VD87A

## REMARKS ON DISASSEMBLING AND REASSEMBLING

### (1)HAND

•How to install hands

Place the movement directly on a flat metal plate or the like to install the hands.

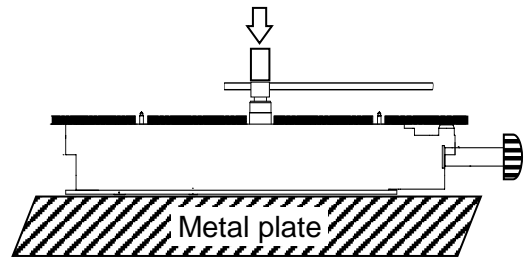

Note: How to procedure hands

- ①The state of movement is confirmed by the position of a right picture.  
Pull out the crown to the second click position and rotation. The position is setting.
- ②Dial setting.
- ③Install the Day calendar hand at the first position.
- ④Install the Date calendar and small second hands at the 12 o'clock position.
- ⑤Pull out the crown to the second click position and rotation it clockwise the change date.
- ⑥Install the 24 hour and hour and minute hands at the 12 o'clock position.

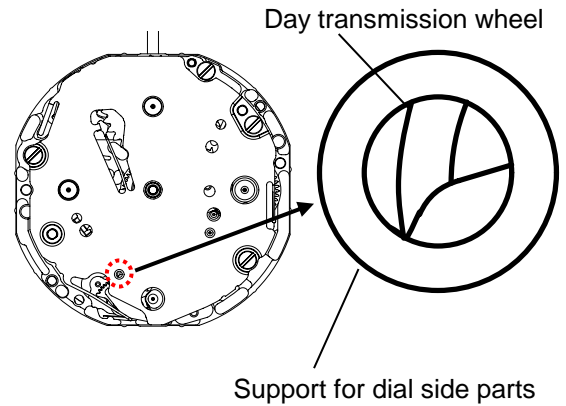

### (2)Day calendar (Retrograde) hand

•Be quick in Day calendar hand

The hand instantaneously returns from B position to A position when one week passes.

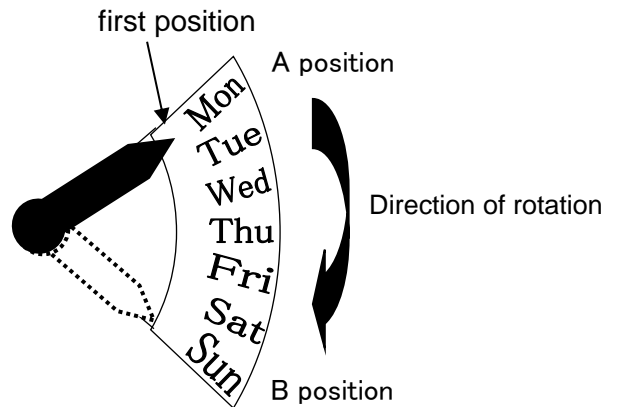

### (3)Winding stem

•How to remove

While pushing the indented portion of the arrow pull out the winding stem.

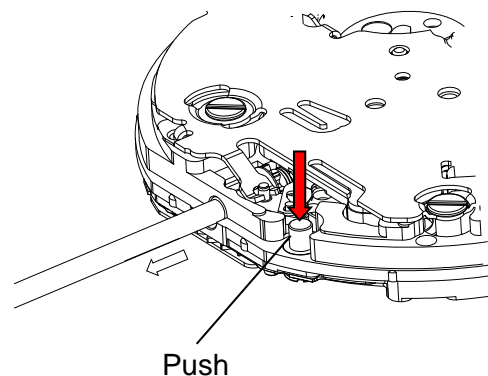

## (4) Battery

### •How to install

Insert the battery aslant in the direction shown by the arrow.  
Check the battery connection (+) securely touches the side face of the battery.

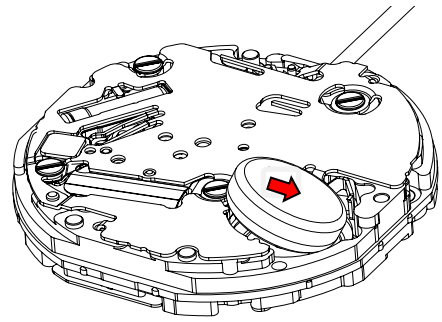

## (5) Insulator

Notes: To insulate between the battery connection (+) and the battery connection (-), the insulator should put at the three pin securely as bellow.

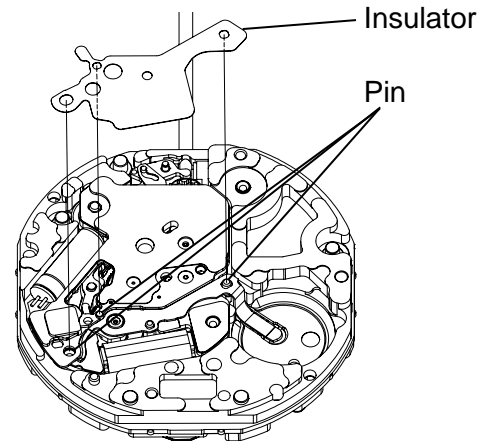

## (6) Day jumper and support for dial side parts

### •Reassembling procedures

The support for dial side parts spring set to the day jumper. (A position)

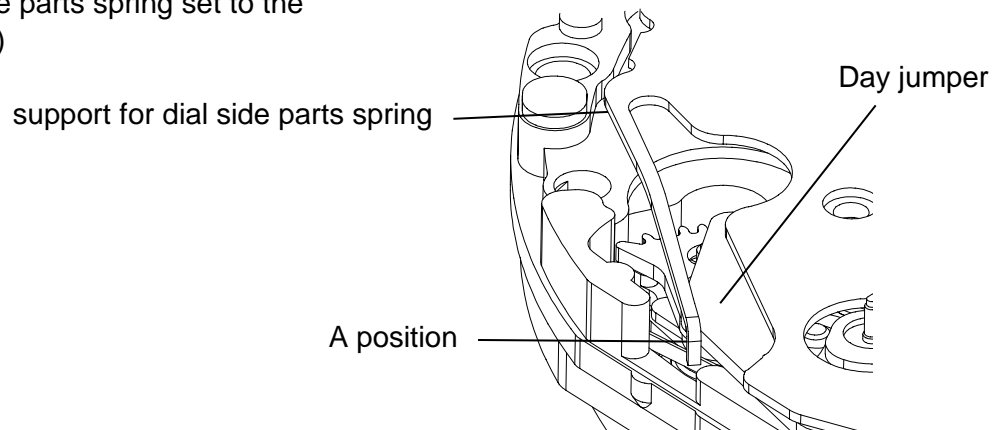

(7) Setting position (Notes at the time of disassembling and a reassembling)

•How to Date-Day driving wheels setting position

Note:

- The Date indicator finger of a Date driving wheels is setting position "O"mark of Main plate.
- The Day indicator finger of a Day driving wheels is setting position "Δ"mark of Main plate.

« Cal. VD84A · VD85A setting position »

« Cal. VD86A · VD87A setting position »

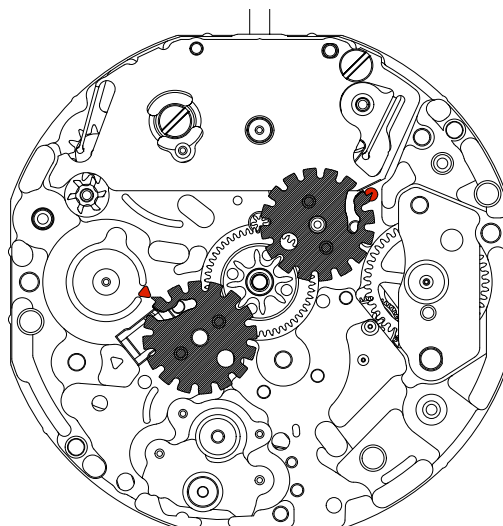
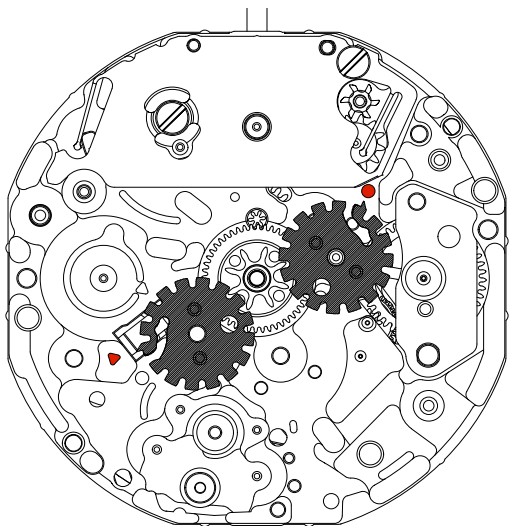

Enlargement

Enlargement

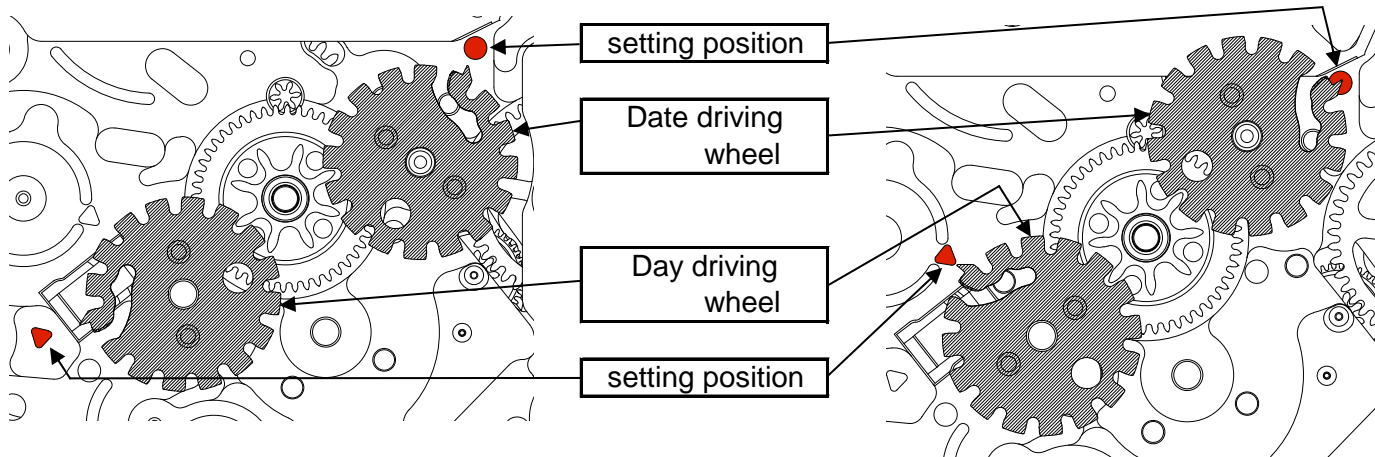

## DISPLAY AND CROWN OPERATION

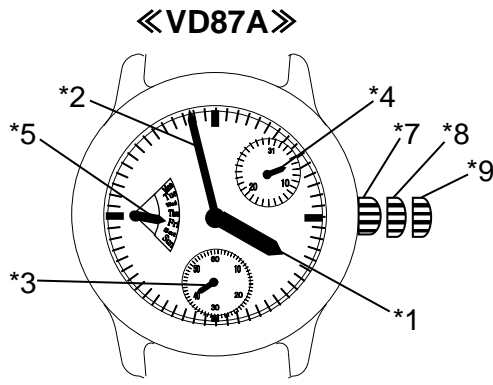
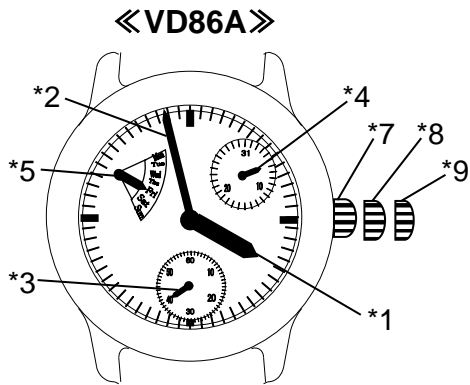
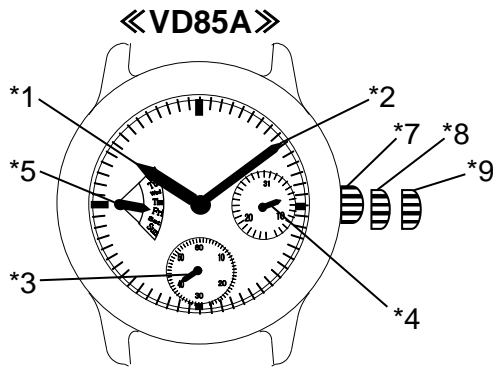
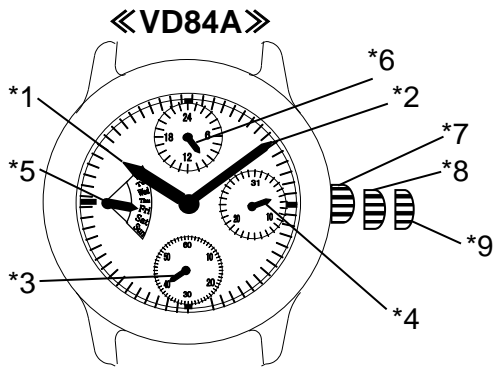

Note:

- \*1: Hour hand
- \*2: Minute hand
- \*3: Small second hand
- \*4: Date calendar hand
- \*5: Day calendar hand (Retrograde)
- \*6: 24 Hour hand
- \*7: Crown at normal position
- \*8: First click
  - Date setting (Quick change function)
- \*9: Second click
  - Time setting

## TIME SETTING

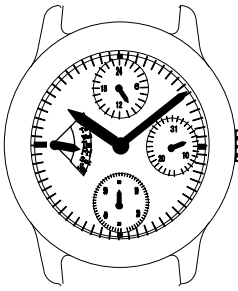

1.Pull out the crown to the second click when the small second hand is at the 12 O'clock position.

Turn the crown rotation to set the day of the week.

Turn the crown to set the hour and minute hands to the time.  
(check that AM/PM is set correctly)

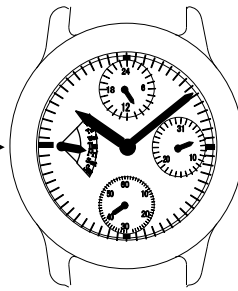

2.Push the crown back in to the normal position in signal.  
Pull out the crown to the first click.

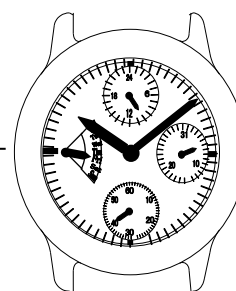

3.Pull out the crown to the first click.  
turn the crown counter-clockwise to set the date.  
(Quick change function)

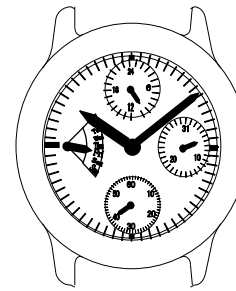

4.Push the crown back in to the normal position.

\*Do not set the date between 10:00 PM and 2:00 AM

Otherwise, the day may not change properly. If it is necessary to set the date during that time period, First change the time to any time outside it, set the date and then reset the correct time.