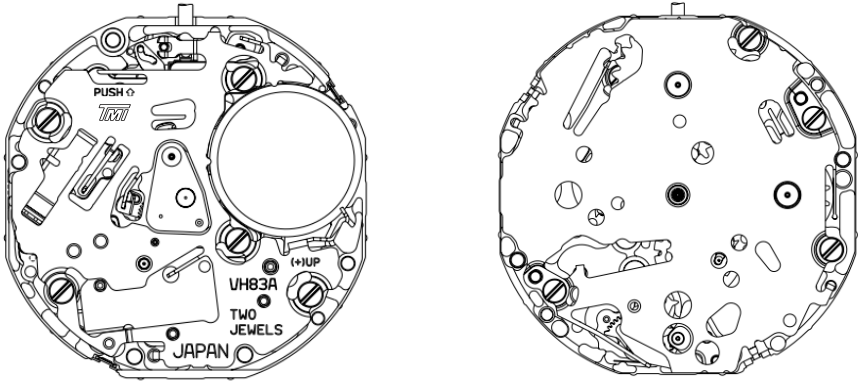

**TECHNICAL GUIDE
&
PARTS CATALOGUE**

**Cal.VH8 Series
(VH83A/88A)**

ANALOGUE QUARTZ

	Cal. No.	VH83A	
Movement			
*Refer to the pages 2 for other Cal. No. specifications.			
Movement size	Outside diameter	ϕ 23.70 mm 22.60 mm : between 12 o'clock and 6 o'clock sides 22.60 mm : between 3 o'clock and 9 o'clock sides	
	Casing diameter	ϕ 23.30 mm 22.10 mm : between 12 o'clock and 6 o'clock sides 21.40 mm : between 3 o'clock and 9 o'clock sides	
	Total height	3.45 mm	
Time indication	Cal. No.	VH83A	VH88A
	3 Hands (Hour, Minute, Second)	○	○
	24 Hour hand (6H)	○	○
	Date Calendar hand (3H)	○	—
	Date Calendar hand (2H)	—	○
	Date Calendar hand (12H)	—	—
	Day Calendar hand (9H)	○	—
Day Calendar hand (10H)	—	○	
Driving system	Step motor		
Additional mechanism	Electronic circuit reset switch Second setting device Date setting Day : Retrograde		
Antimagnetic	\geq 1600 A/m		
Accuracy	Less than \pm 15 seconds : Monthly rate at normal temperature range		
Battery	SR920SW (Silver oxide battery) Battery life is approximately 2 years		
Measuring gate by quartz tester	Use 10 second gate *Set the winding stem with crown at the normal position		
Jewels	2 Jewels		

VH83A

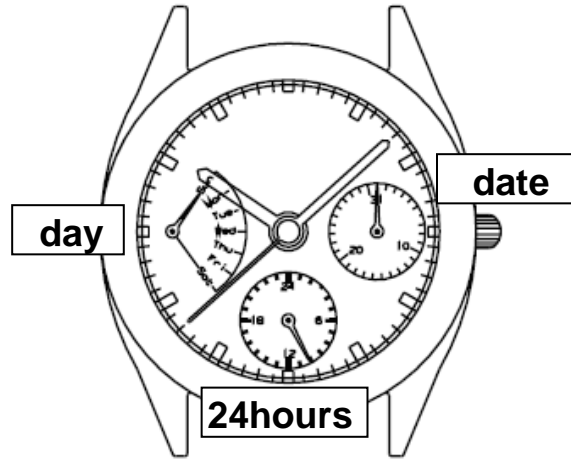

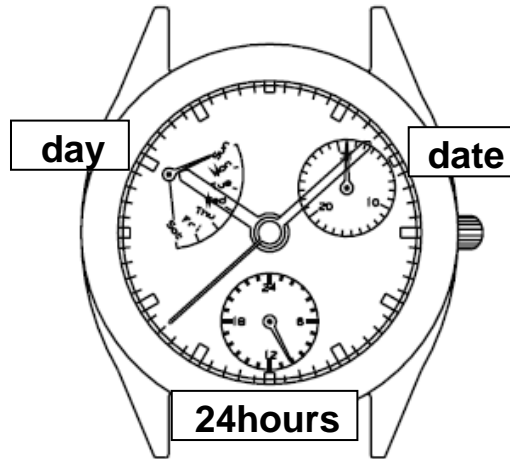

VH88A

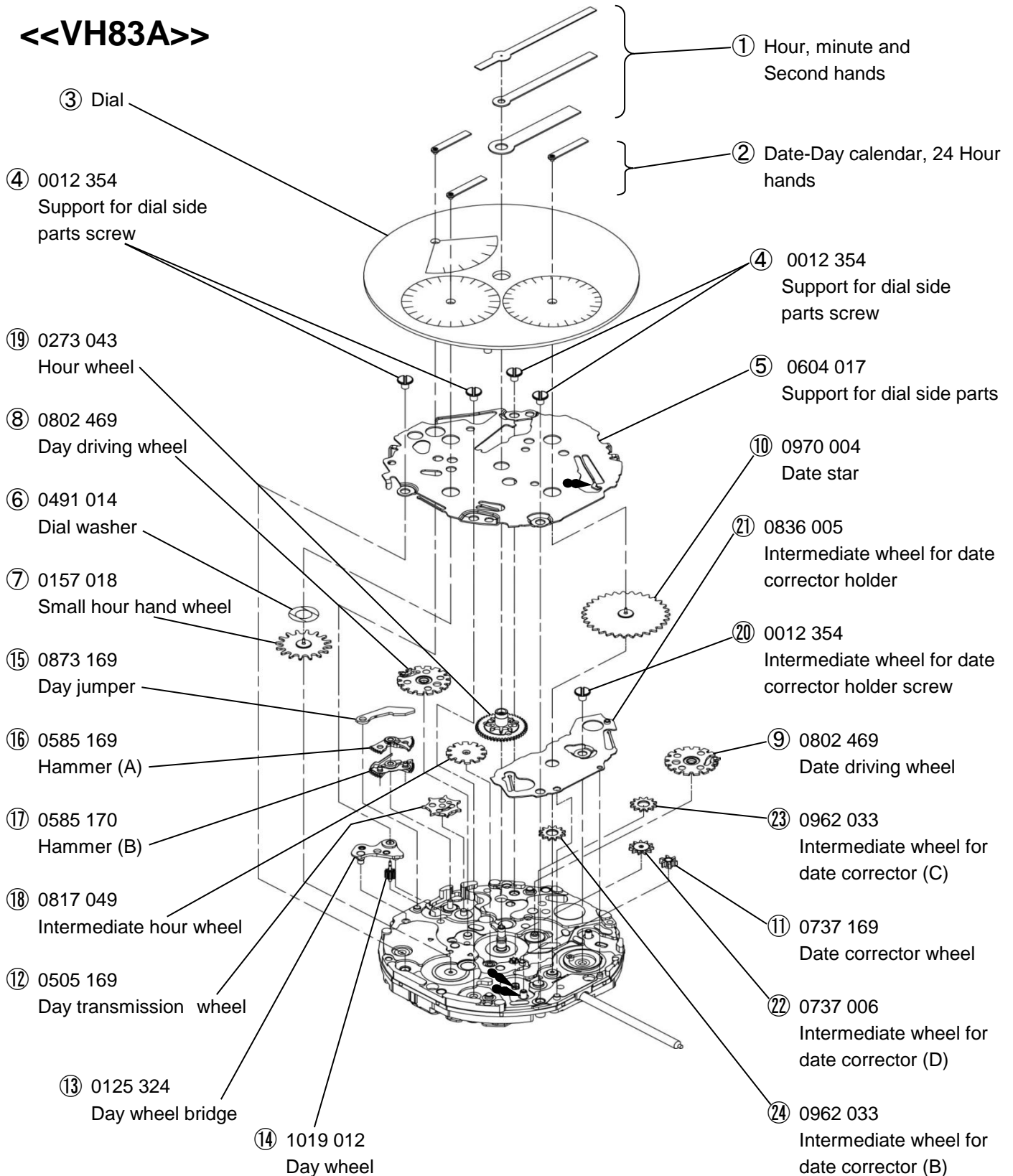

Disassembling procedures Figs. ① → ⑤①	Lubricating : Types of oil A3a / Moebius 9010 A2a / Moebius 9030
Reassembling procedures Figs. ⑤① → ①	

<<VH83A>>



Disassembling procedures Figs. ① → ⑤①	Lubricating : Types of oil  A3a / Moebius 9010  A2a / Moebius 9030
Reassembling procedures Figs. ⑤① → ①	

<<VH88A>>

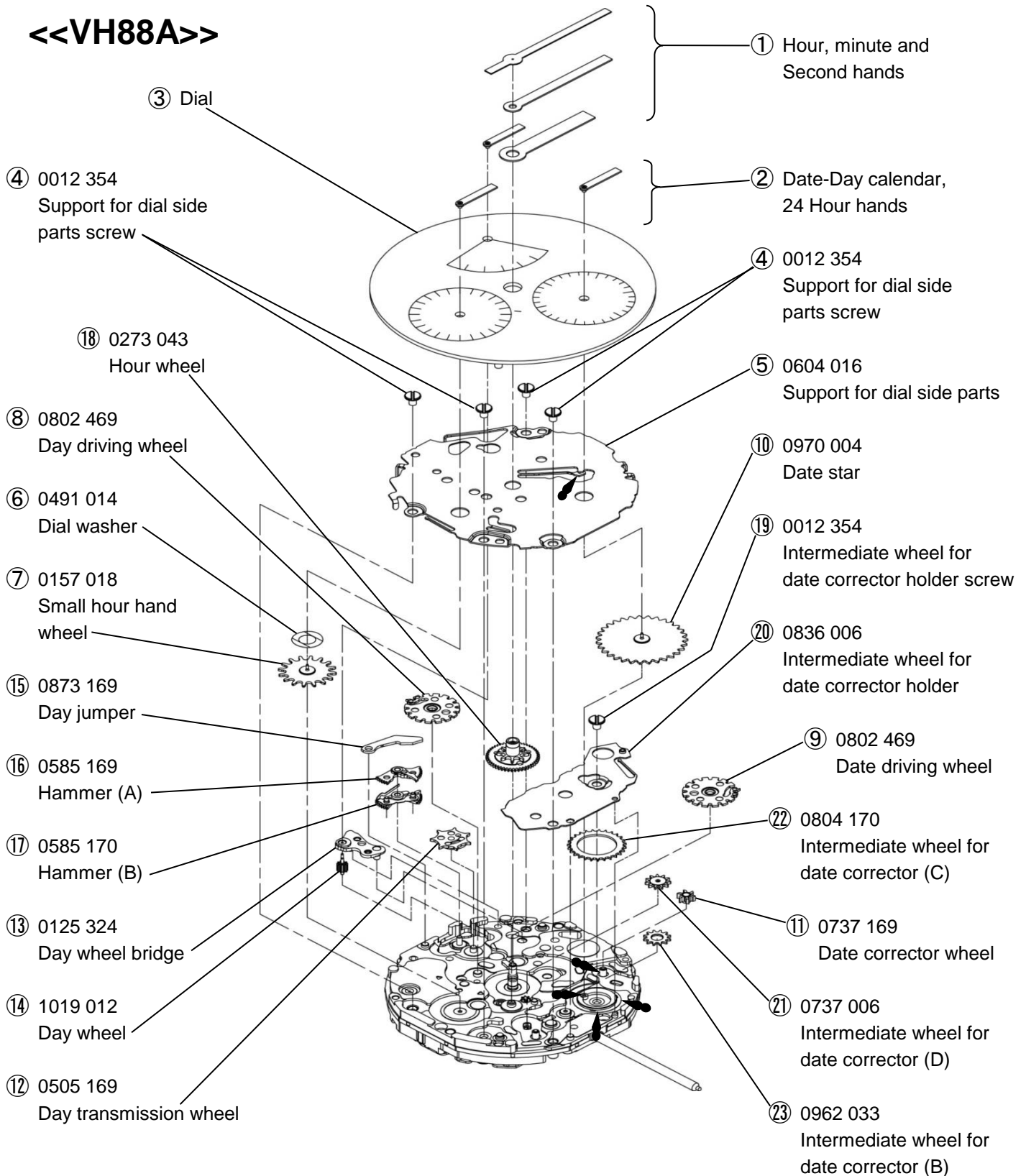

Disassembling procedures Figs. ① → ⑤①	Lubricating : Types of oil		A3a / Moebius 9010
Reassembling procedures Figs. ⑤① → ①			A2a / Moebius 9030
	Oil quantity		Normal quantity
			Sufficient quantity

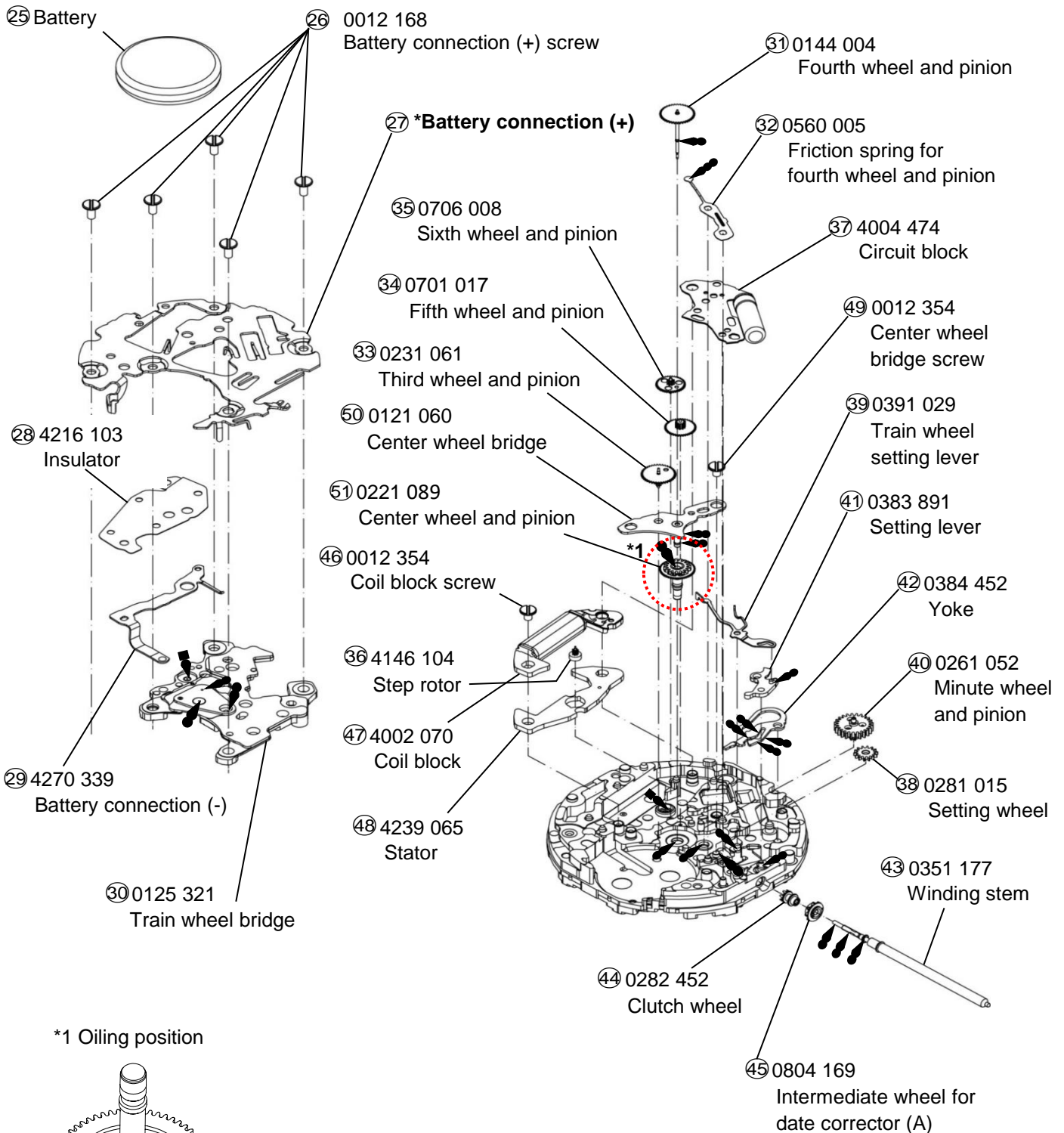

*Refer to pages 6 for each parts code

Remarks:

○ Different parts for each CAL.

Parts name	Parts code	VH83A	VH88A
⑦ Battery connection (+)	4268 076	○	—
	4268 078	—	○

*** All parts code are subject to change without notice.**

•The explanation here is only for the particular point of Cal.VH83A/VH88A

REMARKS ON DISASSEMBLING AND REASSEMBLING

(1) Day wheel

•How to install:

- ①Set Lever of Hammer (A) along the pin of the main plate.
- ②After confirm that gears of Hammer (A) and (B) are engaged each other, set Day wheel vertically.

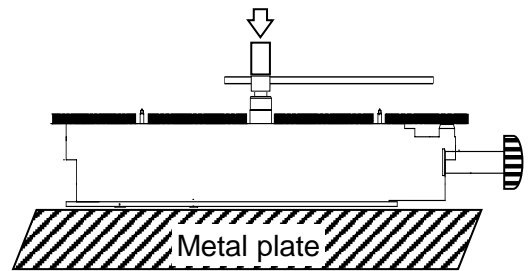
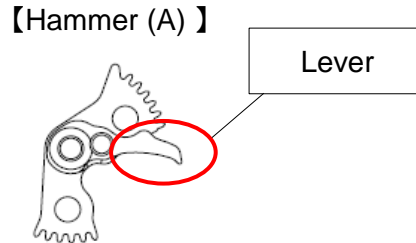
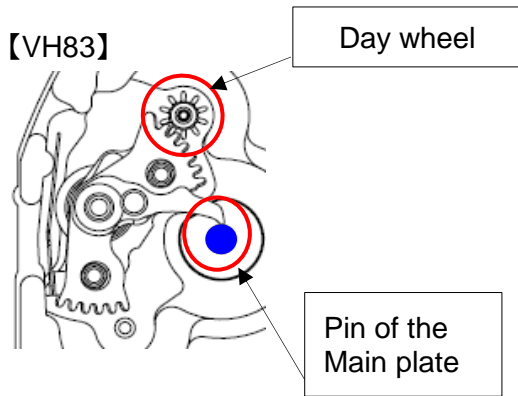

(2) HAND

•How to install hands:

Place the movement directly on a flat metal plate or such a hard plate when you install the hands.

Necessary procedure to setting hands:

- ①The state of movement is confirmed by the position of a right picture.
Pull out the crown to the second click position and rotate to set the position of Day transmission wheel and Support for dial side parts.
- ②Set the dial.
- ③Install the date calendar hand at the 12 o'clock position.
- ④Install the Day calendar hand at the first position.
- ⑤Pull out the crown to the second click position, and change the date by rotating the crown clockwise.
- ⑥Install the 24hour, hour, minute and second hands at the 12 o'clock position.

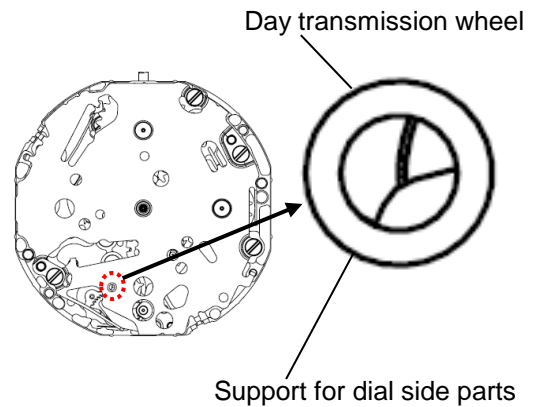

Necessary procedure to setting hands:

(3) Day calendar (Retrograde) hand

•Quick moving of Day calendar hand

The hand instantaneously returns from B position to A position when one week passes.

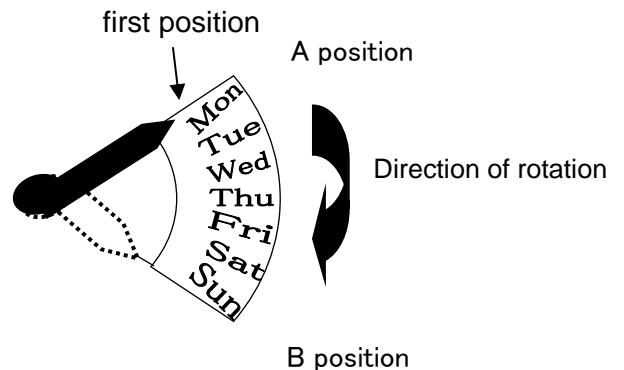

(4)Winding stem

- How to remove:
Pull out the winding stem while pushing the indented portion of the arrow.

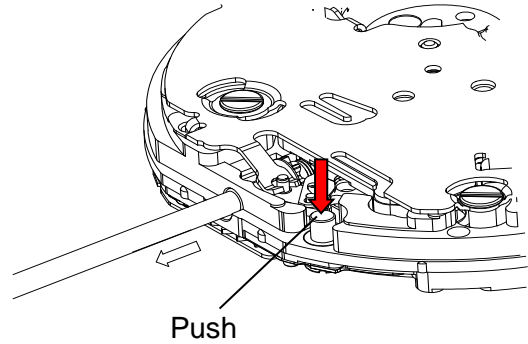

(5)Battery

- How to install:
Insert the battery in the aslant direction as shown by the arrow. Check that the battery connection (+) touches securely the side face of the battery.

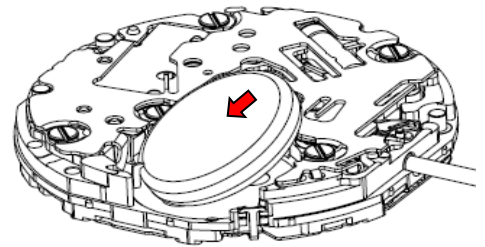

- How to remove:
Firstly slide the battery in the direction of the arrow with tweezers, and then lift the battery.

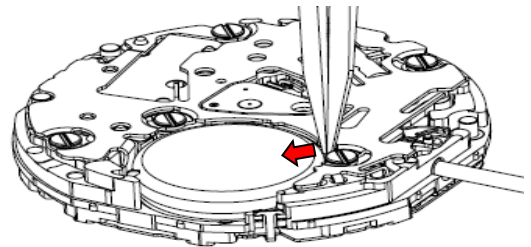

(6)Insulator

- How to set:
To insulate between the battery connection (+) and the battery connection (-), the insulator should be put at the two pins securely as bellow.

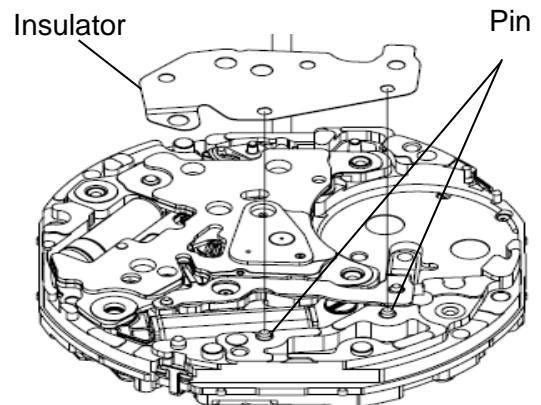

(7)Day jumper and Support for dial side parts

- Reassembling procedures
The support for dial side parts spring sets to the day jumper. (A position)

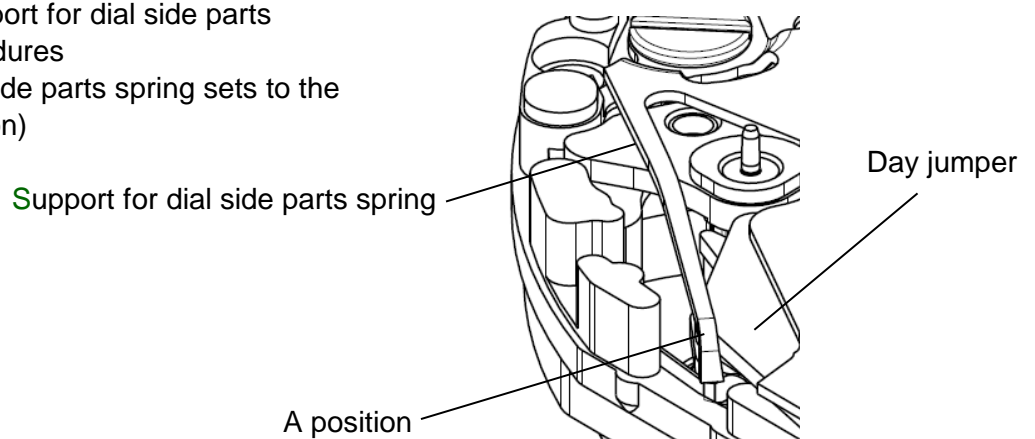

(8) Setting position (at the time of disassembling and reassembling)

• How to set the Date & Day driving wheels in the correct position:

Note:

Set the indicator finger of a Date & Day driving wheels to the setting position mark on the Main plate.

«Cal.VH83A setting position»

«Cal.VH88A setting position»

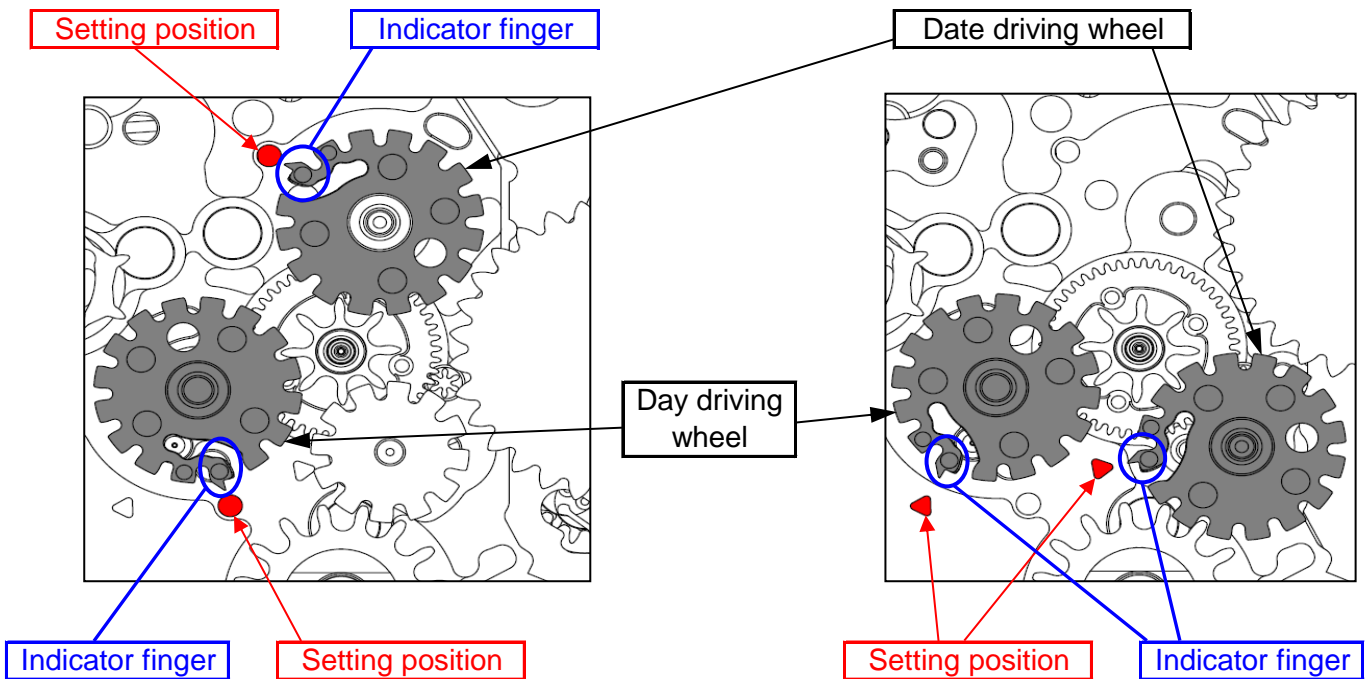
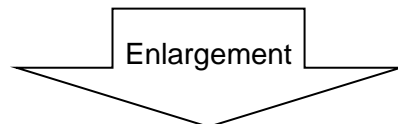
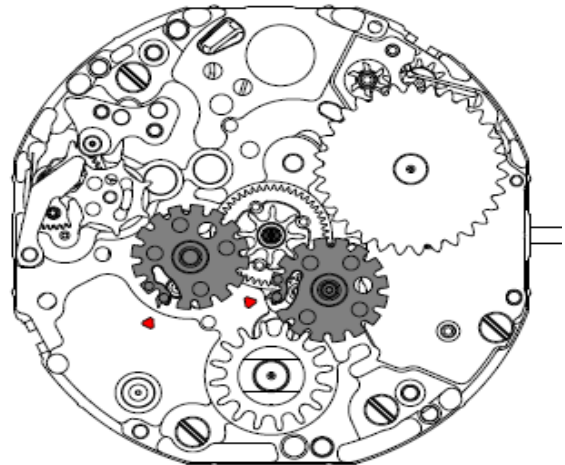
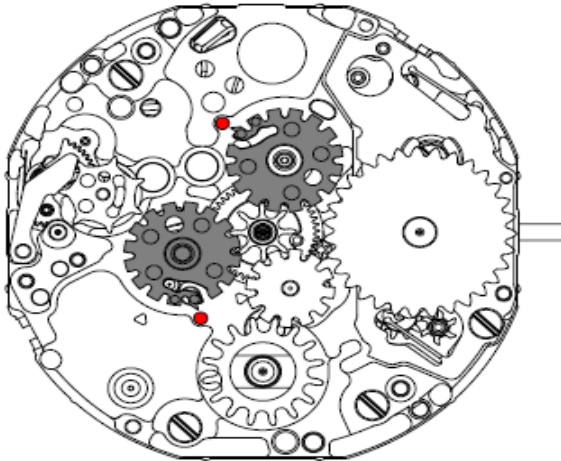

- How to assemble and set the Date & Day jumpers of the support of dial side parts:
There are two hooks on the support for dial side parts. (Fig.1)
First, assemble the two hooks on the support for dial side parts to the position of the built-in height A of the base plate. (Fig.2)
Set the Date & Day jumper to the teeth of the Date star & Day wheel.
Second, assemble the two hooks on the position of the built-in height B of the base plate. (Fig.3)

example VH83A

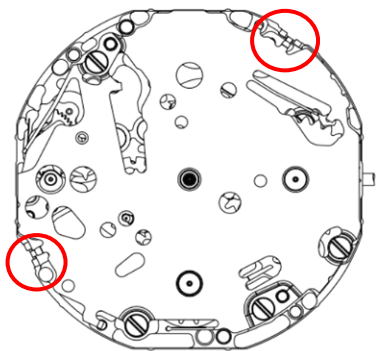

Fig.1 (example VH83A)

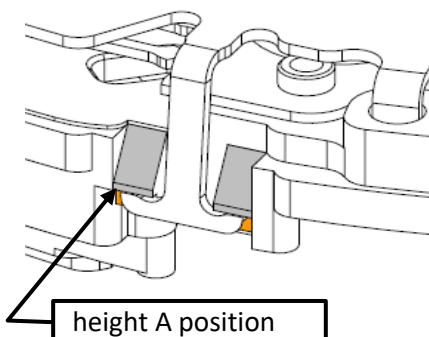

Fig.2 (built-in height A)

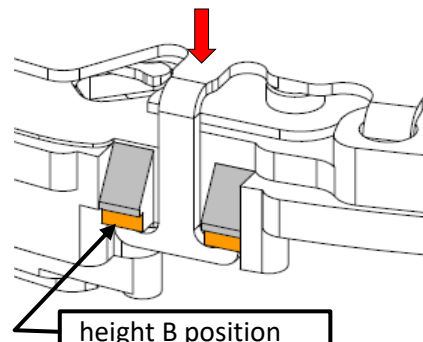
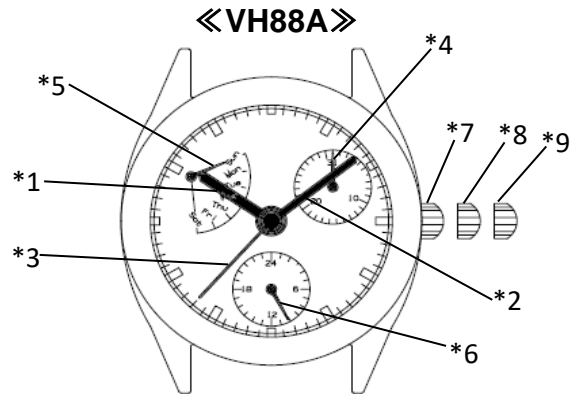
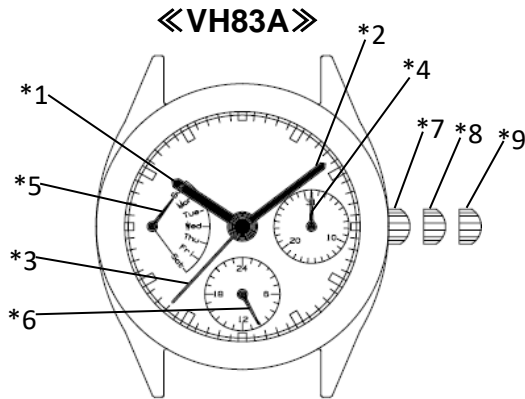

Fig.3 (built-in height B)

DISPLAY AND CROWN OPERATION



Note:

- | | | | |
|-----------------|------------------------|--|------------------|
| *1: Hour hand | *4: Date calendar hand | *7: Crown at normal position | *9: Second click |
| *2: Minute hand | *5: Day calendar hand | *8: First click | • Time setting |
| *3: Second hand | *6: 24 Hour hand | • Date setting (Quick change function) | |

TIME SETTING

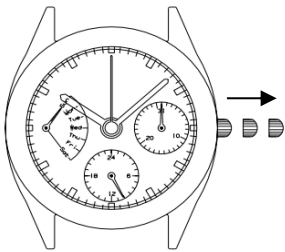

1.Pull out the crown to the second click when the second hand is at the 12 O'clock position.

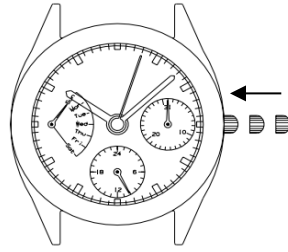

2.Push the crown back into the normal position in signal.

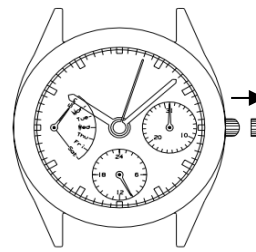

3.Pull out the crown to the first click. Turn the crown counter-clockwise to set the date.

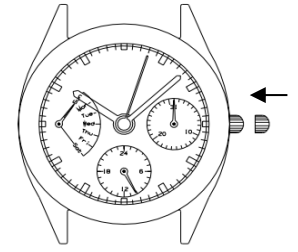

4.Push the crown back into the normal position.

Turn the crown rotation to set the day of the week.

Turn the crown to set the hour and minute hands to the time.
(Check that AM / PM is set correctly)

*Do not set the date between 10:00 PM and 2:00 AM

Otherwise the day could not change properly. If it is necessary to set the date during that time period, once change the time to any time except the period, and then set the date.

After that set the time correctly.

Notes in time setting of Cal.VH8 series

When time setting is done with counterclockwise, date hand might reverse but there is no problem for the function.

Please set the date by using quick change function when date showing is incorrect.