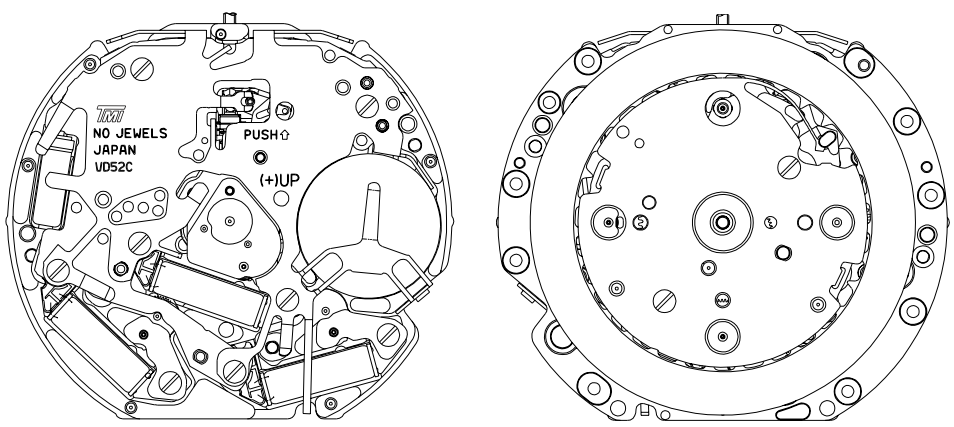

**TECHNICAL GUIDE
&
PARTS CATALOGUE**

Cal.VD52C

ANALOGUE QUARTZ

Item		Cal. No.	VD52C
Movement			
Movement size	Outside diameter	(φD)	(3H - 9H) (12H - 6H) φ29.50 mm × 26.00 mm × —
	Casing diameter	(φD)	(3H - 9H) (12H - 6H) φ28.80 mm × — × —
	Total height	4.57 mm	
Time indication		3 Hands (Hour, Minute, Second) Chronograph (Minute, Second) 24 hour indicator Calendar	
Driving system		Two pole stepping motor Step motor 3 pieces	
Additional mechanism		Electronic circuit reset switch Second setting device [Time] Indicated by the Hour, Minute, Second 24 hour hands [Stop watch] Up to 60 minutes in 1 second split time	
Antimagnetic		≥ 1600 A/m	
Accuracy		Less than ± 20 seconds : Monthly rate at normal temperature range	
Battery		SR920SW (SEIZAIKEN) Silver oxide battery φ9.5 × t 2.0 mm Battery life is approximately 3 years	
Measuring gate by quartz tester		Use 10 second gate *Set the winding stem with crown at the normal position	
Jewels		0 Jewel	

Disassembling procedures Figs. ① → ⑤④

Reassembling procedures Figs. ⑤④ → ①

Lubricating : Types of oil

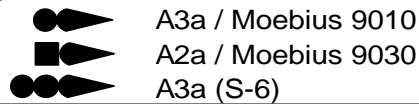

Oil quantity ○○ Normal quantity

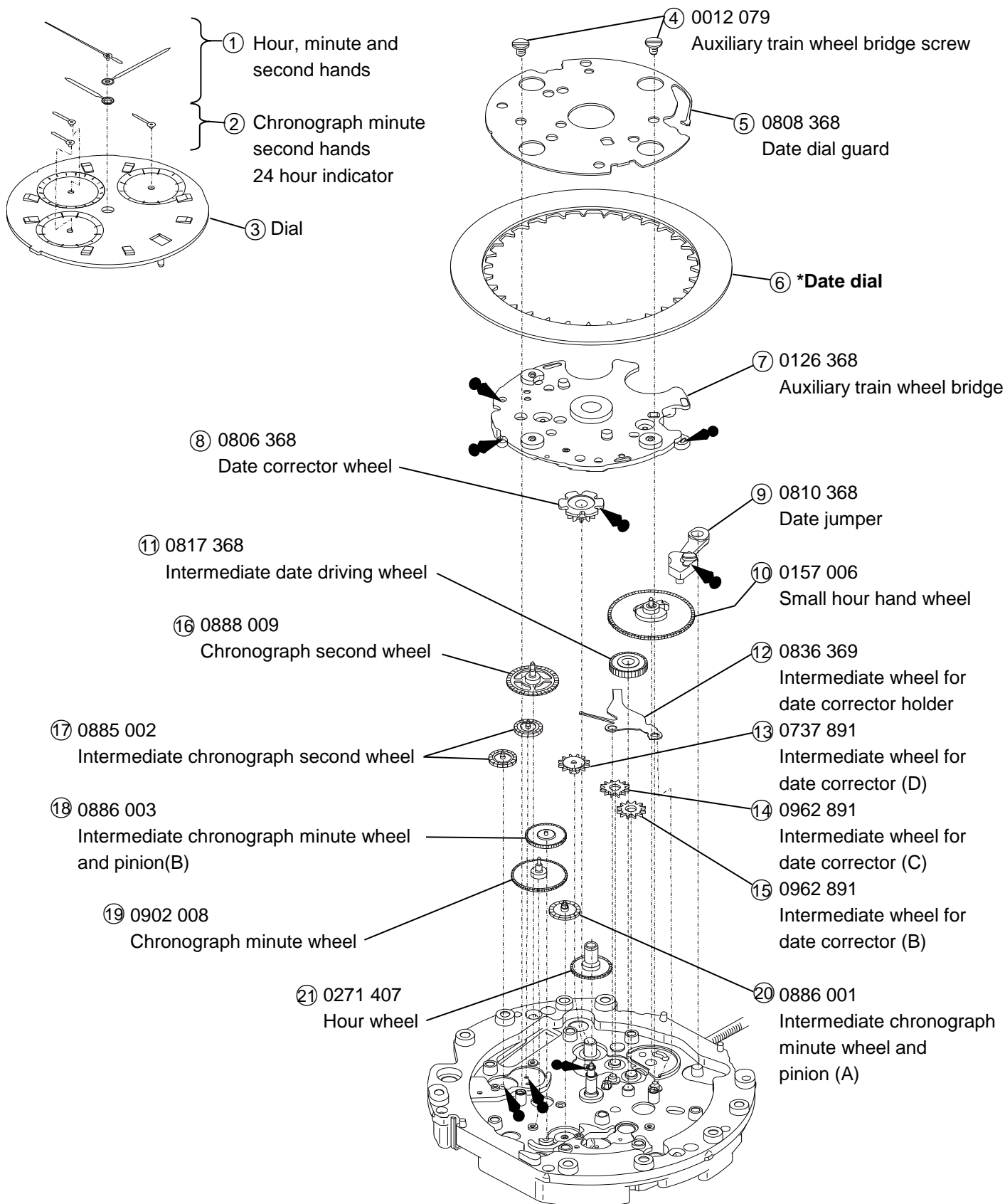





*Refer to page 5 for each parts code

Disassembling procedures Figs. ① → ⑤④





Reassembling procedures Figs. ⑤④ → ①

Lubricating : Types of oil

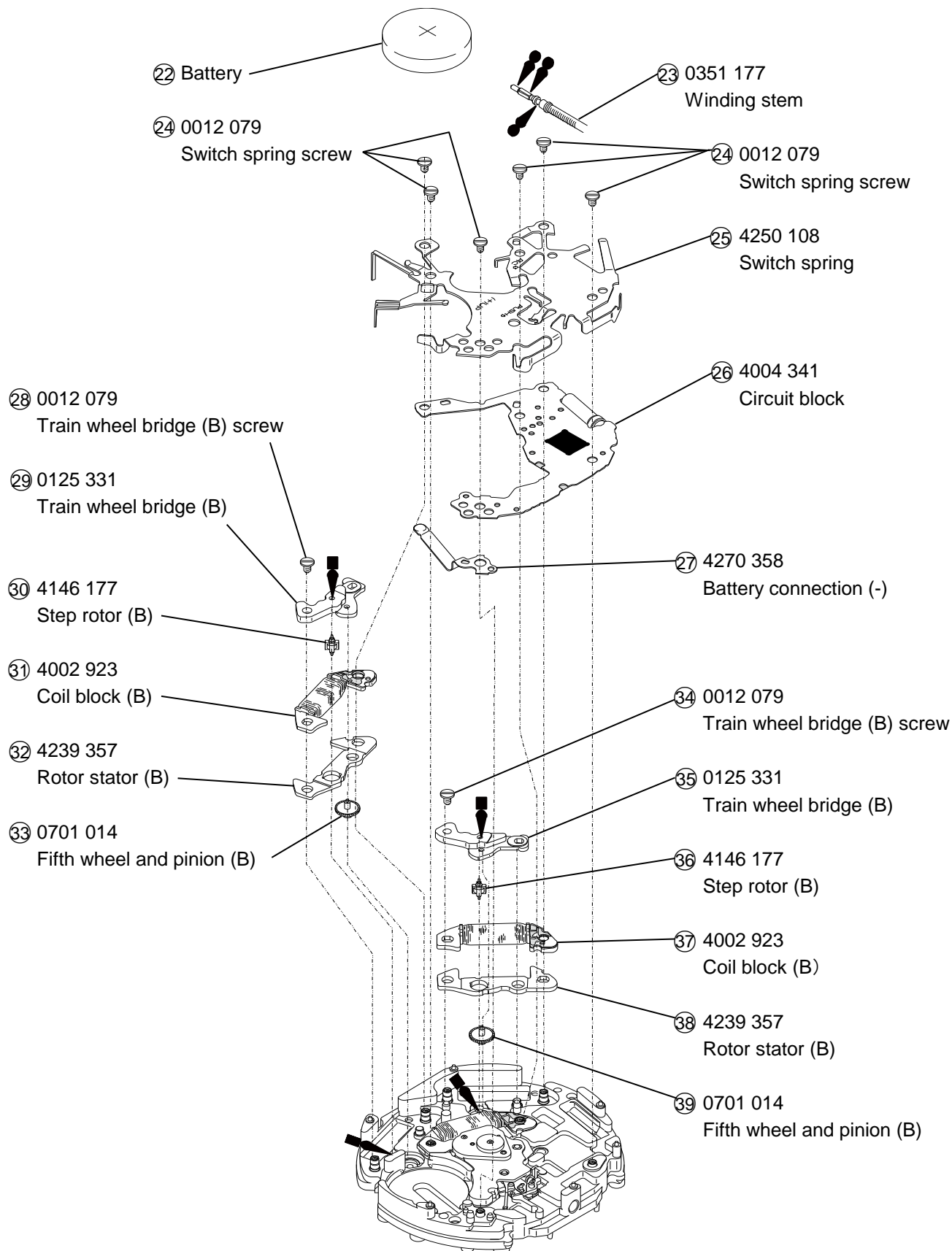
-  A3a / Moebius 9010
-  A2a / Moebius 9030
-  A3a (S-6)

Oil quantity  Normal quantity



Disassembling procedures Figs. ① → ⑤④	Lubricating : Types of oil
Reassembling procedures Figs. ⑤④ → ①	 A3a / Moebius 9010  A2a / Moebius 9030  A3a (S-6)
	Oil quantity  Normal quantity

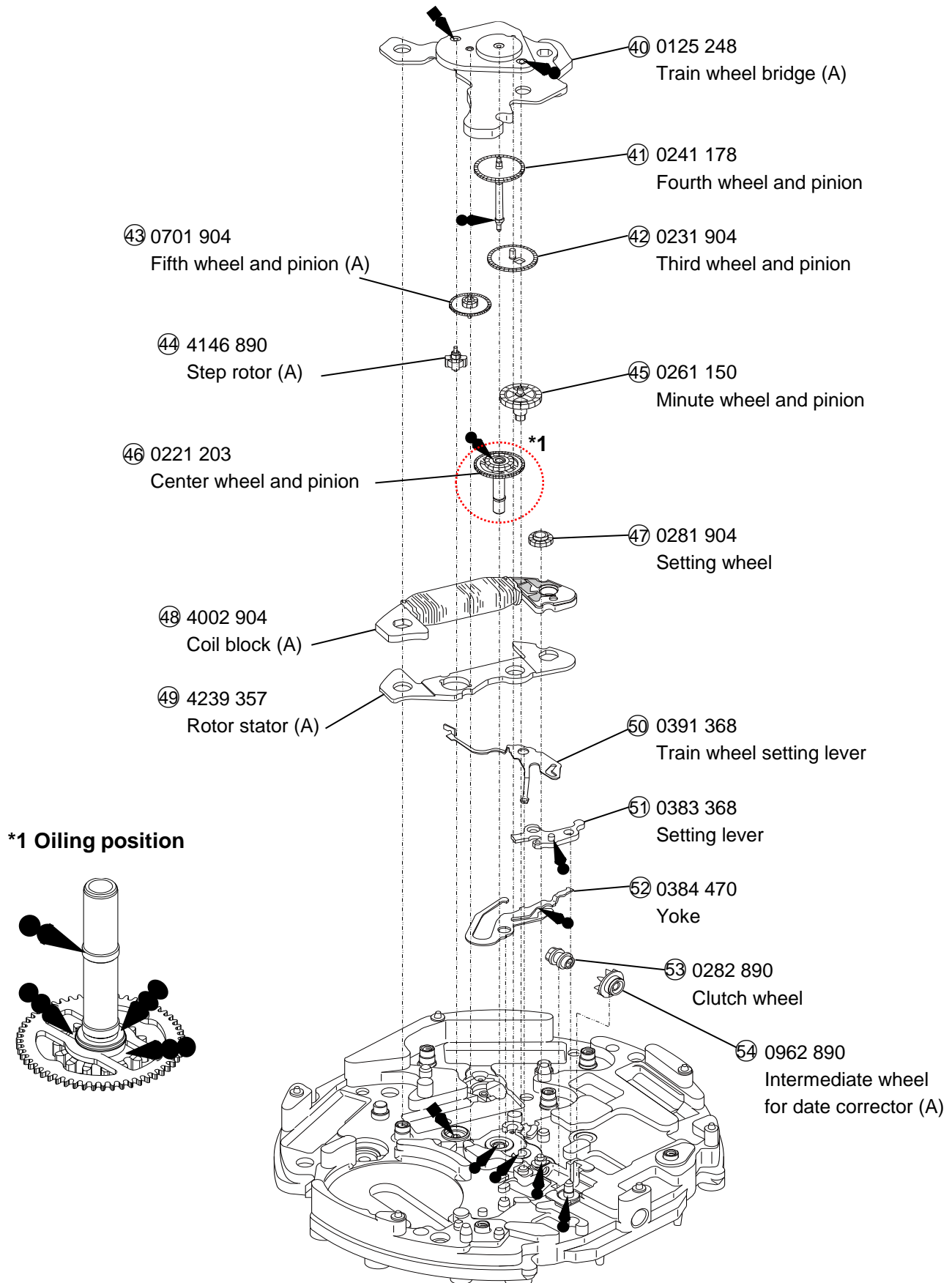

Remark :

⑥ Date dial

Part code	Position of crown	Position of date frame	Color of figure	Color of background
0878 165	3H	6H	Black	White

***All parts code are subject to change without notice.**

•The explanation here is only for the particular point of Cal.VD52C

1.REMARKS ON INSTALLING THE BATTERY

- 1) After the battery is replaced with a new one or after the battery is reinstalled following the repairing procedures, Be sure to touch the short-circuit the AC terminal of circuit block and the switch spring with conductive tweezers to reset the circuit as illustrated at right.

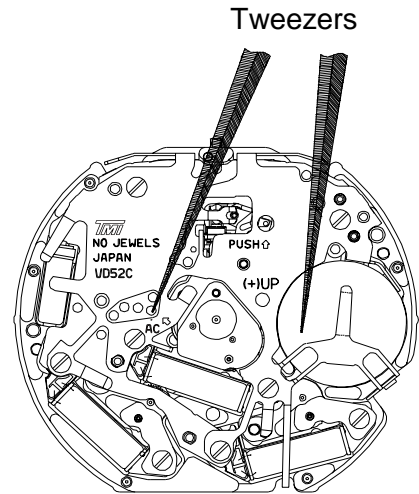

- 2) When the battery replaced with a new one, the time information stored in the built-in IC and the time indicated by the stopwatch hands do not correspond with each other. Reset the stopwatch hands to "0" position following the procedure below. If the stopwatch hands should move improperly, also follow the same procedure.

ORDER

- ① Pull the crown out to the second click.
- ② Keep buttons "A" and "B" pressed at the same time for 2 seconds, and then, release the buttons. The stopwatch second hand move back and returned to where it was.
- ③ Press button "A" or "B" to reset the stopwatch second and minute hands to "0" position.
 - * By pressing button "A", set the stopwatch second hand.
 - * By pressing button "B", set the stopwatch minute hand.
- ④ Turn the crown to set the hour, and minute and 24 hour hands to the desired time, and push the crown back in to the normal position.

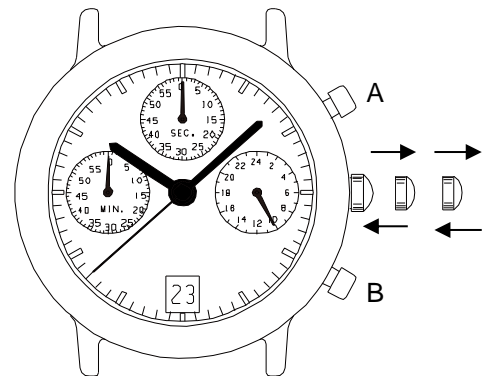

2.REMARKS ON DISASSEMBLING AND REASSEMBLING

(1) Hand

•How to install the hands

Please put on the metal plate so as to avoid 6 protrusions.(Right figure: place of red circle)

*Install the hour, minute and second hands at the "12" o'clock position.

*Install the chrono minute and second hands at the "0" o'clock position.

*Install the 24 hour indicator at the "24" position.

[Reference] The power of press hands

Minute & Hour Hands	< 5kg
Second Hand	< 5kg
Chrono Minute & Second	< 3kg
24 hour indicator	< 3kg

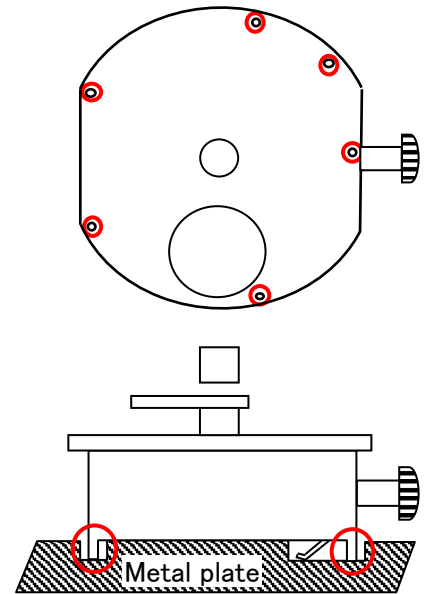

(2) Battery

•How to install the battery

① Remove the hook of the switch springs battery clamp portion.

② Insert the battery sideways, and have the hook of the switch springs battery clamp portion catch the main plate.

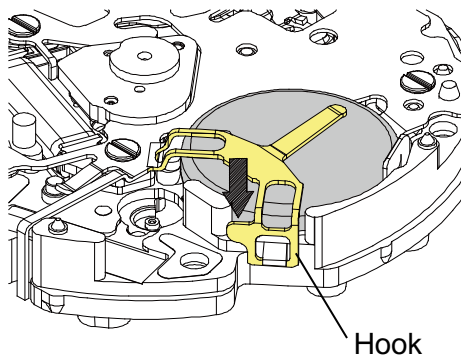

Battery clamp position

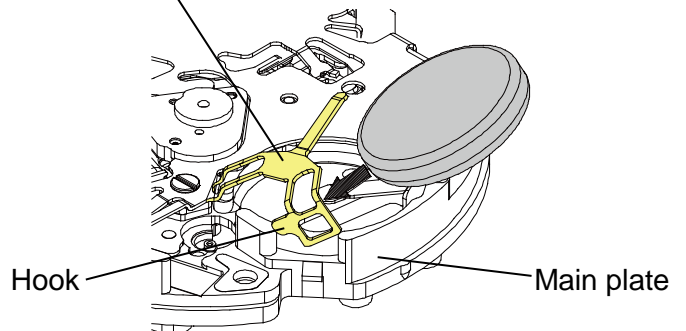

(3) Winding stem

•How to remove

While pushing the indented portion of the arrow, pull out the winding stem.

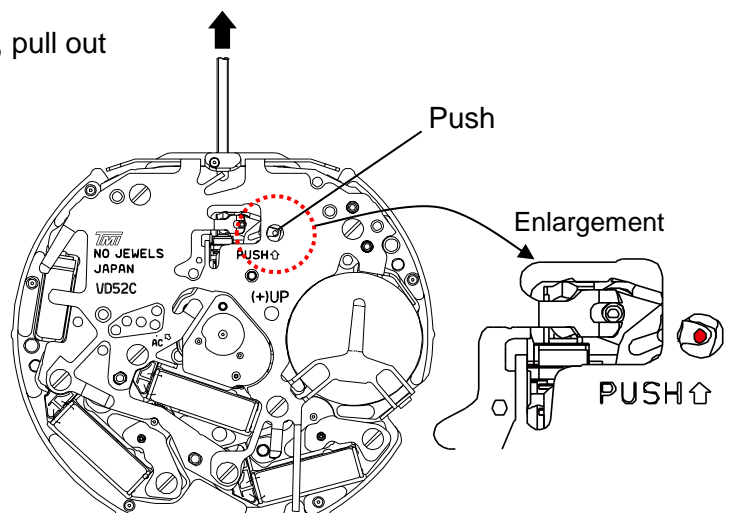

DISPLAY AND CROWN / BUTTON OPERATION

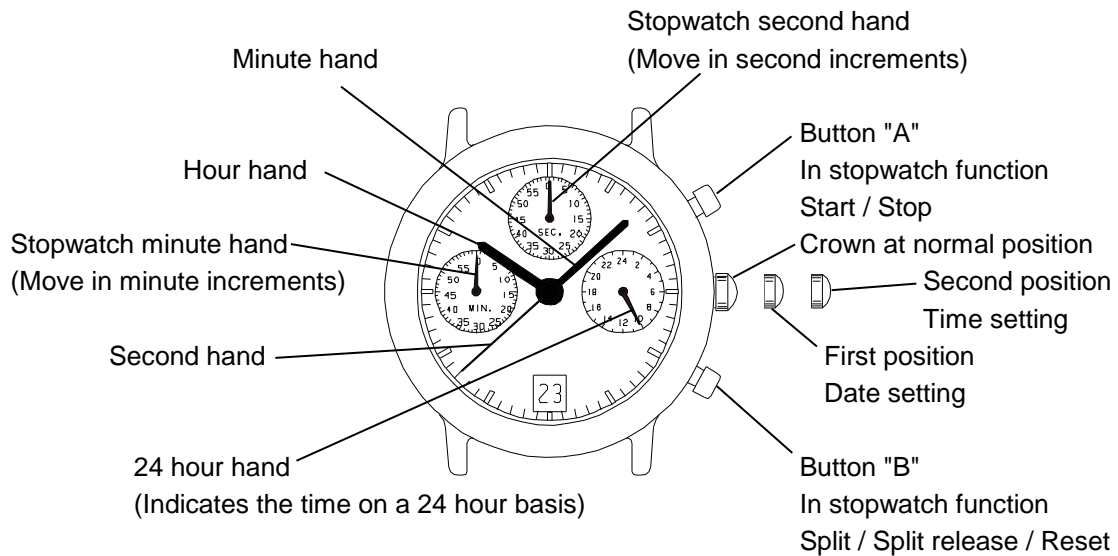

ADJUSTING THE STOPWATCH HAND POSITION

Before setting the time, check if the stopwatch second and minute hands are in the "0" (12 o'clock) position.

* If the stopwatch is in use, press the button in the following order to reset it, and then, check if the hands return to "0" position. (For details, see "HOW TO USE THE STOPWATCH")

- * If the stopwatch is counting : A → B
- * If the stopwatch is stopped : B
- * If the split time is displayed : B → A → B

If either of the stopwatch hands are not in the "0" position, reset them following the procedure below.

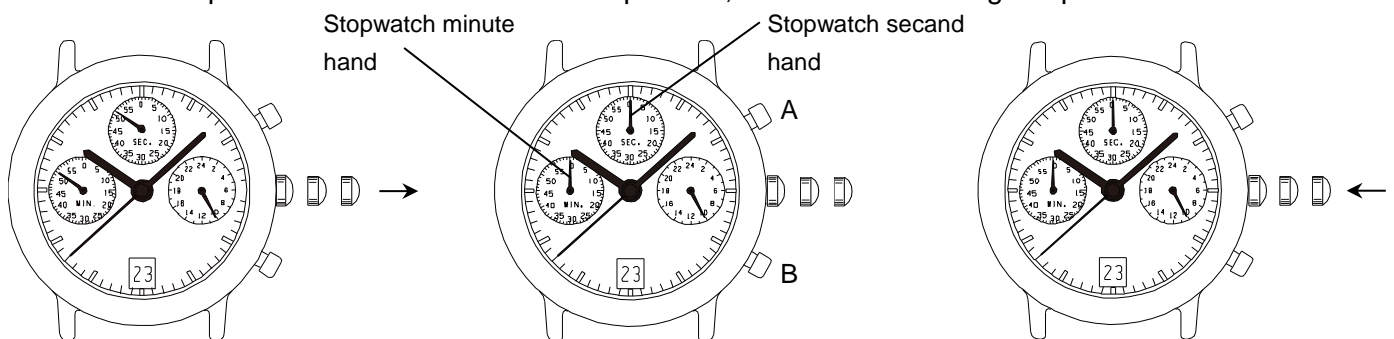

1. Pull the crown out to the second click.

2. Press button A or B to reset the stopwatch second and minute hands to "0" position.

3. Push the crown back to the normal position.

- *By pressing button A set the stopwatch second hand.
- *By pressing button B set the stopwatch minute hand.

- *The stopwatch minute hand moves correspondingly with the stopwatch second hand.
- *The hands move quickly if the respective buttons are kept pressed.

TIME SETTING

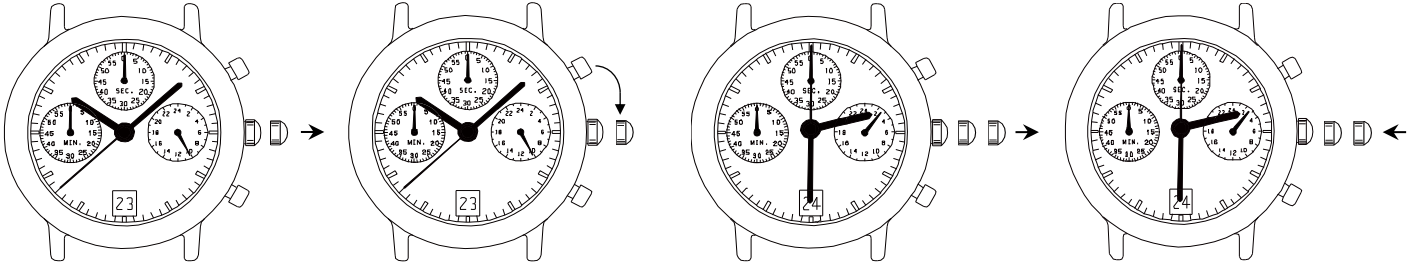

1.Pull out the crown to the first click.

2.Turn the crown clockwise until the previous day's date appears.

3.Pull out the crown to the second click when the second hand is at the 12 o'clock position. It will stop on the spot and advance the hour and minute hands by turning the crown. (Check that AM/PM is set correctly.)

4.Push the crown back in to the normal position in accordance with a time signal.

*When the crown is at the second click position. Do not press any button. Otherwise, the chronograph hands will move.

*Do not set the date between 9:00 P.M. and 1:00 A.M.

Otherwise, the day may not change properly. If it is necessary to set the date during that time period, First change the time to any time outside it, set the date and then reset the correct time.

HOW TO USE THE STOPWATCH

- The measurement time is indicated by the stopwatch hands that move independently of the center and 24 hour hands.
- The stopwatch can measure up to 60 minutes in second.

(Standard measurement)

Ex) 100m race (Press the buttons in the following order A → A → B)
 START → STOP (Finish) → RESET (Reset to "0'00")

Stopwatch second hand

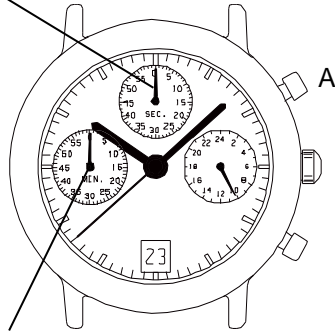

Stopwatch minute hand

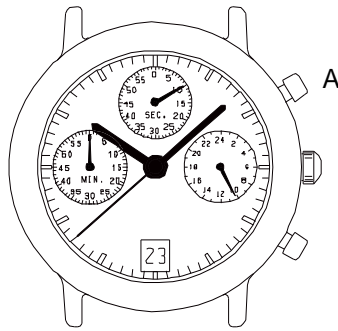

10 second

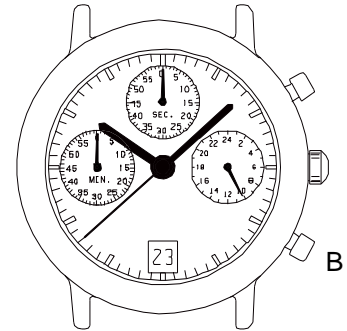

(Accumulated elapsed time measurement)

Ex) Basketball game (Press the buttons in the following order A → A / A → A → B)
 START (Start of game) → STOP (Time out) / RESTART (Restart of game) → STOP (Game over) → RESET

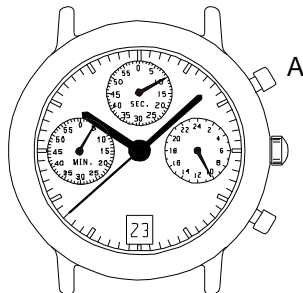
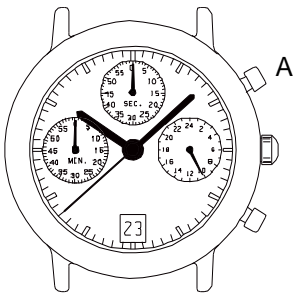

5 minutes 10 seconds

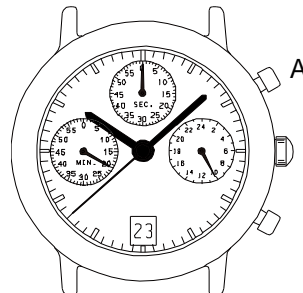

20 minutes 00 seconds

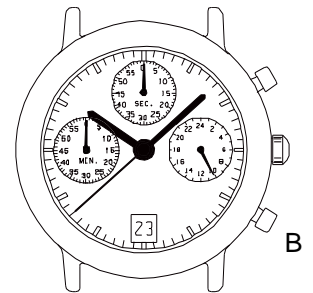

*Restart and stop of the stopwatch can be repeated as many times as necessary by pressing button A.

(Split time measurement)

Ex.) 5,000m race (Press the buttons in the following order A → B / B → A → B)

START → SPLIT / SPLIT RELEASE → STOP → RESET

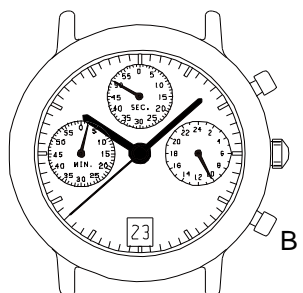
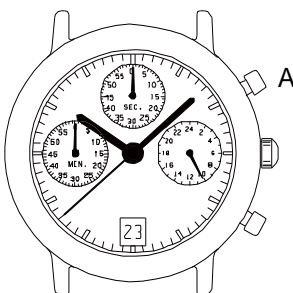

2 minutes 50 seconds

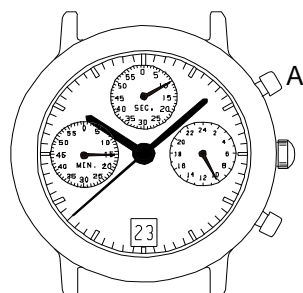

15 minutes 10 seconds

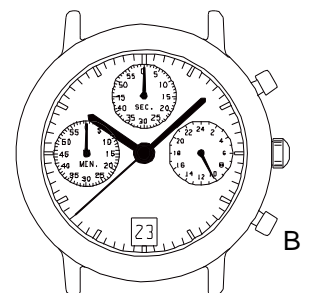

*Measurement and release of the split time can be repeated as many times as necessary by pressing button B.