



# Perfekt geschlossen



Magnetschließen

Magnetic Clasps

Schmuckschließen

Clasps

Arbandschließen

Clasps For Bracelets

Drehverschlüsse

Rotary Snaps

Wechselschließen

Interchangeable Clasps

Schnäpper

Bolts For Snaps

Münzfassungen

Coin Mountings

Schlüsselringe

Keyrings

Taschenuhrketten

Chains For Pocket Watches

# Magnetschließen

## Magnetic-Ball Clasps

### Magnetschließen „Langer-Classic“, Kugelform poliert

#### Magnetic-ball clasps polished

Magnetkugeln von höchster Qualität, poliert.

Ausführung / Execution		ø 6,0 mm	ø 8,0 mm	ø 11,0 mm	ø 13,0 mm	ø 16,0 mm
<b>Silber AG 925</b>	Art.-No.	<b>497 065</b>	<b>497 050</b>	<b>497 054</b>	<b>497 058</b>	<b>497 067</b>
	VPE	1   -	1   -	1   -	1   -	1   -
<b>Silber vergoldet</b>	Art.-No.	<b>497 365</b>	<b>497 350</b>	<b>497 354</b>	<b>497 358</b>	<b>497 367</b>
	VPE	1   -	1   -	1   -	1   -	1   -
<b>Gelbgold GG 585</b>	Art.-No.	-	<b>497 250</b>	<b>497 254</b>	<b>497 258</b>	-
	VPE	-	1   -	1   -	1   -	-
<b>Gelbgold GG 750</b>	Art.-No.	-	<b>497 450</b>	<b>497 454</b>	-	-
	VPE	-	1   -	1   -	-	-
<b>Weißgold WG 750</b>	Art.-No.	-	<b>497 950</b>	<b>497 954</b>	-	-
	VPE	-	1   -	1   -	-	-

### Aufsatz für Magnetschließen, poliert

#### Application "Tear Drops" for magnetic-ball clasps

Applikation „Tear Drops“ für Magnetkugeln 11,0 mm von Langer.

Unabhängig von der Beschaffenheit  
und Farbe der Oberfläche ermöglichen  
diese Applikationen eine vielfältige  
Gestaltung der klassischen Magnetkugeln.

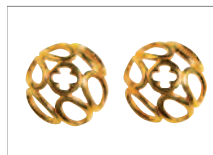

Ausführung / Execution		ø 11,0 mm
<b>Silber AG 925</b>	Art.-No.	<b>497 014</b>
	VPE	2   -
<b>Silber vergoldet</b>	Art.-No.	<b>497 314</b>
	VPE	2   -



### Exklusive Sortimente Magnetschließen

#### Exclusive assortments Magnetic-balls

Inhalt (sortiert in Box):

Je 4 Magnetschließen,  
davon 2 Magnetschließen matt, ø 8,0/11,0 mm und  
2 Magnetschließen poliert, ø 6,0/8,0 mm.

Ausführung / Execution		Sortim. / Assortments	Inhalt / Content
<b>Silber AG 925</b>	Art.-No.	<b>497 005</b>	<b>4 Stück, ø 6,0 bis 11,0 mm</b>
	VPE	1   -	
<b>Silber vergoldet</b>	Art.-No.	<b>497 305</b>	<b>4 Stück, ø 6,0 bis 11,0 mm</b>
	VPE	1   -	

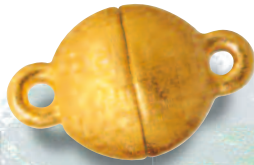

### Magnetschließen „Langer-Classic“, Kugelform matt

#### Magnetic-ball clasps matt

Magnetkugeln von höchster Qualität, matt.

Ausführung / Execution		ø 6,0 mm	ø 8,0 mm	ø 11,0 mm	ø 13,0 mm
<b>Silber AG 925</b>	Art.-No. VPE	<b>497 066</b> 1   -	<b>497 051</b> 1   -	<b>497 055</b> 1   -	<b>497 059</b> 1   -
<b>Silber vergoldet</b>	Art.-No. VPE	<b>497 366</b> 1   -	<b>497 351</b> 1   -	<b>497 355</b> 1   -	<b>497 359</b> 1   -
<b>Gelbgold GG 585</b>	Art.-No. VPE	-	-	<b>497 255</b> 1   -	-
<b>Gelbgold GG 750</b>	Art.-No. VPE	-	-	<b>497 455</b> 1   -	-
<b>Weißgold WG 750</b>	Art.-No. VPE	-	-	<b>497 955</b> 1   -	-



### Magnetschließen „Langer-Classic“, Kugelform brillantiert

#### Magnetic-ball clasps, frosted finish

Magnetkugeln von höchster Qualität, brillantiert.

Ausführung / Execution		ø 8,0 mm	ø 11,0 mm	ø 13,0 mm	ø 16,0 mm
<b>Silber AG 925</b>	Art.-No. VPE	<b>497 052</b> 1   -	<b>497 056</b> 1   -	<b>497 060</b> 1   -	<b>497 053</b> 1   -
<b>Silber vergoldet</b>	Art.-No. VPE	<b>497 352</b> 1   -	<b>497 356</b> 1   -	<b>497 360</b> 1   -	<b>497 353</b> 1   -



#### Vorteile der Magnetschließen

Magnetschließen von Langer sind von höchster Qualität, verhindern ein Reißen der Kette und lassen sich per Magnetkraft quasi von selbst schließen. Ihre einfache Handhabung und ihr formschönes Design machen sie bei Trägern jeden Alters äußerst beliebt.

#### Qualität

„Langer“-Schließen werden nach einem patentierten Verfahren hergestellt und erfüllen höchste Qualitätsansprüche. Die kräftigen Power-Magnete in den Edelmetallhülsen sind wasserdicht verschlossen und so vor Schweiß, Feuchtigkeit und Beschädigung geschützt.

#### Wichtige Hinweise

Beim Verkauf der Magnetschließen ist darauf hinzuweisen, dass empfindliche Personen mit Herzschrittmachern oder ähnlichem mit Ihrem Arzt Rücksprache halten, um eventuelle Beeinträchtigungen auszuschließen.

Auch dürfen Magnete nicht über 60° C erhitzt werden!



# Magnetschließen

## Magnetic-Ball Clasps and Magnetic Clasps

### Magnetschließen „Langer-Classic“, Kugelform schwarz

#### Magnetic-ball clasps, black

Magnetkugeln von höchster Qualität, schwarz, mit Diamantschliffeffekt.





			
Ausführung / Execution		poliert ø 10,0 mm	matt ø 10,0 mm
Silber Rugadec	Art.-No.	497 068	
	VPE	1	–
Silber Rugadec	Art.-No.	497 069	
	VPE	1	–



### Magnetschließen „Langer-Classic“, Kugelform, „Diamond Stars“

#### Magnetic-ball clasps „Diamond Stars“

Magnetkugeln von höchster Qualität, matt, mit Sterneffekt.



					
Ausführung / Execution		ø 12,0 mm	ø 12,0 mm	ø 12,0 mm	ø 14,0 mm
Silber AG 925	Art.-No.	497 027		497 028	
	VPE	1	–	1	–
Silber Rugadec	Art.-No.	–		497 029	
	VPE	–		1	–
					484 027
					1



### Magnetschließen „Langer-Classic“, Diskus, mehrreihig

#### Magnetic disc, multiple row

Magnetdiskus von höchster Qualität zum Auffädeln mehrreihiger Ketten und Armbänder. Matt und poliert.

			
Ausführung / Execution		matt und poliert ø 20,0 x 10,0 mm	
Silber AG 925	Art.-No.	497 012	
	VPE	1	–
Silber vergoldet	Art.-No.	497 312	
	VPE	1	–



### Magnetschließen „Langer-Classic“, Olivenform poliert

#### Magnetic-barrel clasps, polished

Magnetoliven von höchster Qualität, poliert.



Ausführung / Execution		ø 6,5 x L 12,0 mm	ø 8,0 x L 14,0 mm	ø 12,0 x L 22,0 mm
Edelstahl	Art.-No.	484 830		484 833
	VPE	1	–	1
Silber AG 925	Art.-No.	497 035		497 031
	VPE	1	–	1
Silber vergoldet	Art.-No.	497 335		497 331
	VPE	1	–	1

### Magnetschließen „Langer-Classic“, Olivenform matt

#### Magnetic-barrel clasps, matt

Magnetoliven von höchster Qualität, matt.



Ausführung / Execution		ø 6,5 x L 12,0 mm	ø 8,0 x L 14,0 mm	ø 12,0 x L 22,0 mm
Silber AG 925	Art.-No.	497 036		497 032
	VPE	1	–	1
Silber vergoldet	Art.-No.	497 336		497 332
	VPE	1	–	1

### Magnetschließen „Langer-Classic“, Kegelform

#### Magnetic clasps, conical

Magnetkegel von höchster Qualität.  
Poliert oder matt.

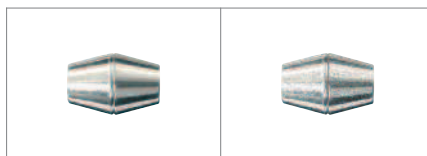

Ausführung / Execution		poliert		matt	
		ø 8,0 x L 12,0 mm		ø 8,0 x L 12,0 mm	
Silber AG 925	Art.-No.	484 035		484 036	
	VPE	1	–	1	–
Silber vergoldet	Art.-No.	484 335		484 336	
	VPE	1	–	1	–

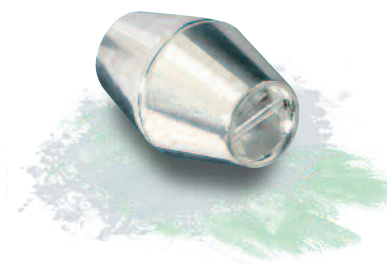

Federringe,  
Karabiner

Ohrstecker,  
Brisuren

Anhänger, Schlaufen,  
Sicherungen

Perlseide, Drähte,  
Zwischenteile

Schließen,  
Schnapper

Edelsteine,  
Schmucksteine

Perlen

Zargen,  
Chatons

Halbzeuge,  
Ketten

Hilfsmittel,  
Fachliteratur

# Magnetschließen

## Magnetic Clasps

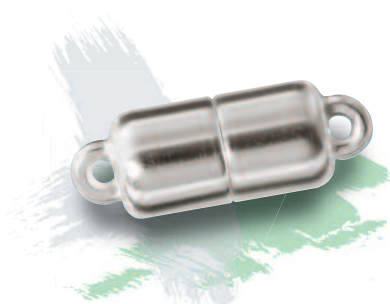

### Magnetschließen „Langer-Classic“, Zylinderform poliert

#### Magnetic cylinder clasps, polished

Magnetzylinder von höchster Qualität, poliert.

Ausführung / Execution		ø 6,0 x 12,0 mm	ø 7,0 x 12,3 mm	ø 9,0 x 14,5 mm
<b>Silber AG 925</b>	Art.-No.	<b>497 025</b>	<b>497 020</b>	<b>497 038</b>
	VPE	1   –	1   –	1   –
<b>Silber vergoldet</b>	Art.-No.	<b>497 325</b>	<b>497 320</b>	<b>497 338</b>
	VPE	1   –	1   –	1   –



### Magnetschließen „Langer-Classic“, Zylinderform matt

#### Magnetic cylinder clasps, matt

Magnetzylinder von höchster Qualität, matt.

Ausführung / Execution		ø 6,0 x 12,0 mm	ø 7,0 x 12,3 mm	ø 9,0 x 14,5 mm
<b>Silber AG 925</b>	Art.-No.	<b>497 024</b>	<b>497 049</b>	<b>497 037</b>
	VPE	1   –	1   –	1   –
<b>Silber vergoldet</b>	Art.-No.	<b>497 324</b>	<b>497 349</b>	<b>497 337</b>
	VPE	1   –	1   –	1   –



### Magnetschließen „Langer-Classic“, Zylinderform brillantiert

#### Magnetic cylinder clasps, frosted finish

Magnetzylinder von höchster Qualität, brillantiert.

Ausführung / Execution		ø 6,0 x 12,0 mm	ø 7,0 x 12,3 mm	ø 9,0 x 14,5 mm
<b>Silber AG 925</b>	Art.-No.	<b>497 026</b>	<b>497 044</b>	<b>497 039</b>
	VPE	1   –	1   –	1   –
<b>Silber vergoldet</b>	Art.-No.	<b>497 326</b>	<b>497 344</b>	<b>497 339</b>
	VPE	1   –	1   –	1   –

### Magnetschließen Bajonett-/Zylinderform Magnetic clasps bayonet

Zylinderform mit offenen Enden zum Ankleben von Kautschuk.  
Länge: 22 mm.

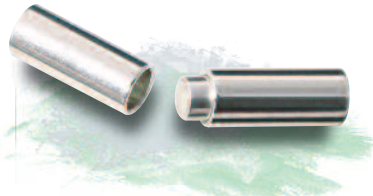

Ausführ. / Execution	Außen-	ø 3,0 mm	ø 3,5 mm	ø 4,5 mm
	Innen-	ø 2,5 mm	ø 3,0 mm	ø 4,0 mm
<b>Edel- stahl</b>	Art.-No.	<b>484 852</b>	<b>484 853</b>	<b>484 854</b>
	VPE	1   -	1   -	1   -
<b>Silber AG 925</b>	Art.-No.	<b>484 052</b>	<b>484 053</b>	<b>484 054</b>
	VPE	1   -	1   -	1   -

### Magnet-Armbandschließen Magnetic clasps for bracelets

Einhändig zu öffnende und sicher schließende Kombination  
aus Schiebe- und Magnetverschluss. Poliert.

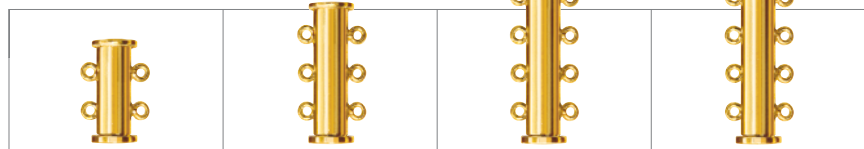

Ausführung / Execution	2-reihig		3-reihig		4-reihig		5-reihig	
	L 13,5 x B 5,0 mm		L 18,5 x B 5,0 mm		L 23,5 x B 5,0 mm		L 28,7 x B 5,0 mm	
<b>Silber AG 925</b>	Art.-No.	<b>497 022</b>	<b>497 023</b>	<b>497 021</b>	<b>497 018</b>			
	VPE	1   -	1   -	1   -	1   -			
<b>Silber vergoldet</b>	Art.-No.	<b>497 322</b>	<b>497 323</b>	<b>497 321</b>	<b>497 318</b>			
	VPE	1   -	1   -	1   -	1   -			
<b>Gelbgold GG 585</b>	Art.-No.	<b>497 222</b>	<b>497 223</b>	-	-			
	VPE	1   -	1   -	-	-			

### Magnetschließen Kastenform, mit und ohne Öse Magnetic clasps square for bracelets

Die Lieferung der Schließe erfolgt zerlegt,  
dadurch wird das Lötten an der Schließe ermöglicht.  
Höhe: 3,0 mm.

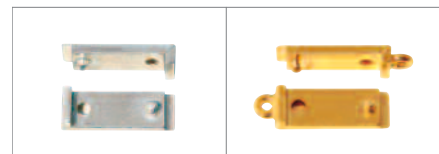

Ausführung / Execution	ohne Öse		mit Öse	
	L 15,0 x B 5,0 mm		L 15,0 x B 5,0 mm	
<b>Silber AG 925</b>	Art.-No.	<b>497 016</b>	<b>497 017</b>	
	VPE	1   -	1   -	
<b>Silber vergoldet</b>	Art.-No.	<b>497 316</b>	<b>497 317</b>	
	VPE	1   -	1   -	
<b>Gelbgold GG 585</b>	Art.-No.	<b>497 216</b>	<b>497 217</b>	
	VPE	1   -	1   -	

**Erst ganz am Schluss wird  
der lose gelieferte Magnet  
unwiderruflich in die Schließe eingesetzt!**

Federringe,  
Karabiner

Ohrstecker,  
Brisuren

Anhänger, Schlaufen,  
Sicherungen

Perlenseide, Drähte,  
Zwischenteile

Schließen,  
Schnapper

Edelsteine,  
Schmucksteine

Perlen

Zargen,  
Chatons

Halbzeuge,  
Ketten

Hilfsmittel,  
Fachliteratur

# Magnetschließen

## Magnetic Clasps



### Eine neue Generation

von Kettenschließen für Stein- und Perlketten. Komfortable Magnettechnik, hochwertige Ausführung und kreatives Design. Alle Schließen sind gegossen und rhodiniert bzw. vergoldet.

### Magnetschließen, Linsenform

#### Magnetic clasps

Matt, Oberseite gerillt.



Ausführung / Execution		Linsenform			
		ø 22,0 mm		ø 30,0 mm	
<b>Silber rhodin.</b>	Art.-No.	<b>484 060</b>		<b>484 061</b>	
	VPE	1	–	1	–
<b>Silber vergoldet</b>	Art.-No.	<b>484 360</b>		<b>484 361</b>	
	VPE	1	–	1	–

### Magnetschließen, Linsenform

#### Magnetic clasps

Matt, Oberseite mit Swarovski-Steinen und gerillt.

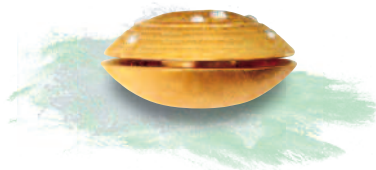

Execution		mit Swarovski Steinen	
		ø 22,0 mm	
<b>Silber rhodin.</b>	Art.-No.	<b>484 062</b>	
	VPE	1	–
<b>Silber vergoldet</b>	Art.-No.	<b>484 362</b>	
	VPE	1	–



**Magnetschließen, Schneckenform**  
**Magnetic clasps**

Oberfläche matt.



Ausführung / Execution		L 28,0 x B 24,0 mm		L 32,0 x B 26,0 mm	
<b>Silber rhodin.</b>	Art.-No. VPE	<b>484 064</b>		<b>484 065</b>	
		1	–	1	–
<b>Silber vergoldet</b>	Art.-No. VPE	<b>484 364</b>		<b>484 365</b>	
		1	–	1	–

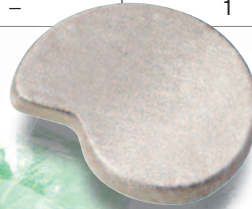

Federlinge,  
Karabiner

Ohrstecker,  
Brisuren

Anhänger, Schlaufen,  
Sicherungen

Perlseide, Drähte,  
Zwischenteile

**Schließen,  
Schnapper**

Edelsteine,  
Schmucksteine

Perlen

Zargen,  
Chatons

Halbzeuge,  
Ketten







Hilfsmittel,  
Fachliteratur

### Kugelschließen / Ball clasps

Absolute Klassiker unter den hochwertigen Verschlüssen. Kugelschließen mit zuverlässigen Mechaniken in verschiedenen attraktiven Oberflächen.



### Kugelschließen poliert Ball clasps, shiny

Ausführung / Execution		ø 6,0 mm	ø 7,0 mm	ø 8,0 mm	
<b>Silber rhodin.</b>	Art.-No.	<b>496 022</b>	<b>496 026</b>	<b>496 023</b>	
	VPE	1   -	1   -	1   -	
<b>Silber vergoldet</b>	Art.-No.	<b>496 322</b>	<b>496 326</b>	<b>496 323</b>	
	VPE	1   -	1   -	1   -	
<b>Gelbgold GG 375</b>	Art.-No.	<b>496 122</b>	<b>496 126</b>	<b>496 123</b>	
	VPE	1   -	1   -	1   -	
<b>Gelbgold GG 585</b>	Art.-No.	<b>496 222</b>	<b>496 226</b>	<b>496 223</b>	
	VPE	1   -	1   -	1   -	
<b>Gelbgold GG 750</b>	Art.-No.	<b>496 422</b>	<b>496 426</b>	<b>496 423</b>	
	VPE	1   -	1   -	1   -	
<b>Rotgold RG 585</b>	Art.-No.	-	-	<b>496 923</b>	
	VPE	-	-	1   -	
					
Ausführung / Execution		ø 10,0 mm	ø 13,0 mm	ø 15,0 mm	ø 20,0 mm
<b>Silber rhodin.</b>	Art.-No.	<b>496 024</b>	<b>496 025</b>	<b>496 028</b>	<b>496 029</b>
	VPE	1   -	1   -	1   -	1   -
<b>Silber vergoldet</b>	Art.-No.	<b>496 324</b>	<b>496 325</b>	<b>496 328</b>	<b>496 329</b>
	VPE	1   -	1   -	1   -	1   -
<b>Gelbgold GG 375</b>	Art.-No.	<b>496 124</b>	-	-	-
	VPE	1   -	-	-	-
<b>Gelbgold GG 585</b>	Art.-No.	<b>496 224</b>	-	-	-
	VPE	1   -	-	-	-
<b>Gelbgold GG 750</b>	Art.-No.	<b>496 424</b>	-	-	-
	VPE	1   -	-	-	-
<b>Rotgold RG 585</b>	Art.-No.	<b>496 924</b>	-	-	-
	VPE	1   -	-	-	-
					



**Kugelschließen matt**  
Ball clasps, matt

Ausführung / Execution		ø 6,0 mm	ø 8,0 mm			
<b>Silber rhodin.</b>	Art.-No. VPE	495 036 1   -	495 040 1   -			
<b>Silber vergoldet</b>	Art.-No. VPE	495 336 1   -	495 340 1   -			
<b>Gelbgold GG 375</b>	Art.-No. VPE	-	496 118 1   -			
<b>Gelbgold GG 585</b>	Art.-No. VPE	-	496 218 1   -			
<b>Weißgold WG 585</b>	Art.-No. VPE	-	496 618 1   -			
						
Ausführung / Execution		ø 10,0 mm	ø 13,0 mm	ø 15,0 mm	ø 17,0 mm	ø 20,0 mm
<b>Silber rhodin.</b>	Art.-No. VPE	495 037 1   -	495 038 1   -	495 080 1   -	495 039 1   -	495 035 1   -
<b>Silber vergoldet</b>	Art.-No. VPE	495 337 1   -	495 338 1   -	495 380 1   -	495 339 1   -	495 335 1   -
<b>Gelbgold GG 375</b>	Art.-No. VPE	496 120 1   -	-	-	-	-
<b>Gelbgold GG 585</b>	Art.-No. VPE	496 220 1   -	-	-	-	-
<b>Weißgold WG 585</b>	Art.-No. VPE	496 620 1   -	-	-	-	-

Federringe,  
Karabiner

Ohrstecker,  
Brisuren

Anhänger, Schlaufen,  
Sicherungen

Perlseide, Drähte,  
Zwischenteile

**Schließen,  
Schnapper**

Edelsteine,  
Schmucksteine

Perlen

Zargen,  
Chatons

Halbzeuge,  
Ketten

Hilfsmittel,  
Fachliteratur

# Schmuckschließen



## Ball Clasps

### Kugelschließen „Saturn“ Ball clasps “Saturn”



					
Ausführung / Execution		ø 10,0 mm	ø 10,0 mm	ø 11,0 mm	ø 12,0 mm
<b>Silber rhodin.</b>	Art.-No.	<b>469 055</b>		<b>495 045</b>	
	VPE	1	–	1	–
<b>Silber vergoldet</b>	Art.-No.	–		–	
	VPE	–		–	
<b>Gelbgold GG 585</b>	Art.-No.	–		<b>499 205</b>	
	VPE	–		1	–
<b>Weißgold WG 585</b>	Art.-No.	–		<b>499 605</b>	
	VPE	–		1	–
<b>Rotgold RG 585</b>	Art.-No.	–		<b>499 905</b>	
	VPE	–		1	–

### Kugelschließen matt, mit Brillanten W/SI Ball clasps, matt, with diamonds



				
Ausführ. / Execution	Gold-Brill.	0,03 ct (6 Br W/SI)	0,08 ct (8 Br W/SI)	0,12 ct (12 Br W/SI)
		ø 9,0 mm	ø 10,0 mm	ø 14,0 mm
<b>Gelbgold GG 585</b>	Art.-No.	<b>499 211</b>		<b>499 212</b>
	VPE	1	–	1
<b>Weißgold WG 585</b>	Art.-No.	<b>499 611</b>		<b>499 612</b>
	VPE	1	–	1

### Kugelschließen Sterneffekt Ball clasps, star effect

			
Ausführung / Execution		ø 8,0 mm	ø 10,0 mm
<b>Silber AG 925</b>	Art.-No.	<b>495 047</b>	
	VPE	1	–
		<b>495 048</b>	–
		1	–





### Kugelschließen, Fantasie

Ball clasps, fantasy

Ausführung / Execution		brillantiert	gepunktet		gemustert
		ø 10,0 mm	ø 10,0 mm	ø 13,0 mm	ø 13,0 mm
<b>Silber AG 925</b>	Art.-No.	-	-	<b>469 050</b>	
	VPE	-	-	1	-
<b>Gelbgold GG 585</b>	Art.-No.	<b>499 203</b>	<b>469 258</b>	-	-
	VPE	1	-	-	-
<b>Weißgold WG 585</b>	Art.-No.	<b>499 603</b>	-	-	-
	VPE	1	-	-	-



### Kugelschließen durchbrochen

Ball clasps, openwork

Ausführung / Execution		ø 9,0 mm	ø 12,0 mm	ø 13,0 mm
<b>Silber rhodin.</b>	Art.-No.	<b>495 043</b>	<b>469 052</b>	<b>469 053</b>
	VPE	1	-	1
<b>Silber vergoldet</b>	Art.-No.	<b>495 343</b>	<b>469 352</b>	<b>469 353</b>
	VPE	1	-	1

### Olivenschließen durchbrochen

Olive-type clasps, openwork

Mit Netzende zum Verknöten der Perlseide, gelb plattiert.

Ausführung / Execution		poliert	matt
		ø 11,0 x L 20,0 mm	ø 16,5 x L 20,5 mm
<b>Silber rhodin.</b>	Art.-No.	<b>469 060</b>	<b>469 061</b>
	VPE	1	-



Federringe,  
Karabiner

Ohrstecker,  
Brisuren

Anhänger, Schlaufen,  
Sicherungen

Perlseide, Drähte,  
Zwischenteile

Schließen,  
Schnapper

Edelsteine,  
Schmucksteine

Perlen



Zargen,  
Chatons

Halbzeuge,  
Ketten

Hilfsmittel,  
Fachliteratur



### Olivenschließen in verschiedenen Ausführungen

Olive-type clasps, different types

					
Ausführung / Execution		Fantasie ø 10,0 x L 14,0 mm	durchbrochen ø 10,0 x L 14,0 mm    ø 12,0 x L 20,0 mm		Nugget ø 9,0 x L 16,0 mm
Silber rhodin.	Art.-No.	469 076	469 077	469 078	469 069
	VPE	1   -	1   -	1   -	1   -
Silber vergoldet	Art.-No.	-	469 377	-	469 369
	VPE	-	1   -	-	1   -

### Olivenschließen poliert

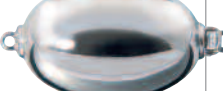

Olive-type clasps, polished

					
Ausführung / Execution		B 10,0 x L 12,0 mm	B 12,0 x L 14,0 mm	B 13,0 x L 16,0 mm	B 16,0 x L 23,0 mm
Silber rhodin.	Art.-No.	499 006	499 008	469 072	469 073
	VPE	1   -	1   -	1   -	1   -
Gelbgold GG 585	Art.-No.	499 206	499 208	-	-
	VPE	1   -	1   -	-	-
Rotgold RG 585	Art.-No.	499 906	-	-	-
	VPE	1   -	-	-	-

### Olivenschließen matt

Olive-type clasps, matt



			
Ausführung / Execution		ø 10,0 x L 12,0 mm	ø 12,0 x L 14,0 mm
Gelbgold GG 375	Art.-No.	-	495 188
	VPE	-	1   -
Gelbgold GG 585	Art.-No.	496 288	495 288
	VPE	1   -	1   -
Weißgold WG 585	Art.-No.	496 688	495 688
	VPE	1   -	1   -



### Tonnenschließen Barrel-type clasps

1-reihig.

Ausführung / Execution		matt		durchbrochen	
		ø 7,0 x L 10,0 mm		ø 5,8 x L 10,5 mm	
				ø 7,4 x L 10,8 mm	
				ø 6,0 x L 9,8 mm	
<b>Silber rhodin.</b>	Art.-No.	<b>495 030</b>		<b>495 032</b>	
	VPE	1	-	1	-
				<b>495 034</b>	
				1	
				<b>495 033</b>	
		1		-	

### Tonnenschließen Barrel-type clasps

Ausführung / Execution		matt		Sterneffekt
		B 4,0 x L 10,0 mm		B 6,0 x L 11,0 mm
		B 5,0 x L 14,0 mm		
<b>Silber rhodin.</b>	Art.-No.	-		<b>495 075</b>
	VPE	-		1
				<b>496 032</b>
				1
<b>Silber vergoldet</b>	Art.-No.	-		<b>495 375</b>
	VPE	-		1
				<b>496 332</b>
				1
<b>Gelbgold GG 585</b>	Art.-No.	<b>495 274</b>		<b>495 275</b>
	VPE	1	-	1
				<b>496 232</b>
				1
<b>Weißgold WG 585</b>	Art.-No.	<b>495 674</b>		<b>495 675</b>
	VPE	1	-	1
				<b>496 632</b>
				1

Federringe,  
Karabiner

Ohrstecker,  
Brisuren

Anhänger, Schlaufen,  
Sicherungen

Perlseide, Drähte,  
Zwischenteile

Schließen,  
Schnapper

Edelsteine,  
Schmucksteine



Perlen

Zargen,  
Chatons

Halbzeuge,  
Ketten



Hilfsmittel,  
Fachliteratur

### Doppelschließen rund Two-sided clasps, round





				
Ausführung / Execution		matt ø 10,0 mm	poliert ø 11,0 mm	gerillt ø 11,0 mm
<b>Gelbgold GG 585</b>	Art.-No.	<b>496 206</b>	<b>496 205</b>	<b>496 208</b>
	VPE	1   -	1   -	1   -

### Doppelschließen oval Two-sided clasps, oval



				
Ausführung / Execution		zweifarbig B 10,0 x L 12,0 mm	poliert B 8,0 x L 11,0 mm	diamantiert B 8,0 x L 13,0 mm
<b>Silber rhodin.</b>	Art.-No.	<b>495 097</b>	<b>495 093</b>	<b>495 094</b>
	VPE	1   -	1   -	1   -

### Doppelschließen oval Two-sided clasps, oval

					
Ausführung / Execution		poliert			poliert, satiniert
		B 7,0 x L 9,0 mm	B 8,0 x L 11,0 mm	B 7,0 x L 9,0 mm	B 9,0 x L 13,0 mm
<b>Gelbgold GG 375</b>	Art.-No.	<b>496 167</b>	-	-	-
	VPE	1   -	-	-	-
<b>Gelbgold GG 585</b>	Art.-No.	<b>496 267</b>	<b>496 276</b>	<b>496 280</b>	<b>469 271</b>
	VPE	1   -	1   -	1   -	1   -
<b>Weißgold WG 585</b>	Art.-No.	<b>496 667</b>	-	-	-
	VPE	1   -	-	-	-





### Doppelschließen Fantasie Two-sided clasps, fantasy



Ausführung / Execution		matt		poliert	
		B 10,0 x L 12,0 mm	ø 10,0 mm	B 10,0 x L 12,0 mm	
<b>Silber rhodin.</b>	Art.-No. VPE	<b>495 095</b> 1   -		<b>495 096</b> 1   -	
<b>Silber vergoldet</b>	Art.-No. VPE	<b>495 395</b> 1   -		-	
<b>Gelbgold GG 585</b>	Art.-No. VPE	<b>496 287</b> 1   -		-	
				<b>496 246</b> 1   -	

### Doppelschließen Fantasie, mit Cubic Zirkonia Two-sided clasps, fantasy, with CZ stones



Ausführung / Execution		2 x 1 CZ		2 x 3 CZ	
		ø 10,0 x L 12,0 mm	ø 15,0 mm	B 7,5 x L 13,5 mm	
<b>Silber rhodin.</b>	Art.-No. VPE	<b>495 091</b> 1   -		<b>469 080</b> 1   -	
<b>Silber vergoldet</b>	Art.-No. VPE	<b>495 391</b> 1   -		-	
				<b>469 041</b> 1   -	

### Doppelschließen Fantasie Two-sided clasps, fantasy

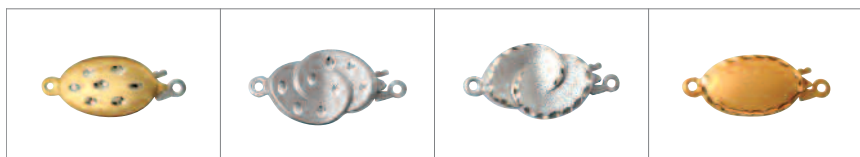

Ausführung / Execution		matt		mit Rand	
		B 8,2 x L 13,2 mm	B 10,0 x L 15,0 mm	B 10,0 x L 15,0 mm	B 8,0 x L 13,0 mm
<b>Silber rhodin.</b>	Art.-No. VPE	-	<b>496 068</b> 1   -	<b>496 066</b> 1   -	-
<b>Gelbgold GG 585</b>	Art.-No. VPE	<b>496 285</b> 1   -	-	<b>496 266</b> 1   -	-
<b>Rotgold RG 585</b>	Art.-No. VPE	-	-	-	<b>499 907</b> 1   -

Federringe,  
Karabiner

Ohrstecker,  
Brisuren

Anhänger, Schlaufen,  
Sicherungen

Perlseide, Drähte,  
Zwischenteile

Schließen,  
Schnapper

Edelsteine,  
Schmucksteine

Perlen

Zargen,  
Chatons

Halbzeuge,  
Ketten



Hilfsmittel,  
Fachliteratur

# Schmuckschließen

## Clasps

### Doppelschließen Fantasie, durchbrochen

Two-sided clasps, fantasy, openwork

			
Ausführung / Execution		durchbrochen	
		ø 12,0 x L 16,0 mm	ø 18,0 mm
Silber rhodin.	Art.-No.	469 040	
	VPE	1	-
Silber rhodin.	Art.-No.	495 066	
	VPE	1	-

### Doppelschließen eismatt und poliert

Two-sided clasps, icematt and polished



				
Ausführung / Execution		Stern	Würfel	Dreieck
		ø 13,0 mm	B 9,0 x H 9,0 mm	B 14,0 x H 14,0 mm
Silber AG 925	Art.-No.	469 090	469 091	469 092
	VPE	1	1	1
Silber vergoldet	Art.-No.	469 390	469 391	-
	VPE	1	1	-



### Bodenschließen 1-reihig

One-sided clasps, 1 row





Mit Cubic Zirkonia.

				
Ausführung / Execution		B 5,0 x L 12,0 mm	B 8,5 x L 15,0 mm	ø 12,0 mm
Silber rhodin.	Art.-No.	495 013	469 015	469 081
	VPE	1	1	1





### Bodenschließen mehrreihig

One-sided clasps, multiple row

					
Ausführung / Execution		gerieft	mit CZ		
		B 7,3 x L 10,0 mm	B 6,5 x L 14,5 mm	B 8,5 x L 15,0 mm	B 6,5 x L 14,5 mm
Silber rhodin.	Art.-No.	495 009	495 014	469 025	495 015
	VPE	1	1	1	1

### Perlbodenschließen 1-reihig





Pearl clasps, one sided, 1 row

				
Ausführung / Execution	ø 13,2 mm	ø 13,5 mm	B 11,0 x L 14,0 mm	
Silber rhodin.	Art.-No.	495 023	495 024	469 011
	VPE	1   -	1   -	1   -



### Perlbodenschließen 2-reihig



Pearl clasps, one sided, 2 row

					
Ausführung / Execution	ø 12,2 mm	ø 13,0 mm	ø 13,0 mm	B 11,0 x L 14,0 mm	
Silber rhodin.	Art.-No.	495 029	495 068	469 022	469 021
	VPE	1   -	1   -	1   -	1   -



### Perlbodenschließen 3-reihig

Pearl clasps, one sided, 3 row

				
Ausführung / Execution	mit CZ	ohne CZ		
	ø 17,5 mm	ø 16,0 mm	B 14,0 x L 16,0 mm	
Silber rhodin.	Art.-No.	469 034	469 033	469 031
	VPE	1   -	1   -	1   -



Federringe,  
Karabiner

Ohrstecker,  
Brisuren

Anhänger, Schlaufen,  
Sicherungen

Perlseide, Drähte,  
Zwischenteile

Schließen,  
Schnapper

Edelsteine,  
Schmucksteine

Perlen

Zargen,  
Chatons

Halbzeuge,  
Ketten

Hilfsmittel,  
Fachliteratur



Frei nach dem Motto

Vielfalt ist gut

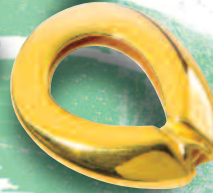

# Kreativität ist besser

Kombinieren Sie die Steck-Vorderverschlüsse nach Lust und Laune ...  
Gold mit Silber, matt mit glänzend oder vielleicht doch  
das Runde ins Eckige ... Ihrer Kreativität sind keine Grenzen gesetzt.

### Vorderverschlüsse bombiert Interlocking rings

1-farbig, 1-reihig.



Ausführ. / Execution	Ring-	matt/poliert	poliert	poliert
		ø 15,0 mm	ø 15,0 mm	L 40,0 mm
<b>Silber</b> <b>AG 925</b>	Art.-No.	-	<b>469 064</b>	<b>469 066</b>
	VPE	1   -	1   -	1   -
<b>Gelbgold</b> <b>GG 585</b>	Art.-No.	<b>469 256</b>	-	-
	VPE	1   -	-	-

### Vorderverschlüsse bombiert Interlocking rings

Gelb/weiß-Bicolor.  
1-reihig.



Ausführ. / Execution	Ring-	matt/poliert	gelb/weiß
		ø 15,0 mm	L 41,0 mm
<b>Silber</b> <b>AG 925 /</b> <b>vergoldet</b>	Art.-No.	<b>469 056</b>	<b>469 065</b>
	VPE	1   -	1   -

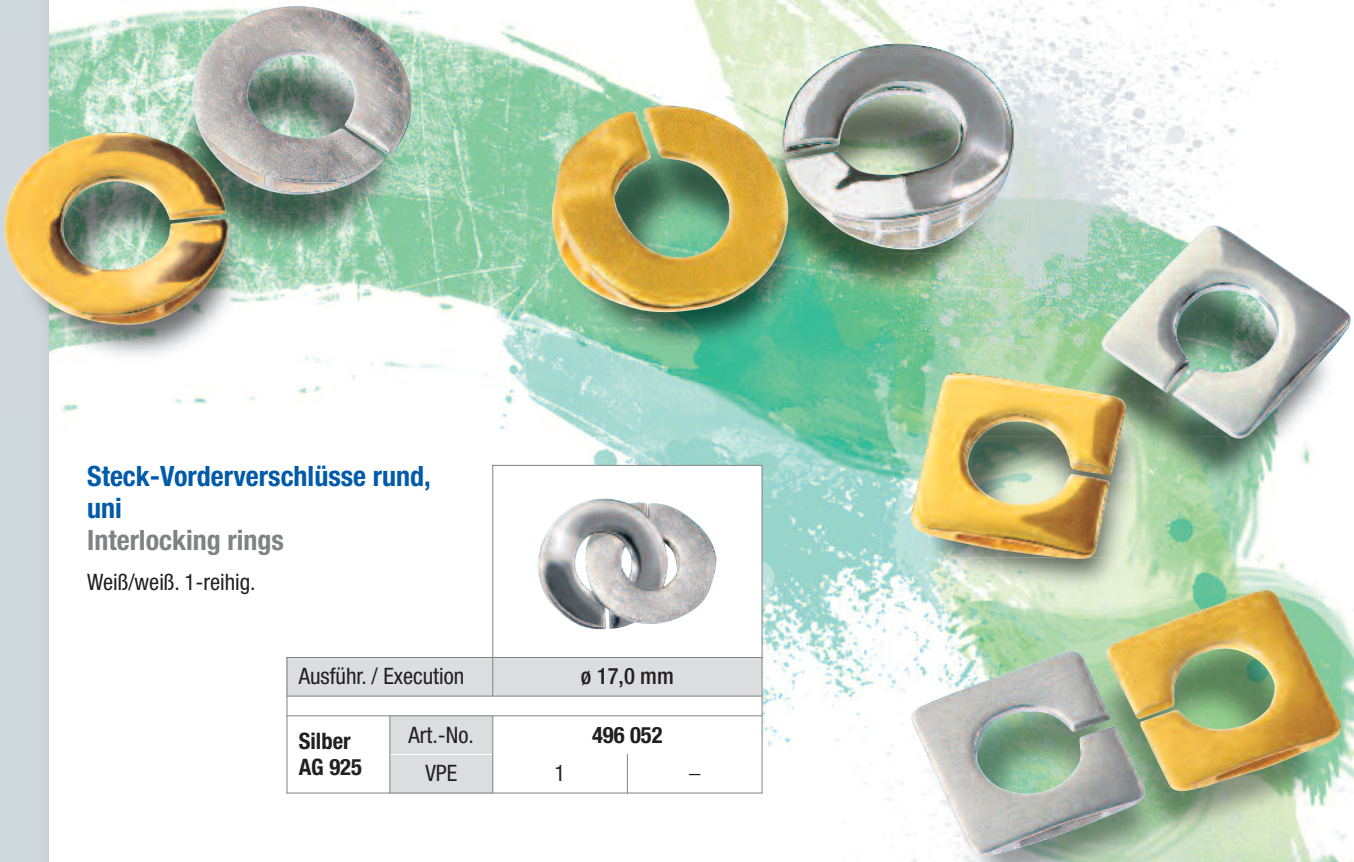

**Steck-Vorderverschlüsse rund,  
uni**  
Interlocking rings

Weiß/weiß. 1-reihig.



Ausführ. / Execution		ø 17,0 mm	
Silber AG 925	Art.-No.	496 052	
	VPE	1	-

**Steck-Vorderverschlüsse rund,  
flach**  
Interlocking rings

Gelb/weiß-Bicolor.  
1-reihig.



Ausführ. / Execution		ø 15,0 mm		ø 17,0 mm		ø 20,0 mm	
Silber AG 925 / vergoldet	Art.-No.	496 055		497 040		496 053	
	VPE	1	-	1	-	1	-

**Steck-Vorderverschlüsse rund,  
flach, 3-reihig**  
Interlocking rings, 3 row

Gelb/weiß-Bicolor.  
Mit Steg.



Ausführ. / Execution		ø 21,0 mm	
Silber AG 925 / vergoldet	Art.-No.	497 042	
	VPE	1	-

**Steck-Vorderverschlüsse  
eckig**  
Interlocking rings

Gelb/weiß-Bicolor.  
1-reihig.



Ausführ. / Execution		B 16,0 x L 16,0 mm	
Silber AG 925 / vergoldet	Art.-No.	497 041	
	VPE	1	-

Federlinge,  
Karabiner

Ohrstecker,  
Brisuren

Anhänger, Schlaufen,  
Sicherungen

Perlseide, Drähte,  
Zwischenteile

Schließen,  
Schnapper

Edelsteine,  
Schmucksteine

Perlen

Zargen,  
Chatons

Halbzeuge,  
Ketten

Hilfsmittel,  
Fachliteratur

### Hakenverschlüsse – S-Schließen

#### S-hook clasps

Dekorativer Verschlusshaken, der zusammen mit zwei Binderingen oder Doppelösen eine leicht zu öffnende Abschlussvariante darstellt.

Ausführung / Execution		poliert			Gegenöse				
		L 12,0 mm	L 20,0 mm	L 30,0 mm	L 10,0 x B 5,0 mm				
<b>Silber AG 925</b>	Art.-No.	<b>478 080</b>		<b>478 081</b>		<b>478 082</b>		<b>470 078</b>	
	VPE	1	–	1	–	1	–	1	–
<b>Silber vergoldet</b>	Art.-No.	<b>478 380</b>		<b>478 381</b>		<b>478 382</b>		<b>470 378</b>	
	VPE	1	–	1	–	1	–	1	–





### Hakenverschlüsse – S-Schließen

#### S-hook clasps

Attraktive Verschlüsse, besonders geeignet für Steinketten-Kombinationen.



Ausführ. / Execution	Gesamt-	mit Endkappen-Fädelstege (innen mit Kreuzsteg zum Anknuten von Perlseide)		mit Endösen			
		Kappen-ø 6,0 mm	Kappen-ø 8,0 mm	Ösen-L 7,5 x B 6,0 mm			
		L 25,0 mm	L 32,0 mm	L 30,0 mm			
<b>Silber AG 925</b>	Art.-No.	<b>478 088</b>		<b>478 085</b>		<b>478 086</b>	
	VPE	1	–	1	–	1	–

### Varioschließen – Klemmverkürzer/Krokodilschließe

#### Vario clasps



Ausführung / Execution		ohne Öse	mit Öse		
		L 15,0 x B 8,0 mm	L 14,0 x B 6,5 mm		
<b>Silber AG 925</b>	Art.-No.	<b>478 040</b>		<b>478 041</b>	
	VPE	1	–	1	–
<b>Gelbgold GG 585</b>	Art.-No.	<b>478 240</b>		<b>478 241</b>	
	VPE	1	–	1	–

Federringe,  
Karabiner

Ohrstecker,  
Brisuren

Anhänger, Schlaufen,  
Sicherungen

Perlseide, Drähte,  
Zwischenteile

Schließen,  
Schnapper

Edelsteine,  
Schmucksteine

Perlen

Zargen,  
Chatons

Halbzeuge,  
Ketten

Hilfsmittel,  
Fachliteratur



### Knebelschließen, poliert

#### Ring and toggle clasps, polished

Einfacher und dennoch raffinierter Verschluss – besonders schön für Armbänder und schwere Ketten.

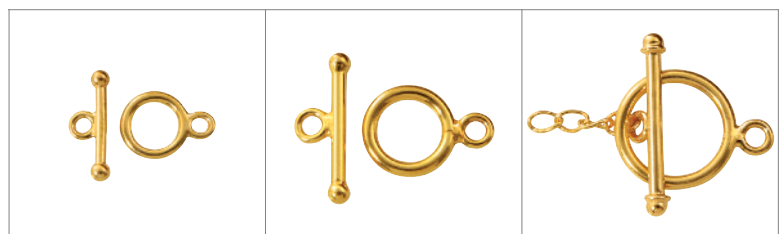

Ausführung / Execution		ø 9,0 mm	ø 12,0 mm	ø 16,0 mm
<b>Silber AG 925</b>	Art.-No.	<b>478 051</b>		<b>478 052</b>
	VPE	1	–	1
<b>Silber vergoldet</b>	Art.-No.	<b>478 351</b>		<b>478 352</b>
	VPE	1	–	1

Eine weitere KnebelschlieÙe finden Sie auf Seite 33.



### Karabinerverschlüsse mit Kette, poliert

#### Carabiner trigger clasps with extension chain

Für mehrreihige Armbänder mit Karabiner und Verlängerungskettchen.



Ausführ. / Execution	Steg-	2-reihig		3-reihig	
		B 19,0 mm		B 30,0 mm	
<b>Silber AG 925</b>	Art.-No.	<b>478 062</b>		<b>478 063</b>	
	VPE	1	-	1	-
<b>Silber vergoldet</b>	Art.-No.	<b>478 362</b>		<b>478 363</b>	
	VPE	1	-	1	-

### Karabinerverschlüsse mit Kette, poliert

#### Carabiner trigger clasps with extension chain

Für mehrreihige Armbänder mit Karabiner und Verlängerungskettchen.



Ausführ. / Execution	Steg-	2-reihig		3-reihig	
		B 11,0 mm		B 15,6 mm	
<b>Silber AG 925</b>	Art.-No.	<b>478 065</b>		<b>478 066</b>	
	VPE	1	-	1	-
<b>Silber vergoldet</b>	Art.-No.	<b>478 365</b>		<b>478 366</b>	
	VPE	1	-	1	-

Die separaten zwei- und dreireihigen Endteile finden Sie auf Seite 35.

Federringe,  
Karabiner

Ohrstecker,  
Brisuren

Anhänger, Schlaufen,  
Sicherungen

Perlseide, Drähte,  
Zwischenteile

Schließen,  
Schnapper

Edelsteine,  
Schmucksteine

Perlen

Zargen,  
Chatons

Halbzeuge,  
Ketten

Hilfsmittel,  
Fachliteratur

# Armbandschließen

## Clasps For Bracelets



**Armbandschließen matt**  
Clasps for bracelets matt

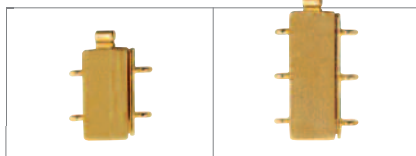

Ausführung / Execution		2-reihig		3-reihig	
		B 6,5 x L 12,4 mm		B 6,5 x L 17,2 mm	
<b>Silber AG 925</b>	Art.-No.	<b>499 060</b>		<b>499 061</b>	
	VPE	1	–	1	–
<b>Silber vergoldet</b>	Art.-No.	<b>499 360</b>		<b>499 361</b>	
	VPE	1	–	1	–

**Armbandschließen gerieft**  
Clasps for bracelets corrugated

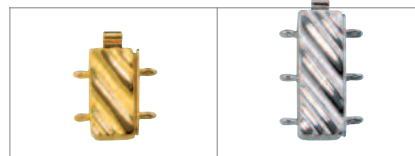

Ausführung / Execution		2-reihig		3-reihig	
		B 6,5 x L 12,0 mm		B 6,5 x L 17,3 mm	
<b>Silber AG 925</b>	Art.-No.	<b>499 062</b>		<b>499 063</b>	
	VPE	1	–	1	–
<b>Silber vergoldet</b>	Art.-No.	<b>499 362</b>		–	
	VPE	1	–	–	

**Armbandschließen eismatt-gemustert**  
Clasps for bracelets ice-matt patterned

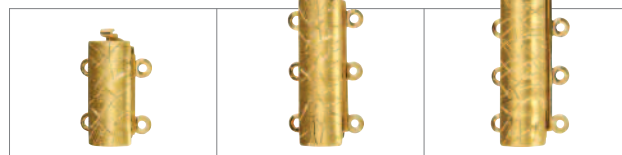

Ausführung / Execution		2-reihig		3-reihig		4-reihig	
		B 6,2 x L 14,5 mm		B 6,2 x L 20,6 mm		B 6,2 x L 25,5 mm	
<b>Silber rhodin.</b>	Art.-No.	<b>499 067</b>		<b>499 068</b>		<b>499 069</b>	
	VPE	1	–	1	–	1	–
<b>Silber vergoldet</b>	Art.-No.	<b>499 367</b>		<b>499 368</b>		<b>499 369</b>	
	VPE	1	–	1	–	1	–
<b>Gelbgold GG 585</b>	Art.-No.	<b>499 267</b>		<b>499 268</b>		<b>499 269</b>	
	VPE	1	–	1	–	1	–



### Armbandschließen poliert, gemustert Clasps for bracelets polished, patterned



Ausführung / Execution		2-reihig	3-reihig	4-reihig
		B 4,5 x L 11,0 mm	B 4,5 x L 17,0 mm	B 4,5 x L 22,0 mm
<b>Silber rhodin.</b>	Art.-No.	<b>499 077</b>	<b>499 078</b>	<b>499 079</b>
	VPE	1   -	1   -	1   -
<b>Silber vergoldet</b>	Art.-No.	<b>499 377</b>	<b>499 378</b>	<b>499 379</b>
	VPE	1   -	1   -	1   -

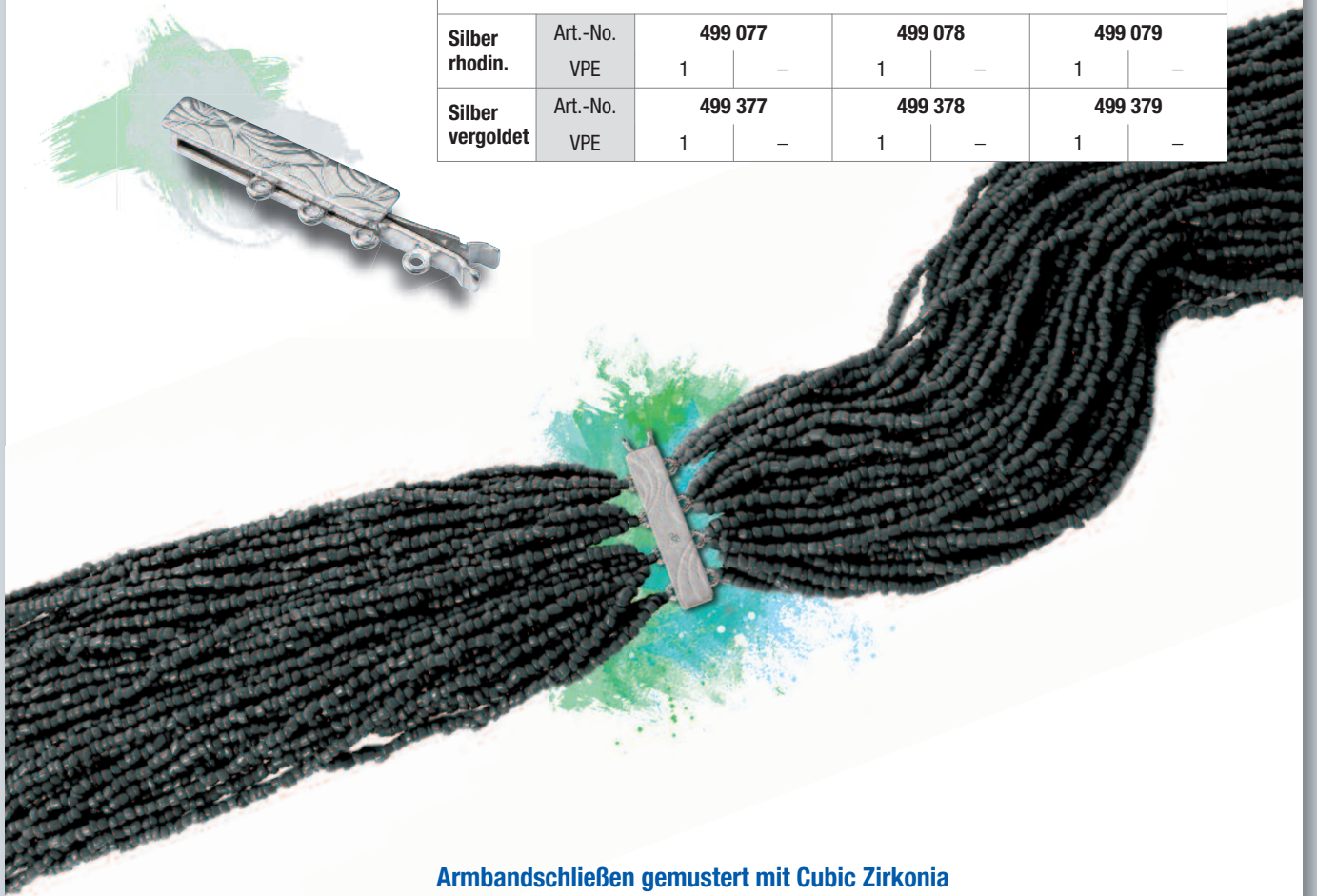

### Armbandschließen gemustert mit Cubic Zirkonia Slide-silver clasps patterned with CZ stone



Ausführung / Execution		2-reihig	3-reihig	4-reihig
		B 4,5 x L 11,0 mm	B 4,5 x L 17,0 mm	B 4,5 x L 22,0 mm
<b>Silber rhodin.</b>	Art.-No.	<b>499 072</b>	<b>499 073</b>	<b>499 074</b>
	VPE	1   -	1   -	1   -
<b>Silber vergoldet</b>	Art.-No.	<b>499 372</b>	<b>499 373</b>	<b>499 374</b>
	VPE	1   -	1   -	1   -

Federringe,  
Karabiner

Ohrstecker,  
Brisuren

Anhänger, Schlaufen,  
Sicherungen

Perlseide, Drähte,  
Zwischenteile

**Schließen,  
Schnapper**

Edelsteine,  
Schmucksteine

Perlen

Zargen,  
Chatons

Halbzeuge,  
Ketten





Hilfsmittel,  
Fachliteratur

# Armband-Kastenschließen



## Clasps For Bracelets



### Kastenschließen, schmale Form Box snaps, narrow shape

					
Ausführung / Execution		gemustert			poliert
		1-reihig	2-reihig	3-reihig	2-reihig
		B 6,0 x L 12,4 mm	B 8,4 x L 12,7 mm	B 8,4 x L 12,7 mm	B 8,6 x L 12,0 mm
<b>Silber AG 925</b>	Art.-No. VPE	<b>499 000</b> 1   -	<b>499 010</b> 1   -	<b>499 020</b> 1   -	<b>497 070</b> 1   -
<b>Silber vergoldet</b>	Art.-No. VPE	<b>499 300</b> 1   -	<b>499 310</b> 1   -	<b>499 320</b> 1   -	<b>497 370</b> 1   -

### Kastenschließen, breite Form Box snaps, wide shape

				
Ausführung / Execution		gemustert		poliert
		2-reihig	3-reihig	3-reihig
		L 12,9 x B 8,3 mm	L 12,9 x B 8,3 mm	L 11,6 x B 8,6 mm
<b>Silber AG 925</b>	Art.-No. VPE	<b>499 025</b> 1   -	<b>499 026</b> 1   -	<b>497 072</b> 1   -
<b>Silber vergoldet</b>	Art.-No. VPE	<b>499 325</b> 1   -	<b>499 326</b> 1   -	<b>497 372</b> 1   -

## Clasps For Bracelets

### Unterbau-Kastenschließen zum Unterlöten

Snap beds for soldering



Ausführung / Execution		B 4,0 mm	B 6,0 mm	B 8,0 mm	B 10,0 mm	B 12,0 mm
<b>Silber AG 925</b>	Art.-No.	<b>497 088</b>	<b>497 089</b>	<b>497 090</b>	<b>497 091</b>	<b>497 092</b>
	VPE	1   -	1   -	1   -	1   -	1   -
<b>Gelbgold GG 585</b>	Art.-No.	<b>497 288</b>	<b>497 289</b>	<b>497 290</b>	<b>497 291</b>	-
	VPE	1   -	1   -	1   -	1   -	-



### Kastenschließen ohne Ösen

Square clasps for bracelets without eye

Für Colliers und Armbänder mit Achtersicherung.

Ausführung / Execution		B 3,0 mm	B 4,0 mm	B 5,0 mm	B 6,0 mm
<b>Gelbgold GG 585</b>	Art.-No.	<b>499 230</b>	<b>499 231</b>	<b>499 232</b>	<b>499 233</b>
	VPE	1   -	1   -	1   -	1   -
<b>Gelbgold GG 750</b>	Art.-No.	<b>499 430</b>	<b>499 431</b>	<b>499 432</b>	-
	VPE	1   -	1   -	1   -	-

### Achtersicherung

Safety catch – figure of 8



Ausführung / Execution		L 11,5 mm
<b>Silber AG 925</b>	Art.-No.	<b>499 050</b>
	VPE	2   -
<b>Gelbgold GG 375</b>	Art.-No.	<b>499 150</b>
	VPE	1   -
<b>Gelbgold GG 585</b>	Art.-No.	<b>499 250</b>
	VPE	1   -
<b>Gelbgold GG 750</b>	Art.-No.	<b>499 450</b>
	VPE	1   -
<b>Weißgold WG 585</b>	Art.-No.	<b>499 650</b>
	VPE	1   -



Federlinge,  
Karabiner

Ohrstecker,  
Brisuren

Anhänger, Schlaufen,  
Sicherungen

Perlseide, Drähte,  
Zwischenteile

Schließen,  
Schnapper

Edelsteine,  
Schmucksteine

Perlen

Zargen,  
Chatons

Halbzeuge,  
Ketten

Hilfsmittel,  
Fachliteratur



# Drehverschlüsse

## Rotary Snaps

### Drehverschlüsse für Bernsteinketten Amber rotary snaps synthetic resin

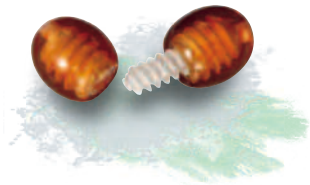
Drehverschlüsse aus Kunstharz.







			
Ausführung / Execution	Gelb matt ø 7,0 x L 17,0 mm	Cognac ø 7,0 x L 15,9 mm	Antik braun ø 7,0 x L 15,9 mm
<b>Bernit Kunstharz</b>	Art.-No. 498 010	498 011	498 012
VPE	1   -	1   -	1   -





### Drehverschlüsse aus Elfenbein Ivory rotary snaps

Aus echtem Mammut-Elfenbein.



				
Ausführung / Execution	Ellipsenform			Kugelform
	ø 4,0 x L 18,0 mm	ø 5,0 x L 18,0 mm	ø 6,0 x L 20,0 mm	ø 8,0 x L 15,0 mm
<b>Echt Elfenbein</b>	Art.-No. 498 020	498 021	498 022	498 025
VPE	1   -	1   -	1   -	1   -

### Kunststoffgewinde für Bernstein- und Elfenbein-Verschlüsse Thread in plastic for amber and ivory snaps

				
Ausführung / Execution	ø 2,5 mm	ø 3,0 mm	ø 3,5 mm	ø 4,0 mm
<b>Kunststoff</b>	Art.-No. 498 080	498 081	498 082	498 083
VPE	1   -	1   -	1   -	1   -

### Drehverschlüsse aus Metall Screw clasps metal

Schraubverschlüsse einfach.



Ausführung / Execution	ø 4,0 mm	
<b>Metall versilbert</b>	Art.-No. 498 900	
VPE	1   -	
<b>Metall vergoldet</b>	Art.-No. 498 800	
VPE	1   -	



### Innenmechanik zu Perlschlösschen Built-in mechanism for pearl clasps

Zum Einbauen.



Ausführung / Execution		zum Einbauen	
<b>Silber</b> AG 925	Art.-No.	<b>497 010</b>	
	VPE	1	–
<b>Gelbgold</b> GG 750	Art.-No.	<b>497 410</b>	
	VPE	1	–

## Wechselverschluss-Systeme

mit hochwertigen Furnituren. Die separat erhältlichen Einbaumechaniken können individuell in Schmuckstücke, Perlen und Steine eingesetzt werden.

Mit diesen Systemen lassen sich Kugelschließen schnell und einfach austauschen. Dadurch ergeben sich nahezu unbegrenzte Variations- und Kombinationsmöglichkeiten.

### Kugelpf-Endteile für Wechselmechanik „Nittel“ Endpart for interchangeable clasp system “Nittel”

Kugelpfchlüssel  
lang: zum Fädeln und  
kurz: zum Löten.



Ausführ. / Execution	Kugelschlüssel	lang 7,5 mm		kurz 5,0 mm	
		Schaft- ø 1,8 mm außen		ø 1,5 mm außen	
<b>Edelstahl</b>	Art.-No.	<b>498 875</b>		<b>498 876</b>	
	VPE	1	–	1	–
<b>Silber</b> AG 925	Art.-No.	<b>498 075</b>		<b>498 076</b>	
	VPE	1	–	1	–
<b>Gelbgold</b> GG 750	Art.-No.	<b>498 475</b>		<b>498 476</b>	
	VPE	1	–	1	–
<b>Weißgold</b> WG 750	Art.-No.	<b>498 975</b>		<b>498 976</b>	
	VPE	1	–	1	–

### Kugelpf-Federhülsen komplett mit Boden und Feder, System „Nittel“

Interchangeable clasps,  
system “Nittel”, ball type

Federhülsen mit Stahlfeder  
und Abdeckplättchen.



Ausf./Exec.	Außen- ø 3,4 x L 5,0 mm		
<b>Edelstahl</b>	Art.-No.	<b>498 874</b>	
	VPE	1	–
<b>Silber</b> AG 925	Art.-No.	<b>498 074</b>	
	VPE	1	–
<b>Gelbgold</b> GG 750	Art.-No.	<b>498 474</b>	
	VPE	1	–
<b>Weißgold</b> WG 750	Art.-No.	<b>498 974</b>	
	VPE	1	–

Federringe,  
Karabiner

Ohrstecker,  
Brisuren

Anhänger, Schlaufen,  
Sicherungen

Perlseide, Drähte,  
Zwischenteile

Schließen,  
Schnapper

Edelsteine,  
Schmucksteine

Perlen

Zargen,  
Chatons

Halbzeuge,  
Ketten

Hilfsmittel,  
Fachliteratur

# Wechselschließen

## Interchangeable Clasps

### Wechselschließen mit Kugelkopfmechanik Interchangeable clasps



				
Ausführung / Execution	Silizium ø 14,0 mm	Silber ø 14,0 mm	Silber/Palladium ø 15,0 mm	
<b>Silber AG 925</b>	Art.-No. VPE	<b>484 084</b> 1   -	<b>484 086</b> 1   -	<b>484 081</b> 1   -



### Wechselschließen mit Kugelkopfmechanik Interchangeable clasps, CZ stones

Mit Cubic Zirkonia.



				
Ausführung / Execution	Silber ø 12,0 mm	Stahl ø 13,0 mm	Silber ø 15,0 mm	Onyx ø 14,0 mm
<b>Edel- stahl</b>	Art.-No. VPE	<b>484 882</b> 1   -	-	-
<b>Silber AG 925</b>	Art.-No. VPE	<b>484 080</b> 1   -	<b>484 087</b> 1   -	<b>484 083</b> 1   -





### Wechselschließen mit Kugelkopfmechanik Interchangeable clasps

Kugel durchbrochen.

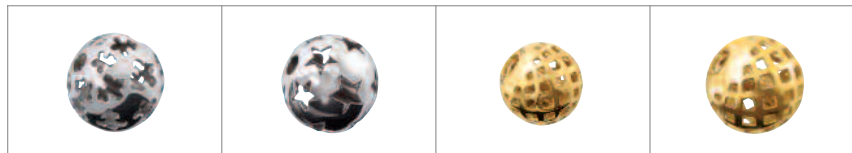

Ausführung / Execution		Ornament durchbrochen			
		Fleur de Lys	Stars	Raute	
		ø 13,0 mm	ø 13,0 mm	ø 11,0 mm	ø 13,0 mm
<b>Silber AG 925</b>	Art.-No.	<b>484 076</b>	<b>484 075</b>	-	-
	VPE	1   -	1   -		
<b>Gelbgold GG 585</b>	Art.-No.	-	-	<b>499 216</b>	<b>499 217</b>
	VPE			1   -	1   -



### Wechselschließen mit Kugelkopfmechanik Interchangeable clasps



Ausführung / Execution					2-farbig	0,08 ct (8 Br. W/SI)
		poliert	poliert	matt	matt	matt
		ø 11,0 mm	ø 13,0 mm	ø 11,0 mm	ø 11,0 mm	ø 11,0 mm
<b>Gelbgold GG 585</b>	Art.-No.	<b>484 290</b>	<b>484 293</b>	<b>484 291</b>	<b>484 292</b>	<b>499 213</b>
	VPE	1   -	1   -	1   -	1   -	1   -
<b>Weißgold WG 585</b>	Art.-No.	-	-	<b>484 691</b>	-	-
	VPE			1   -		

## Interchangeable Clasps

### Kreuzkopf-Bajonethülsen, System „Snapfix“ Interchangeable clasp system “Snapfix”

Bajonethülsen mit Feder und Abdeckplättchen.  
Komplett: zum Einkleben.  
Zerlegt: zum Löten.

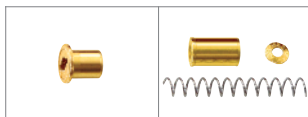

Ausführung / Execution		Federhülsen			
		komplett		zerlegt	
		Außen- $\varnothing$ 3,8 x L 4,8 mm		3-teilig	
<b>Gelbgold GG 585</b>	Art.-No.	<b>498 247</b>		<b>498 246</b>	
	VPE	1	–	1	–
<b>Gelbgold GG 750</b>	Art.-No.	<b>498 447</b>		<b>498 446</b>	
	VPE	1	–	1	–
<b>Weißgold WG 750</b>	Art.-No.	<b>498 947</b>		<b>498 946</b>	
	VPE	1	–	1	–

### Bohrer für Kreuzkopf-Bajonethülsen Drill for interchangeable clasp system



Ausf. / Execution		$\varnothing$ 3,8 mm	
<b>VHM</b>	Art.-No.	<b>568 195</b>	
	VPE	1	–

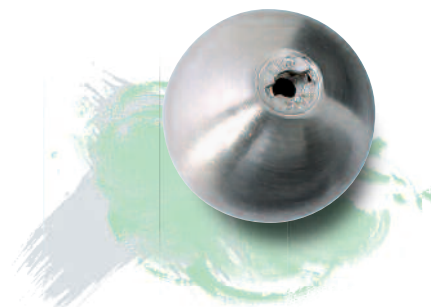

### Kreuzkopf-Endteile für Wechselmechanik „Snapfix“ Endpart for interchangeable clasp system “Snapfix”

Mit Hülse zum Einbau in Perlen ab  $\varnothing$  6,0 mm oder Edelsteine.



Ausführung / Execution		Schlüssel mit Hülse	Metall- hülsen lose
			<b>498 926</b>
		–	2   10
<b>Gelbgold GG 585</b>	Art.-No.	<b>498 230</b>	
	VPE	1	10
<b>Gelbgold GG 750</b>	Art.-No.	<b>498 430</b>	
	VPE	1	10
<b>Weißgold WG 585</b>	Art.-No.	<b>498 630</b>	
	VPE	1	10

### Bohrer für Kreuzkopf-Endteile Drill for interchangeable clasp system



Ausf. / Execution		$\varnothing$ 2,5 x L 5,0 mm	
<b>mit Anschl.</b>	Art.-No.	<b>568 199</b>	
	VPE	1	–

Und so funktioniert es:  
That's how it works:

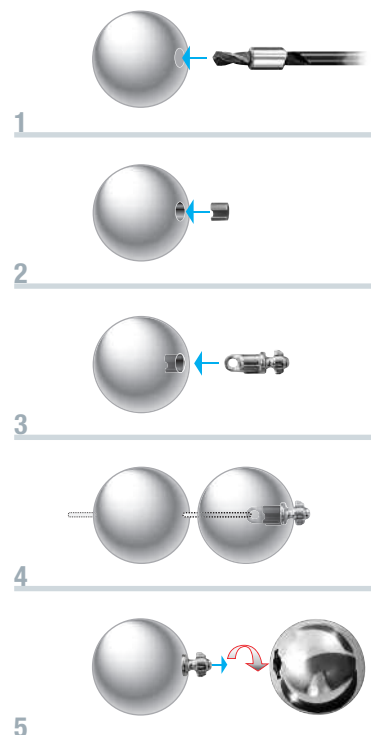

### Kreuzkopf-Endteile für Wechselmechanik „Snapfix“ Endpart for interchangeable clasp system “Snapfix”

Endteile für Kautschuk-, Silikon- oder Metallketten.  
Zum Anlöten oder mit Steg.

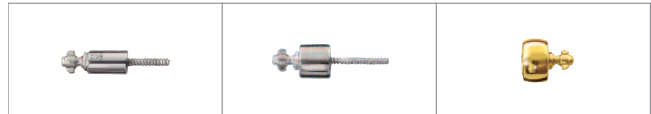

Ausführ. / Execution	Außen-	mit Gewinde	mit Stift	Endkappen
		Kautschuk	Metallkette	mit Steg
		ø 3,0 mm	ø 4,4 mm	ø 5,7 mm
<b>Silber AG 925</b>	Art.-No.	<b>498 072</b>		<b>498 027</b>
	VPE	1	-	1
<b>Gelbgold GG 585</b>	Art.-No.	-	-	<b>498 232</b>
	VPE	-	-	1
<b>Gelbgold GG 750</b>	Art.-No.	-	<b>498 427</b>	-
	VPE	-	1	-

### Kugelschließen für Kreuzkopf-Wechselmechanik „Snapfix“ Ball clasps for interchangeable clasp system “Snapfix”

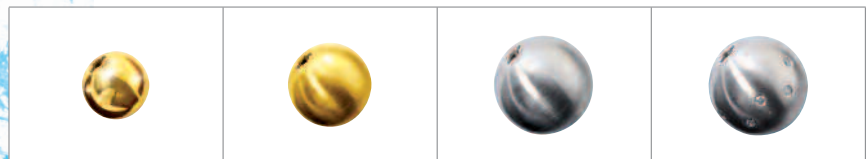

Ausführung / Execution	Art.-No.	poliert	matt	matt	mit Brillanten
		ø 9,0 mm	ø 11,0 mm	ø 13,0 mm	0,10 ct matt
		ø 9,0 mm	ø 11,0 mm	ø 13,0 mm	ø 13,0 mm
<b>Gelbgold GG 585</b>	Art.-No.	<b>498 240</b>	<b>498 239</b>	<b>498 236</b>	<b>498 243</b>
	VPE	1	-	1	-
<b>Weißgold WG 585</b>	Art.-No.	-	<b>498 639</b>	<b>498 636</b>	<b>498 643</b>
	VPE	-	1	-	1

Federringe,  
Karabiner

Ohrstecker,  
Brisuren

Anhänger, Schlaufen,  
Sicherungen

Perlseide, Drähte,  
Zwischenteile

Schließen,  
Schnapper

Edelsteine,  
Schmucksteine

Perlen

Zargen,  
Chatons

Halbzeuge,  
Ketten

Hilfsmittel,  
Fachliteratur

# Schnäpper für Schließen

## Bolts For Snaps

### Kastenschnäpper vertikal für Collierschließen, 1-reihig

Bolts for square snaps for necklets, 1 row

Ausführung / Execution		1-reihig				
		L 7,2 x B 1,5 mm	L 8,0 x B 1,8 mm	L 9,5 x B 2,0 mm	L 11,8 x B 2,2 mm	L 13,0 x B 2,2 mm
<b>Silber rhodin.</b>	Art.-No.	<b>494 008</b>	<b>494 009</b>	<b>494 010</b>	<b>494 011</b>	<b>494 012</b>
	VPE	2   -	2   -	2   -	2   -	2   -
<b>Silber vergoldet</b>	Art.-No.	<b>494 308</b>	<b>494 309</b>	<b>494 310</b>	-	<b>494 312</b>
	VPE	2   -	2   -	2   -	-	2   -
<b>Gelbgold GG 375</b>	Art.-No.	<b>494 108</b>	<b>494 109</b>	<b>494 110</b>	-	-
	VPE	1   -	1   -	1   -	-	-
<b>Gelbgold GG 585</b>	Art.-No.	<b>494 208</b>	<b>494 209</b>	<b>494 210</b>	<b>494 211</b>	<b>494 212</b>
	VPE	1   -	1   -	1   -	1   -	1   -
<b>Gelbgold GG 750</b>	Art.-No.	-	<b>494 409</b>	<b>494 410</b>	-	-
	VPE	-	1   -	1   -	-	-
<b>Weißgold WG 585</b>	Art.-No.	<b>494 608</b>	<b>494 609</b>	<b>494 610</b>	<b>494 611</b>	<b>494 612</b>
	VPE	1   -	1   -	1   -	1   -	1   -

### Kastenschnäpper vertikal für Collierschließen

Bolts for square snaps for necklets

Ausführung / Execution		1-reihig		2-reihig	3-reihig	2-reihig
		L 11,3 x B 3,4 mm	L 13,0 x B 5,05 mm	L 13,0 x B 5,0 mm	L 13,0 x B 5,0 mm	L 9,5 x B 7,0 mm
<b>Silber rhodin.</b>	Art.-No.	<b>494 940</b>	<b>494 941</b>	<b>494 951</b>	<b>494 960</b>	<b>494 950</b>
	VPE	2   -	2   -	2   -	2   -	2   -
<b>Silber vergoldet</b>	Art.-No.	<b>494 840</b>	<b>494 841</b>	<b>494 851</b>	-	<b>494 850</b>
	VPE	2   -	2   -	2   -	-	2   -

### Sortimente Haken- und Kastenschnäpper, 1-reihig

Assortments bolts for snaps, 1 row

Inhalt (sortiert in Box):

Je 6 x 2 Hakenschnäpper von L 10,0 bis 14,5 mm und B 4,5 bis 8,0 mm und je 4 x 2 Kastenschnäpper von L 7,2 bis 11,8 mm und B 1,5 x bis 2,2 mm.

Ausführung / Execution		Sortim./Assortments	Inhalt / Content
<b>Silber rhodin.</b>	Art.-No.	<b>494 090</b>	<b>20 Stück, davon 12 Haken- und 8 Kastenschnäpper</b>
	VPE	1   -	
<b>Silber vergoldet</b>	Art.-No.	<b>494 390</b>	<b>20 Stück, davon 12 Haken- und 8 Kastenschnäpper</b>
	VPE	1   -	





### Hakenschnäpper horizontal für Collierschließen, 1-reihig

Hook bolts for snaps for necklets, 1 row

						
Ausführung / Execution		1-reihig				
		L 10,0 x 4,5 mm	L 11,0 x B 4,5mm	L 9,5 x B 5,0 mm	L 13,0 x B 5,5 mm	L 13,5 x B 6,0 mm
<b>Silber rhodin.</b>	Art.-No. VPE	<b>494 080</b> 2   -	<b>494 081</b> 2   -	<b>494 082</b> 2   -	<b>494 083</b> 2   -	<b>494 001</b> 2   -
<b>Silber vergoldet</b>	Art.-No. VPE	<b>494 380</b> 2   -	<b>494 381</b> 2   -	<b>494 382</b> 2   -	<b>494 383</b> 2   -	<b>494 301</b> 2   -
<b>Gelbgold GG 585</b>	Art.-No. VPE	<b>494 280</b> 1   -	<b>494 281</b> 1   -	<b>494 282</b> 1   -	<b>494 283</b> 1   -	<b>494 201</b> 1   -
<b>Weißgold WG 585</b>	Art.-No. VPE	-	<b>494 681</b> 1   -	<b>494 682</b> 1   -	<b>494 683</b> 1   -	<b>494 601</b> 1   -
						
Ausführung / Execution		1-reihig				
		L 13,0 x B 6,0 mm	L 13,5 x B 6,0 mm	L 14,5 x B 8,0 mm	L 15,0 x B 8,0 mm	L 15,5 x B 8,0 mm
<b>Silber rhodin.</b>	Art.-No. VPE	<b>494 002</b> 2   -	<b>494 003</b> 2   -	<b>494 004</b> 2   -	<b>494 007</b> 2   -	<b>494 005</b> 2   -
<b>Silber vergoldet</b>	Art.-No. VPE	<b>494 302</b> 2   -	<b>494 303</b> 2   -	-	-	<b>494 305</b> 2   -
<b>Gelbgold GG 375</b>	Art.-No. VPE	<b>494 102</b> 1   -	<b>494 103</b> 1   -	-	-	-
<b>Gelbgold GG 585</b>	Art.-No. VPE	<b>494 202</b> 1   -	<b>494 203</b> 1   -	<b>494 204</b> 1   -	<b>494 207</b> 1   -	-
<b>Weißgold WG 585</b>	Art.-No. VPE	<b>494 602</b> 1   -	<b>494 603</b> 1   -	<b>494 604</b> 1   -	-	-

### Hakenschnäpper horizontal für Collierschließen, mehrreihig

Hook bolts for snaps for necklets, multiple row

					
Ausführung / Execution		2-reihig			3-reihig
		L 13,0 x B 8,5 mm	L 13,5 x B 9,5 mm	L 14,5 x B 8,5 mm	L 15,0 x B 8,5 mm
<b>Silber rhodin.</b>	Art.-No. VPE	<b>494 023</b> 2   -	<b>494 021</b> 2   -	<b>494 020</b> 2   -	<b>494 032</b> 2   -

Federringe,  
Karabiner

Ohrstecker,  
Brisuren

Anhänger, Schlaufen,  
Sicherungen

Perlseide, Drähte,  
Zwischenteile

**Schließen,  
Schnäpper**

Edelsteine,  
Schmucksteine

Perlen

Zargen,  
Chatons

Halbzeuge,  
Ketten

Hilfsmittel,  
Fachliteratur

# Münzfassungen glatt

## Coin Mountings

**Münzfassungen  
mit Kappen und Schlaufe, glatter Rand**  
Coin countings  
with loop and smooth hedge



Ausführung / Execution		Silber AG 925	Gelbgold GG 585	Passend für
ø 16,6 mm	Art.-No.	720 000 166	720 200 165	1 Pfennig, 1 Cent
	VPE	1   -	1   -	
ø 17,2 mm	Art.-No.	720 000 172	720 200 170	5 Goldmark
	VPE	1   -	1   -	
ø 19,0 mm	Art.-No.	-	720 200 190	5 Pfennig, 2 Cent
	VPE	-	1   -	
ø 20,1 mm	Art.-No.	720 000 200	720 200 200	10 Goldmark, 1 Dukate, 50 Pfennig, 10 Cent
	VPE	1   -	1   -	
ø 21,5 mm	Art.-No.	720 000 215	720 200 215	10 Pfennig, 5 Cent, 20 Schweizer Franken
	VPE	1   -	1   -	
ø 22,5 mm	Art.-No.	720 000 225	720 200 225	25 Goldmark, 2 Rand, 20 Cent
	VPE	1   -	1   -	
ø 24,2 mm	Art.-No.	720 000 242	720 200 250	25 Peseten, 50 Cent
	VPE	1   -	1   -	
ø 26,2 mm	Art.-No.	720 000 262	720 200 262	2 Euro, Gedenkmünzen
	VPE	1   -	1   -	
ø 27,0 mm	Art.-No.	-	720 200 270	2 DM
	VPE	-	1   -	
ø 28,2 mm	Art.-No.	720 000 280	-	50 französische Franc, 1 holländische Gulde
	VPE	1   -	-	
ø 29,5 mm	Art.-No.	720 000 295	720 200 300	5 DM
	VPE	1   -	1   -	
ø 31,0 mm	Art.-No.	720 000 310	-	100 chil. Pesos
	VPE	1   -	-	
ø 32,7 mm H 2,5 mm	Art.-No.	720 000 325	-	10 Euro
	VPE	1   -	-	
ø 33,0 mm H 3,0 mm	Art.-No.	720 000 330	720 200 330	Krüggerrand, 100 österr. Schilling
	VPE	1   -	1   -	
ø 34,5 mm	Art.-No.	720 000 340	-	20 US-Dollar
	VPE	1   -	-	
ø 36,2 mm	Art.-No.	720 000 362	-	1 Dollar, Gedenkmünzen
	VPE	1   -	-	
ø 38,2 mm	Art.-No.	720 000 382	720 200 382	Gedenkmünzen
	VPE	1   -	1   -	
ø 40,1 mm	Art.-No.	720 000 405	720 200 400	4 Dukaten, Gedenkmünzen
	VPE	1   -	1   -	
ø 41,3 mm	Art.-No.	720 000 415	-	Maria Theresia
	VPE	1   -	-	

**Münzfassungen mit Kappen und Schlaufe, Kordelrand**  
**Coin countings with loop and knurled hedge**



Ausführung / Execution		Silber AG 925	Gelbgold GG 585	Passend für
<b>ø 16,6 mm</b>	Art.-No. <b>720 002 166</b> VPE 1   -	-	-	1 Pfennig, 1 Cent
<b>ø 17,2 mm</b>	Art.-No. <b>720 002 172</b> VPE 1   -	-	-	5 Goldmark
<b>ø 19,0 mm</b>	Art.-No. - VPE -	-	-	5 Pfennig, 2 Cent
<b>ø 20,1 mm</b>	Art.-No. <b>720 002 200</b> VPE 1   -	-	<b>720 202 200</b> 1   -	10 Goldmark, 1 Dukate, 50 Pfennig, 10 Cent
<b>ø 21,5 mm</b>	Art.-No. <b>720 002 215</b> VPE 1   -	-	<b>720 202 220</b> 1   -	10 Pfennig, 5 Cent, 20 Schweizer Franken
<b>ø 22,5 mm</b>	Art.-No. <b>720 002 225</b> VPE 1   -	-	<b>720 202 225</b> 1   -	25 Goldmark, 2 Rand, 20 Cent
<b>ø 24,2 mm</b>	Art.-No. <b>720 002 242</b> VPE 1   -	-	-	25 Peseten, 50 Cent
<b>ø 26,2 mm</b>	Art.-No. <b>720 002 262</b> VPE 1   -	-	<b>720 202 260</b> 1   -	2 Euro, Gedenkmünzen
<b>ø 27,0 mm</b>	Art.-No. - VPE -	-	<b>720 202 270</b> 1   -	2 DM
<b>ø 28,2 mm</b>	Art.-No. <b>720 002 280</b> VPE 1   -	-	-	50 französische Franc, 1 holländische Gulde
<b>ø 29,5 mm</b>	Art.-No. <b>720 002 295</b> VPE 1   -	-	-	5 DM
<b>ø 31,0 mm</b>	Art.-No. <b>720 002 310</b> VPE 1   -	-	-	100 chil. Pesos
<b>ø 32,7 mm H 2,5 mm</b>	Art.-No. <b>720 002 325</b> VPE 1   -	-	-	10 Euro
<b>ø 33,0 mm H 3,0 mm</b>	Art.-No. <b>720 002 330</b> VPE 1   -	-	<b>720 202 330</b> 1   -	Krügerrand, 100 österr. Schilling
<b>ø 34,5 mm</b>	Art.-No. <b>720 002 340</b> VPE 1   -	-	-	20 US-Dollar
<b>ø 36,2 mm</b>	Art.-No. <b>720 002 362</b> VPE 1   -	-	-	1 Dollar, Gedenkmünzen
<b>ø 38,2 mm</b>	Art.-No. <b>720 002 382</b> VPE 1   -	-	-	Gedenkmünzen
<b>ø 40,1 mm</b>	Art.-No. <b>720 002 405</b> VPE 1   -	-	-	4 Dukaten, Gedenkmünzen
<b>ø 41,3 mm</b>	Art.-No. <b>720 002 415</b> VPE 1   -	-	-	Maria Theresia

Federringe, Karabiner  
 Ohrstecker, Brisuren  
 Anhänger, Schlaufen, Sicherungen  
 Perlschleife, Drähte, Zwischenteile  
**Schließen, Schnapper**  
 Edelsteine, Schmucksteine  
 Perlen  
 Zargen, Chatons  
 Halbzeuge, Ketten  
 Hilfsmittel, Fachliteratur

# Schlüsselringe

## Keyring Pendant



**Schlüsselringe rund,  
mit und ohne Panzerkette**  
Keyring pendants round



Ausführ. / Execution	Abmess.	ohne Kette		mit Kette	
		ø 21,0 mm		ø 21,0 x L 55,0 mm	
<b>Unecht versilbert</b>	Art.-No.	-		<b>480 902</b>	
	VPE	1		-	
<b>Silber AG 925</b>	Art.-No.	<b>480 001</b>		<b>480 002</b>	
	VPE	1	-	1	-

**Schlüsselringe Karabinerform,  
mit und ohne Kette**  
Keyring pendants shaped



Ausführ. / Execution	Abmess.	ohne Kette		mit Kette		ohne Kette		mit Kette	
		L 34,0 x B 20,0 mm		L 59,0 x B 20,0 mm		L 40,0 x B 26,0 mm		L 67,0 x B 26,0 mm	
<b>Unecht versilbert</b>	Art.-No.	<b>480 903</b>		<b>480 900</b>		<b>480 904</b>		<b>480 905</b>	
	VPE	1	-	1	-	1	-	1	-
<b>Silber AG 925</b>	Art.-No.	<b>480 003</b>		<b>480 000</b>		<b>480 004</b>		<b>480 005</b>	
	VPE	1	-	1	-	1	-	1	-

**Schlüsselringe ovale Form, mit und ohne Kette**  
Keyring pendants shaped



Ausführ. / Execution	Abmess.	ohne Kette		mit Kette	
		L 42,5 x B 23,0 mm		L 66,0 x B 23,0 mm	
<b>Silber AG 925</b>	Art.-No.	<b>480 006</b>		<b>480 007</b>	
	VPE	1	-	1	-



### Schlüsselpaltringe aus Flachdraht, abgerundet Keyrings round



Ausführ. / Execution	Innen-	ø 16,0 mm	ø 21,0 mm	ø 25,0 mm		
	Außen-	ø 20,0 mm	ø 26,0 mm	ø 30,0 mm		
<b>Silber AG 925</b>	Art.-No.	<b>483 020</b>		<b>483 021</b>	<b>483 022</b>	
	VPE	1	-	1	-	1

### Schlüsselringe Omega, mit und ohne Panzerkette Keyring pendants



Ausführ. / Execution	Abmess.	ohne Kette	mit Kette	
		ø 30,0 mm	ø 30,0 x L 68,0 mm	
<b>Silber AG 925</b>	Art.-No.	<b>480 014</b>		<b>480 024</b>
	VPE	1	-	1

### Schlüsselringe Fantasie, mit Kette Keyring pendant stylish with chain



Ausführ. / Execution	Abmess.	Karabiner	Klassik	Spannring		
		L 68,0 x B 20,5 mm	L 68,0 x B 26,0 mm	L 75,0 x 30,0 mm		
<b>Silber AG 925</b>	Art.-No.	<b>480 008</b>		<b>480 022</b>	<b>483 025</b>	
	VPE	1	-	1	-	1

Federlinge,  
Karabiner

Ohrstecker,  
Brisuren

Anhänger, Schlaufen,  
Sicherungen

Perlseide, Drähte,  
Zwischenteile

**Schließen,  
Schnapper**

Edelsteine,  
Schmucksteine

Perlen

Zargen,  
Chatons

Halbzeuge,  
Ketten

Hilfsmittel,  
Fachliteratur

# Taschenuhrketten

## Chains For Pocket Watches

### Taschenuhrketten Chains for pocket watches

Ketten-Länge: 25,0 cm.  
Federring-ø: 18,0 mm.  
Karabiner-Länge: 19,0 mm.



Ausführ. / Execution	Ketten-	Panzer	
		B ca. 4,1 mm	
<b>Eisen vernickelt</b>	Art.-No.	<b>487 000</b>	
	VPE	1	–
<b>Messing vergoldet</b>	Art.-No.	<b>487 800</b>	
	VPE	1	–
<b>Silber AG 925</b>	Art.-No.	<b>487 010</b>	
	VPE	1	–
<b>Silber oxidiert</b>	Art.-No.	<b>487 011</b>	
	VPE	1	–

### Taschenuhrketten Chains for pocket watches

Ketten-Länge: 25,0 cm.  
Federring-ø: 18,0 mm.  
Karabiner-Länge: 19,0 mm.



Ausführ. / Execution	Ketten-	Figaro	
		B ca. 5,3 mm	
<b>Eisen vernickelt</b>	Art.-No.	<b>487 901</b>	
	VPE	1	–
<b>Messing vergoldet</b>	Art.-No.	<b>487 801</b>	
	VPE	1	–

Einzelne TU-Karabiner finden Sie auf Seite 20 und  
TU-Federringe auf Seite 10.

### Uhrketten/Knopfketten Chains for pocket watches with button

Ketten-Länge: 23,0 cm.  
Knopf-ø: 13,0 mm.  
Karabiner-Länge: 19,0 mm.



Ausführ. / Execution	Ketten-	Panzer	
		B ca. 2,9 mm	
<b>Eisen vernickelt</b>	Art.-No.	<b>487 920</b>	
	VPE	1	–
<b>Messing vergoldet</b>	Art.-No.	<b>487 820</b>	
	VPE	1	–